

# EXPLODED DRAWING A—Model No. PFTL10909.1

R0910A

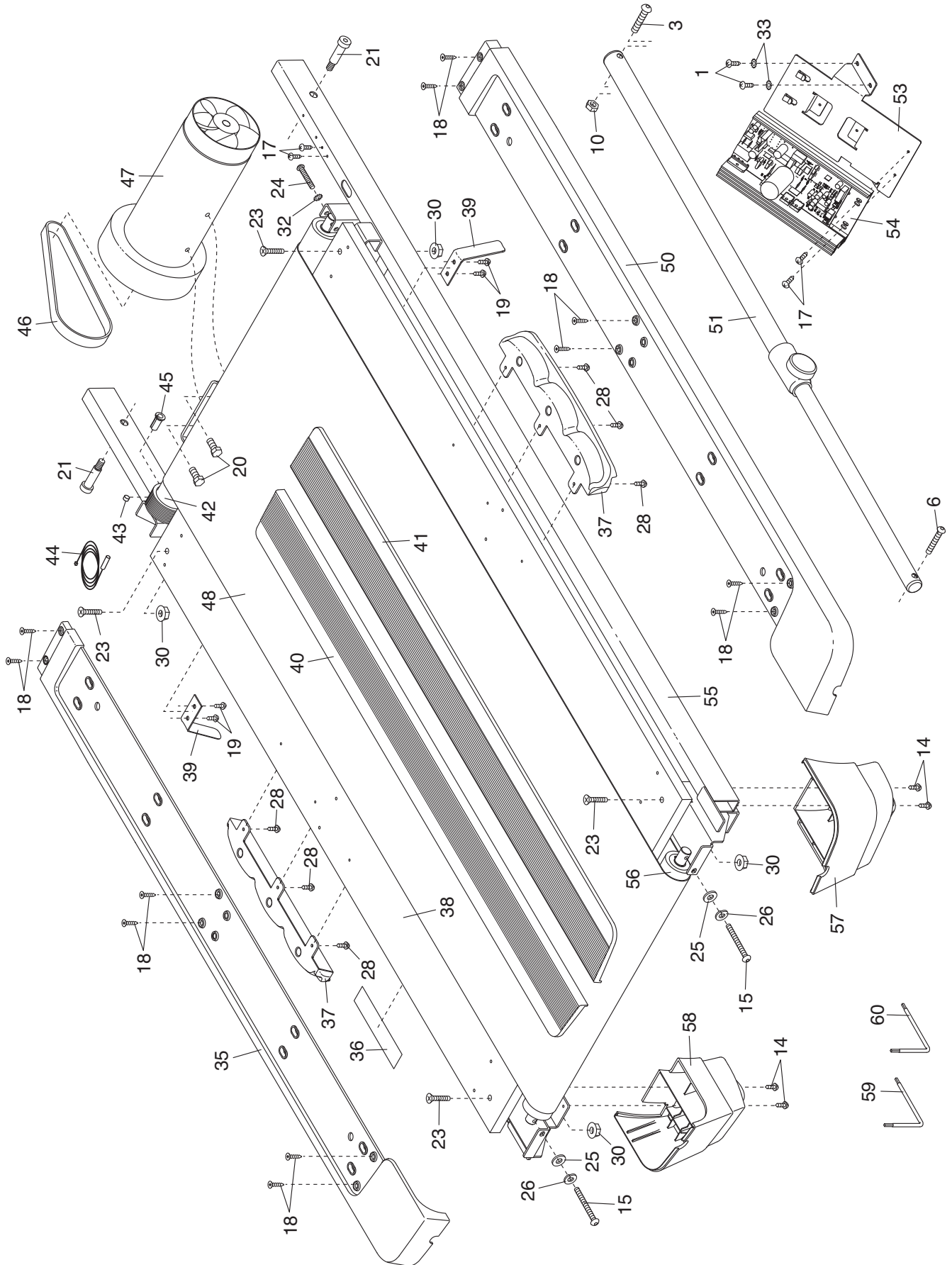

# EXPLODED DRAWING B—Model No. PFTL10909.1

R0910A

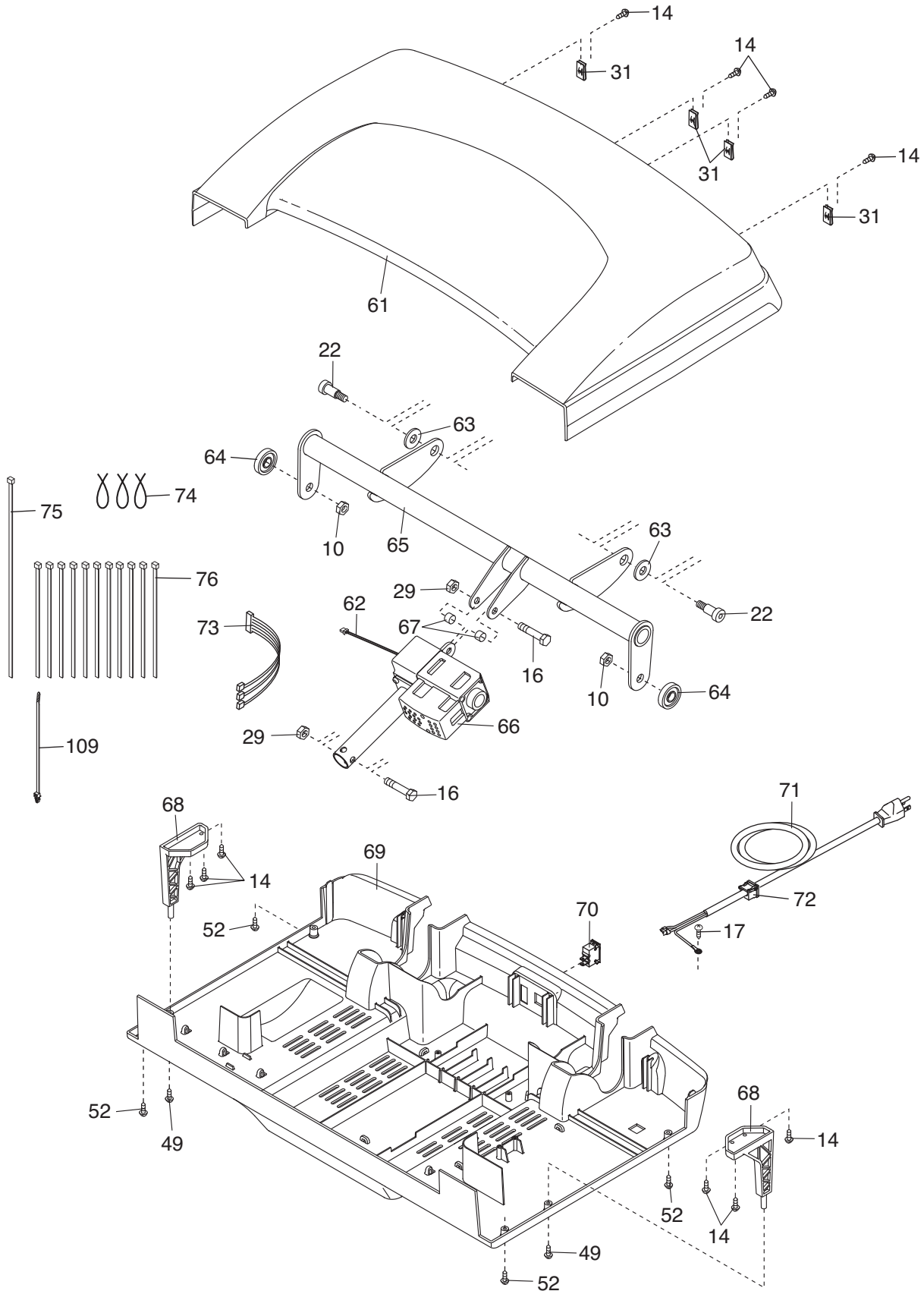

# EXPLODED DRAWING C—Model No. PFTL10909.1

R0910A

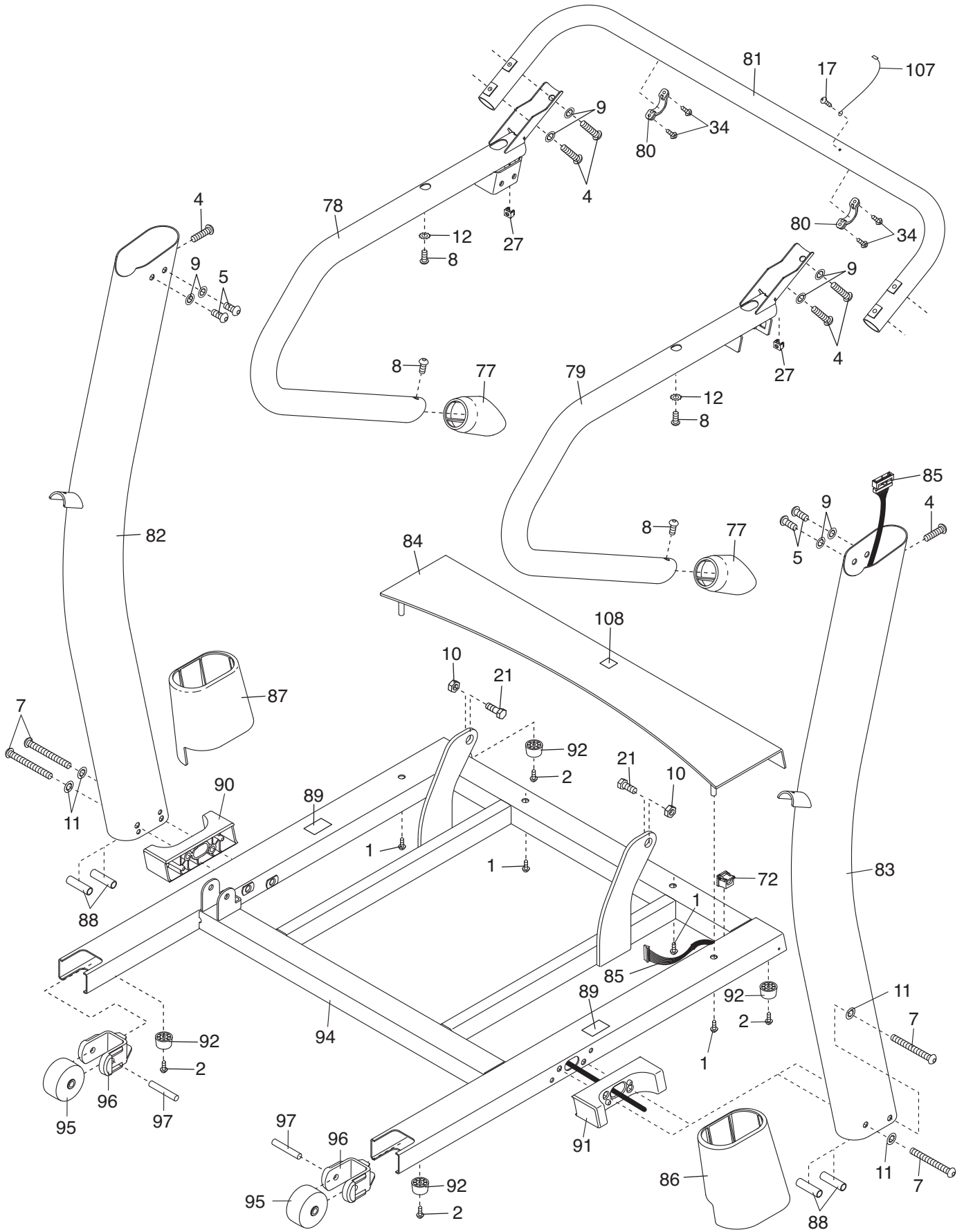

# EXPLODED DRAWING D—Model No. PFTL10909.1

R0910A

