

EXPLODED DRAWING A

Model No. PFTL10909.2 R0311A

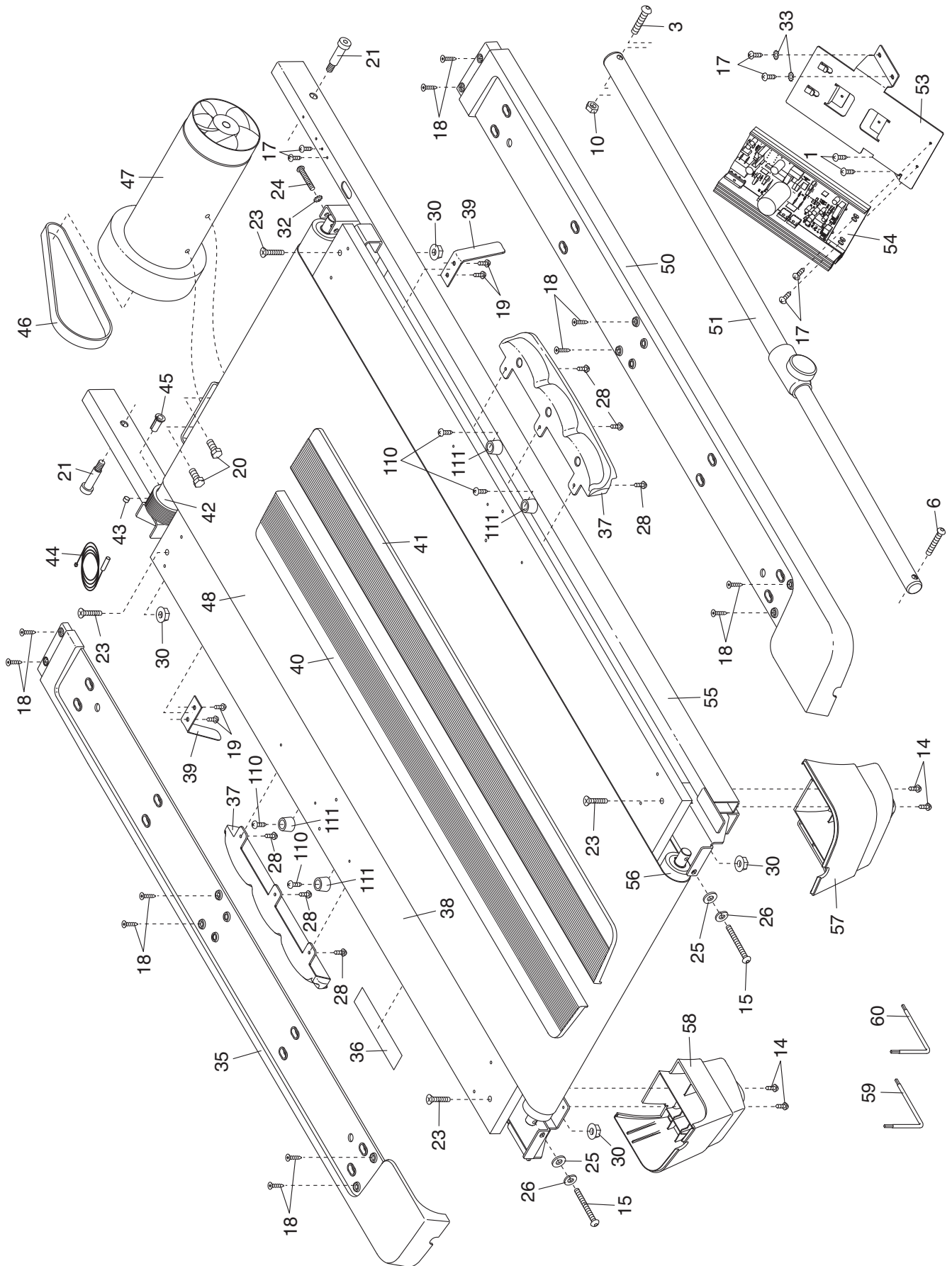

EXPLODED DRAWING B

Model No. PFTL10909.2 R0311A

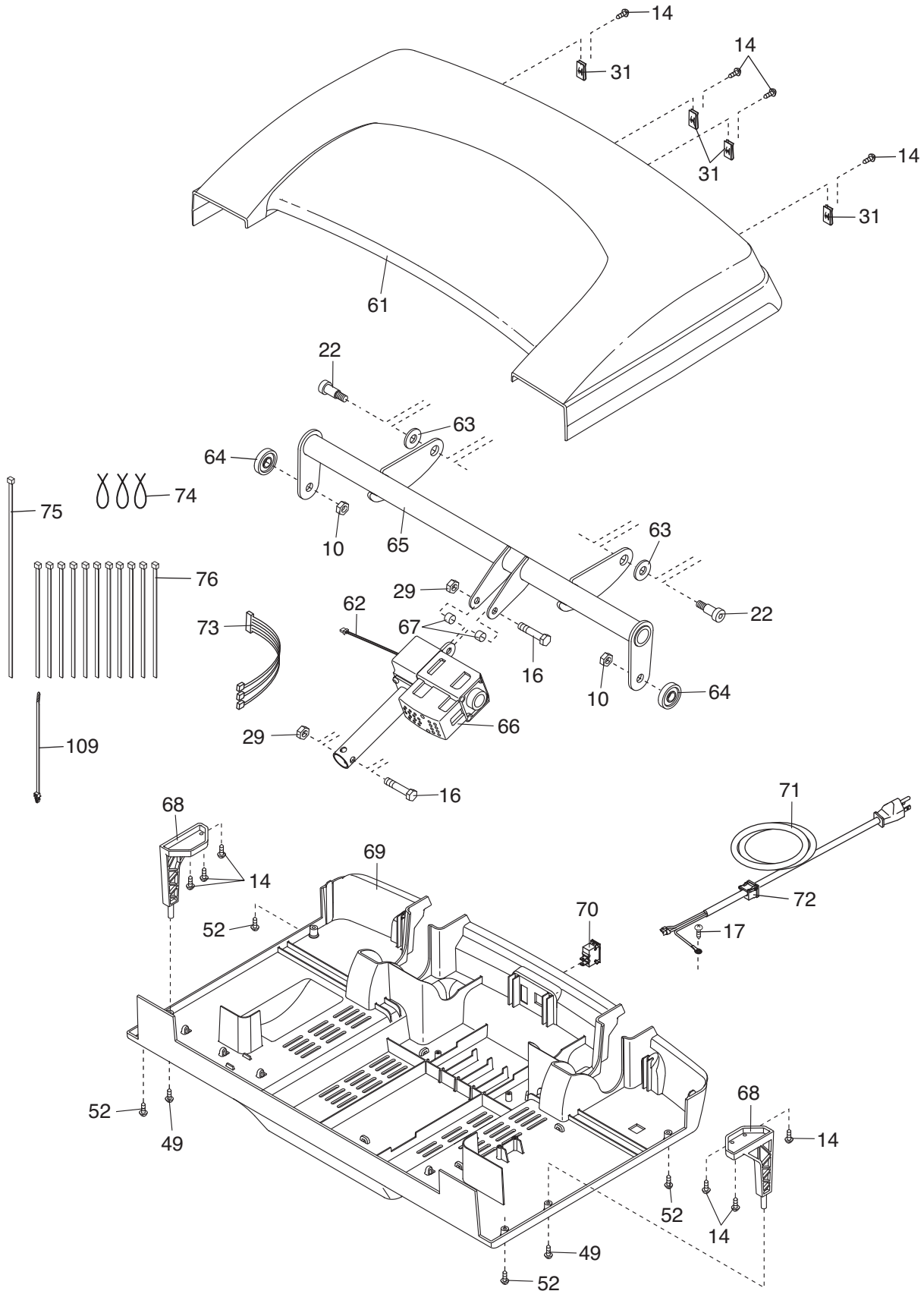

EXPLODED DRAWING C

Model No. PFTL10909.2 R0311A

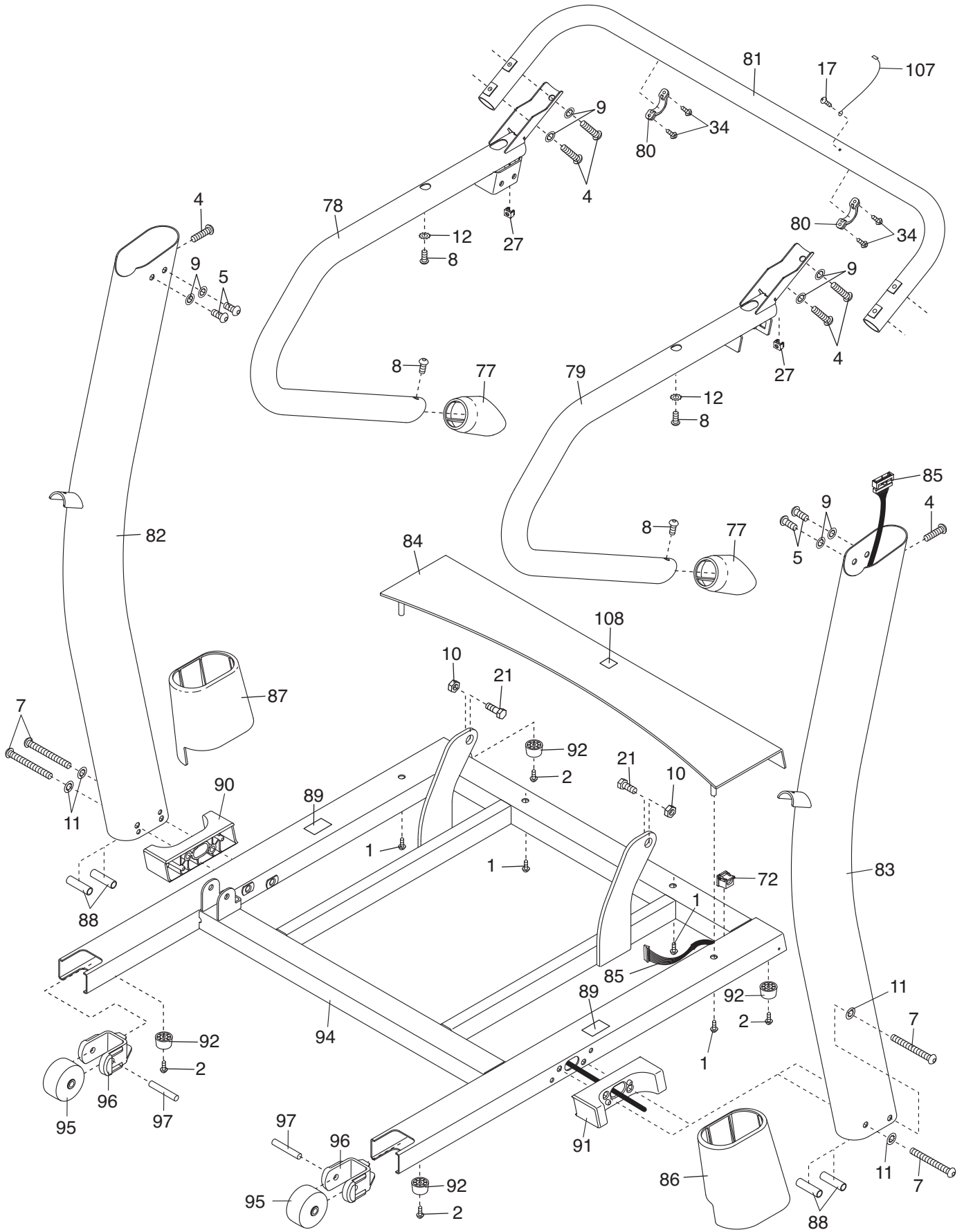

EXPLODED DRAWING D

Model No. PFTL10909.2 R0311A

