

EXPLODED DRAWING A

Model No. PFTL11011.3 R0714A

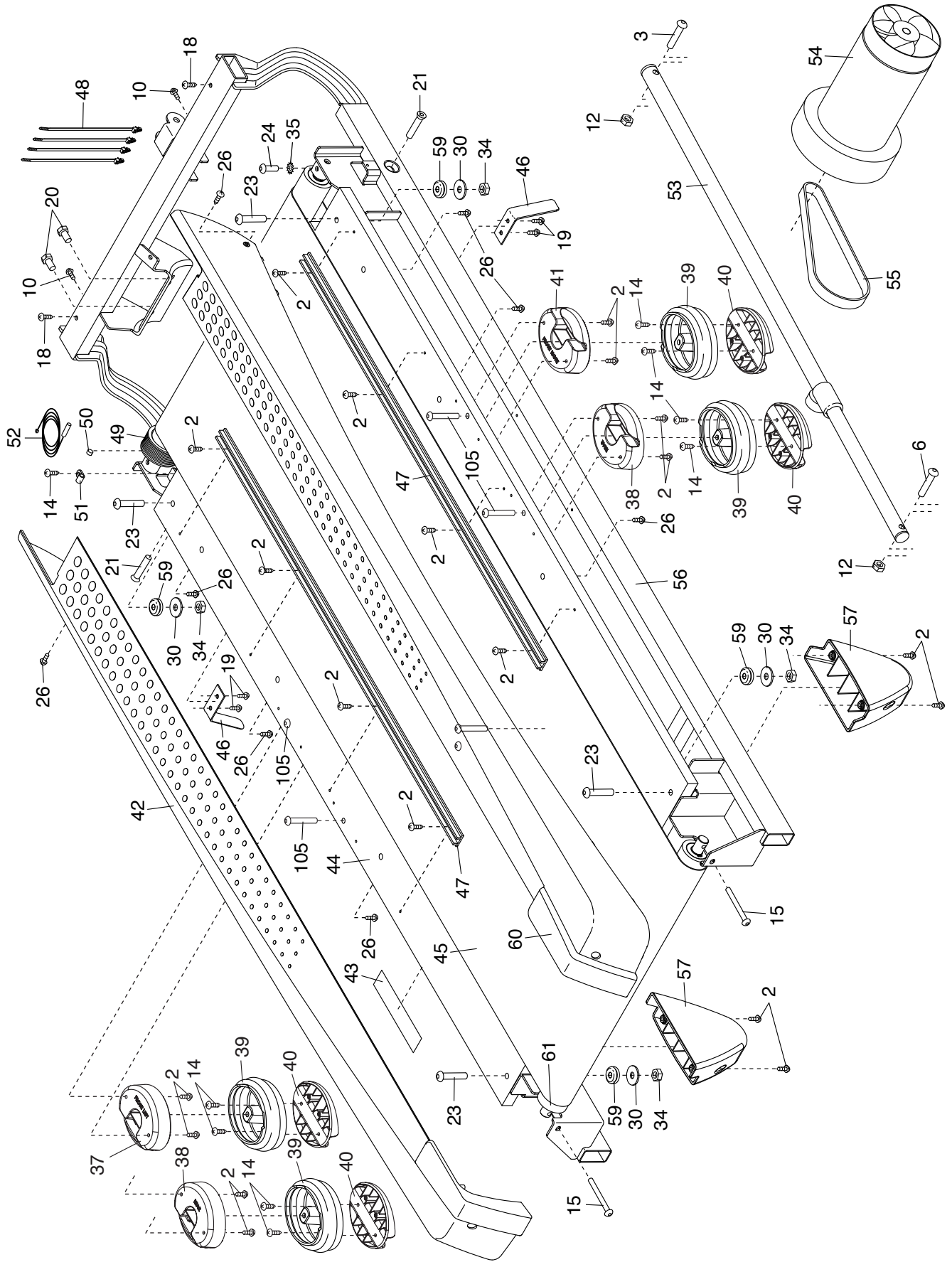

EXPLODED DRAWING B

Model No. PFTL11011.3 R0714A

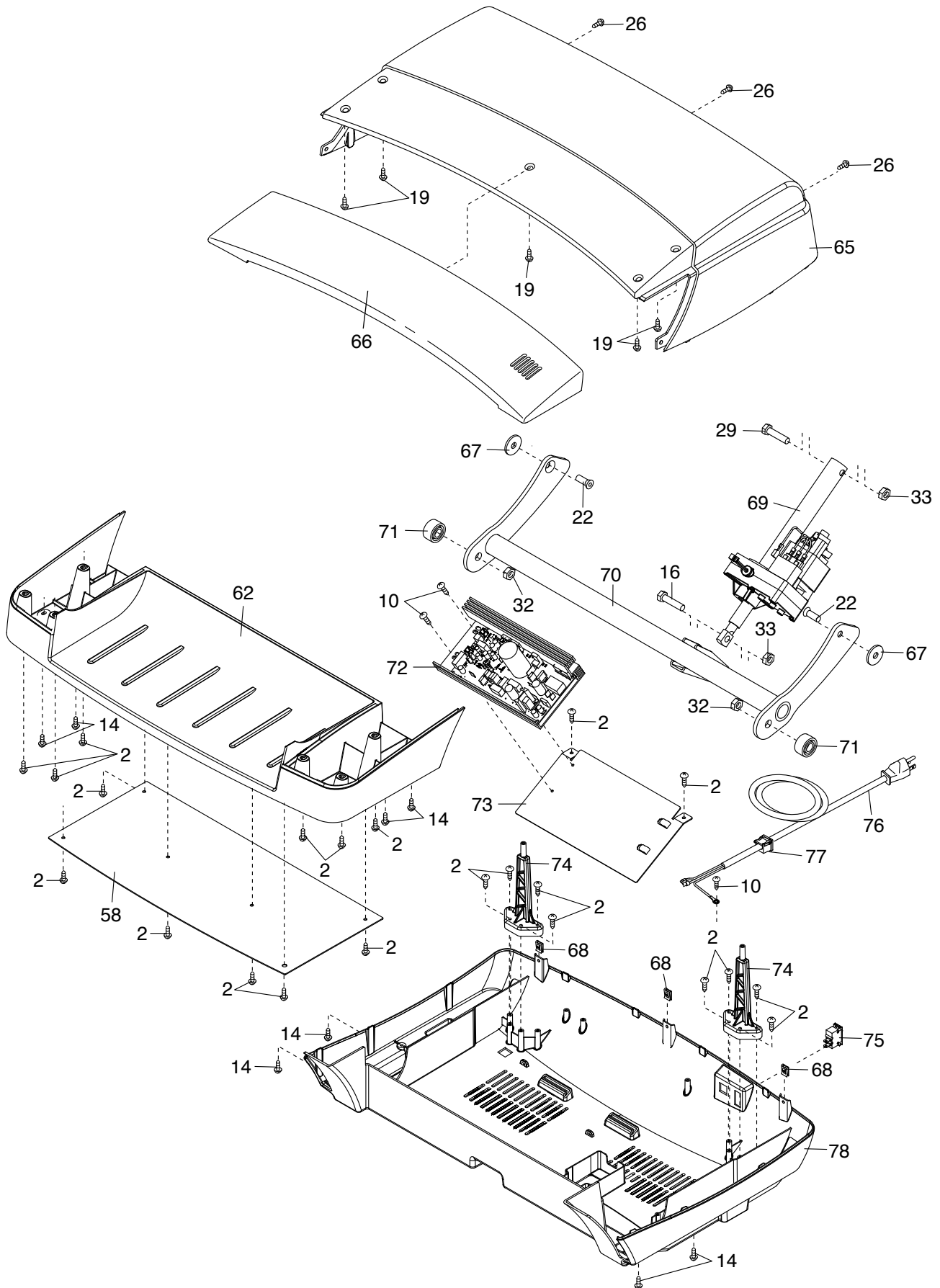

EXPLODED DRAWING C

Model No. PFTL11011.3 R0714A

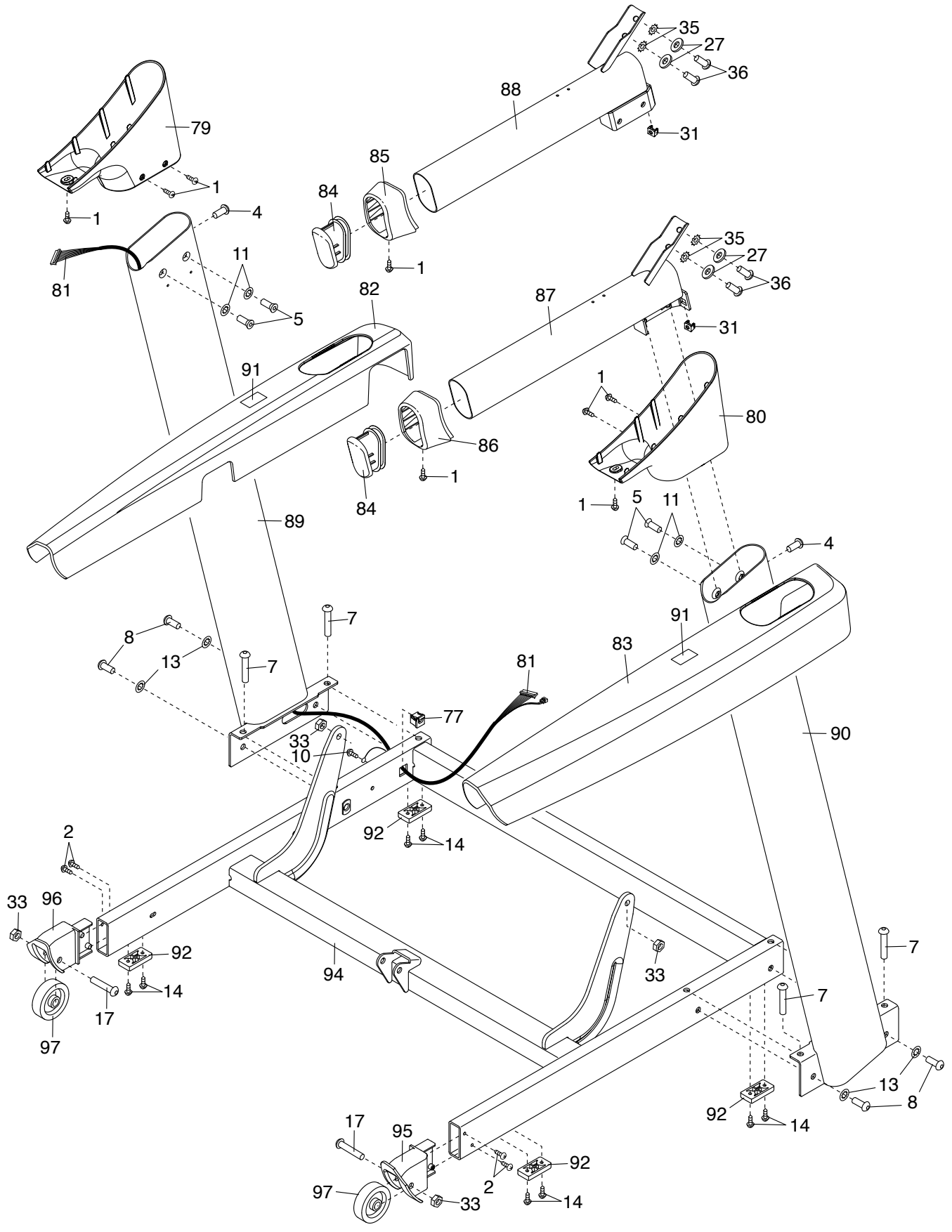

EXPLODED DRAWING D

Model No. PFTL11011.3 R0714A

