

# EXPLODED DRAWING A

Model No. PFTL11016.0 R0117A

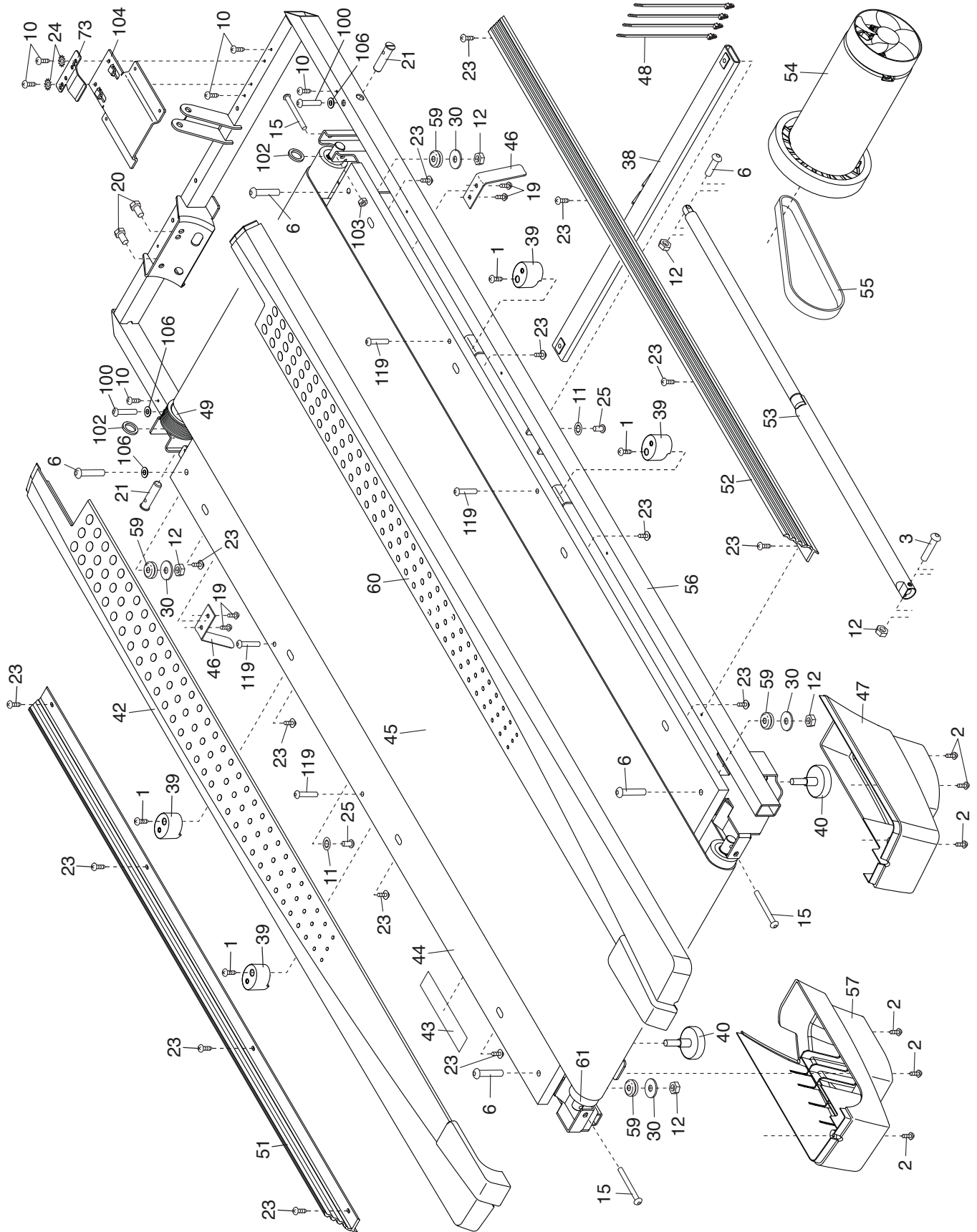

# EXPLODED DRAWING B

Model No. PFTL11016.0 R0117A

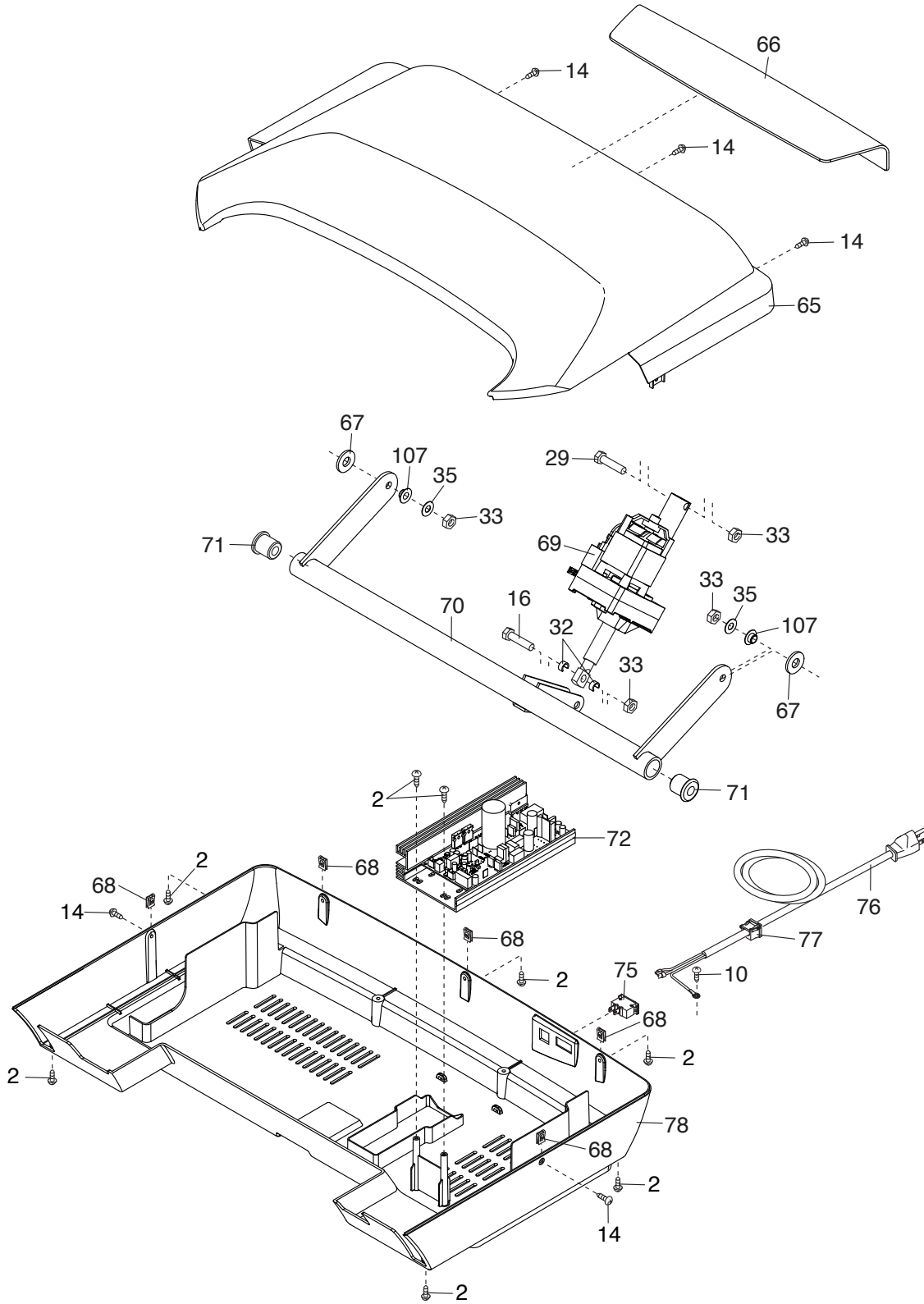

# EXPLODED DRAWING C

Model No. PFTL11016.0 R0117A

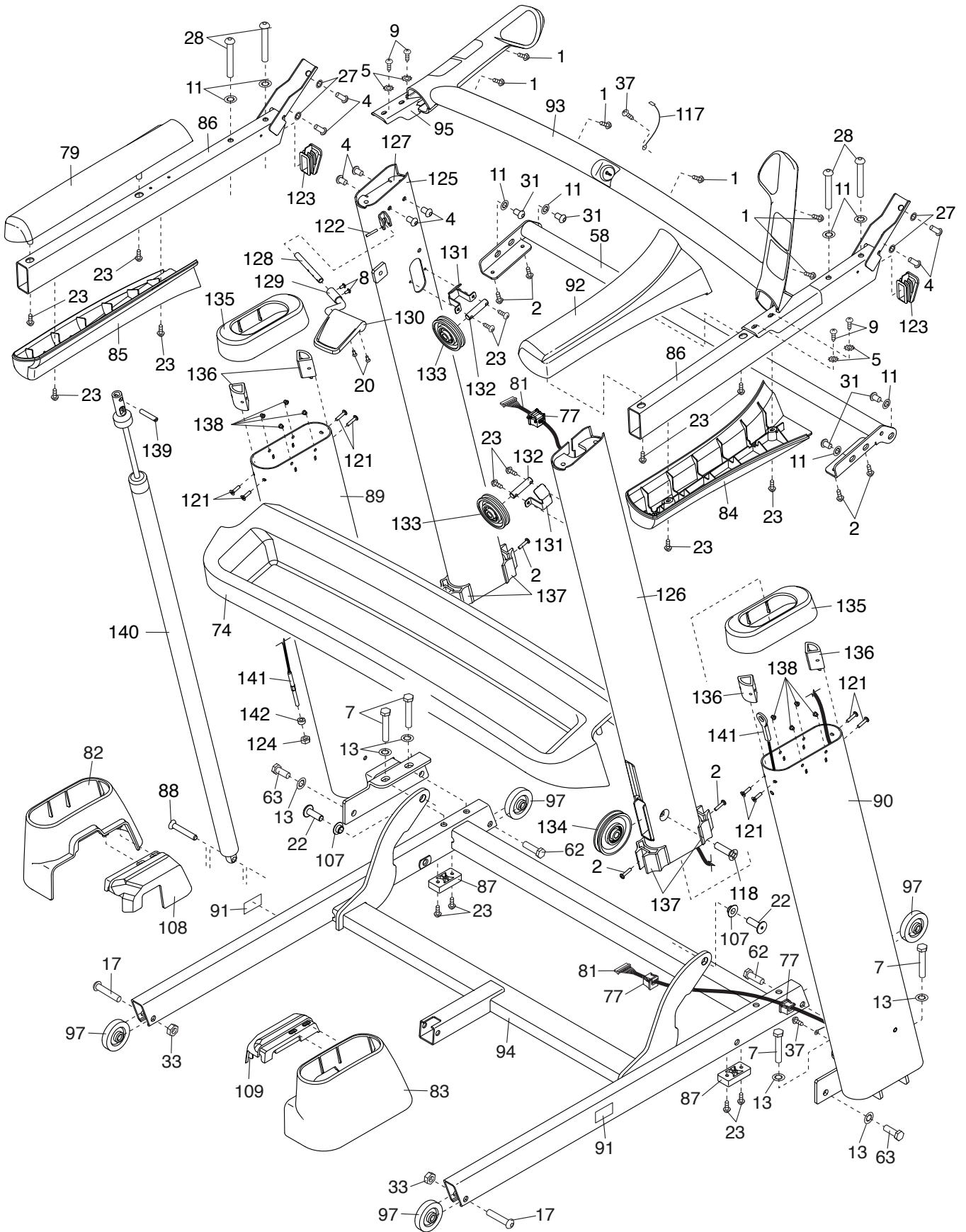

# EXPLODED DRAWING D

Model No. PFTL11016.0 R0117A

