

EXPLODED DRAWING A—Model No. PFTL12007.0

R0108A

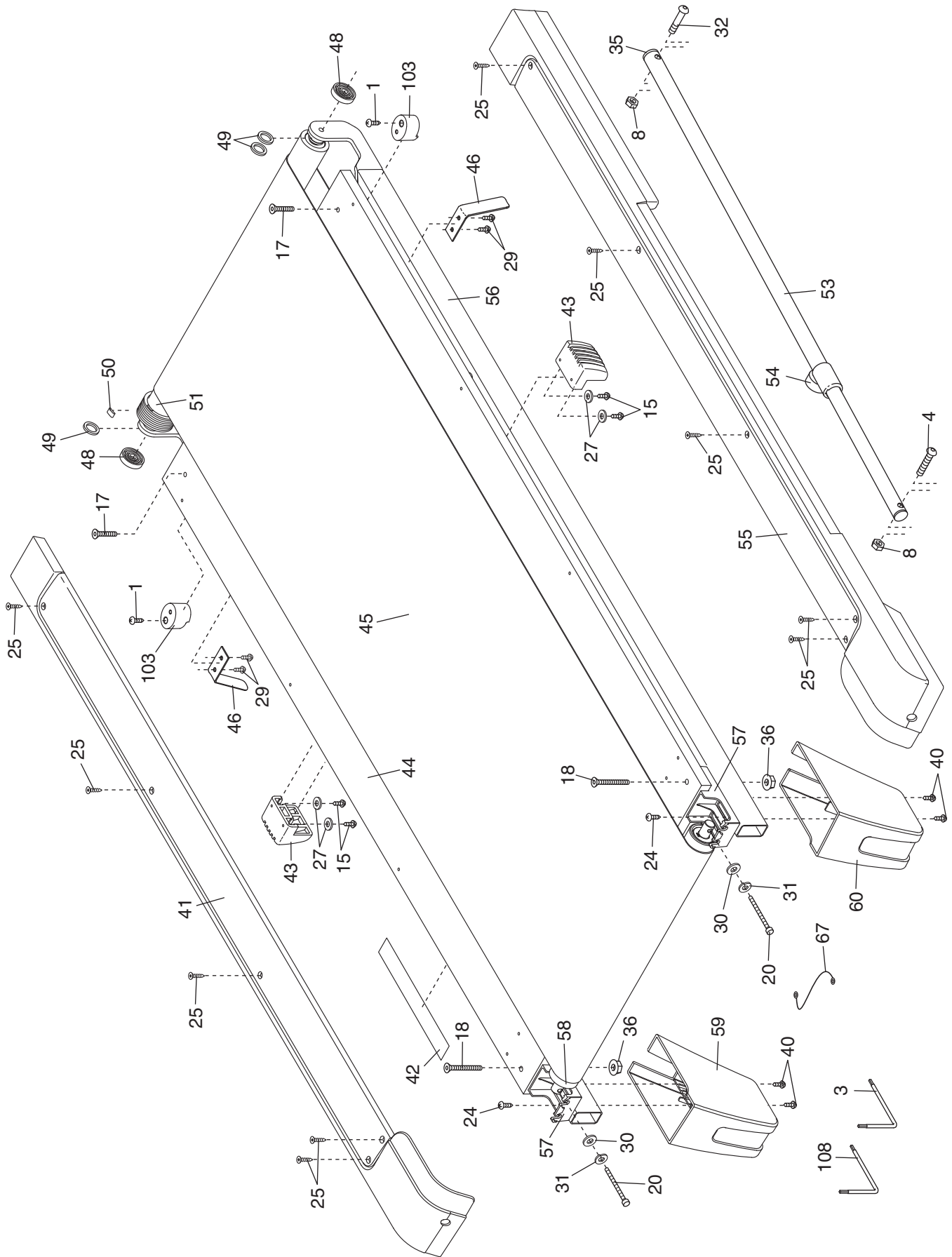

EXPLODED DRAWING B—Model No. PFTL12007.0

R0108A

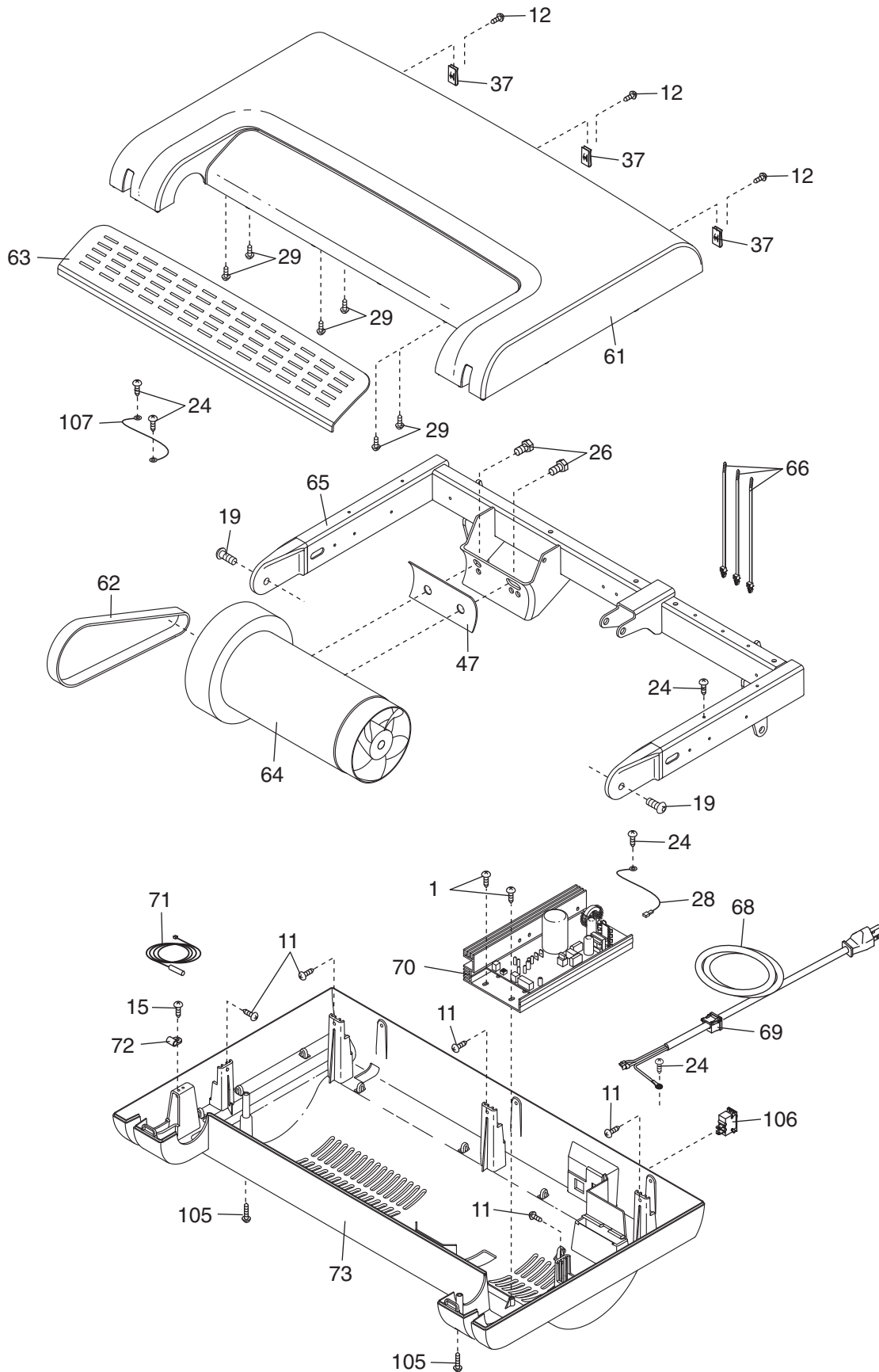

EXPLODED DRAWING D—Model No. PFTL12007.0

R0108A

