

# EXPLODED DRAWING A

Model No. PFTL12820.0 R1220A

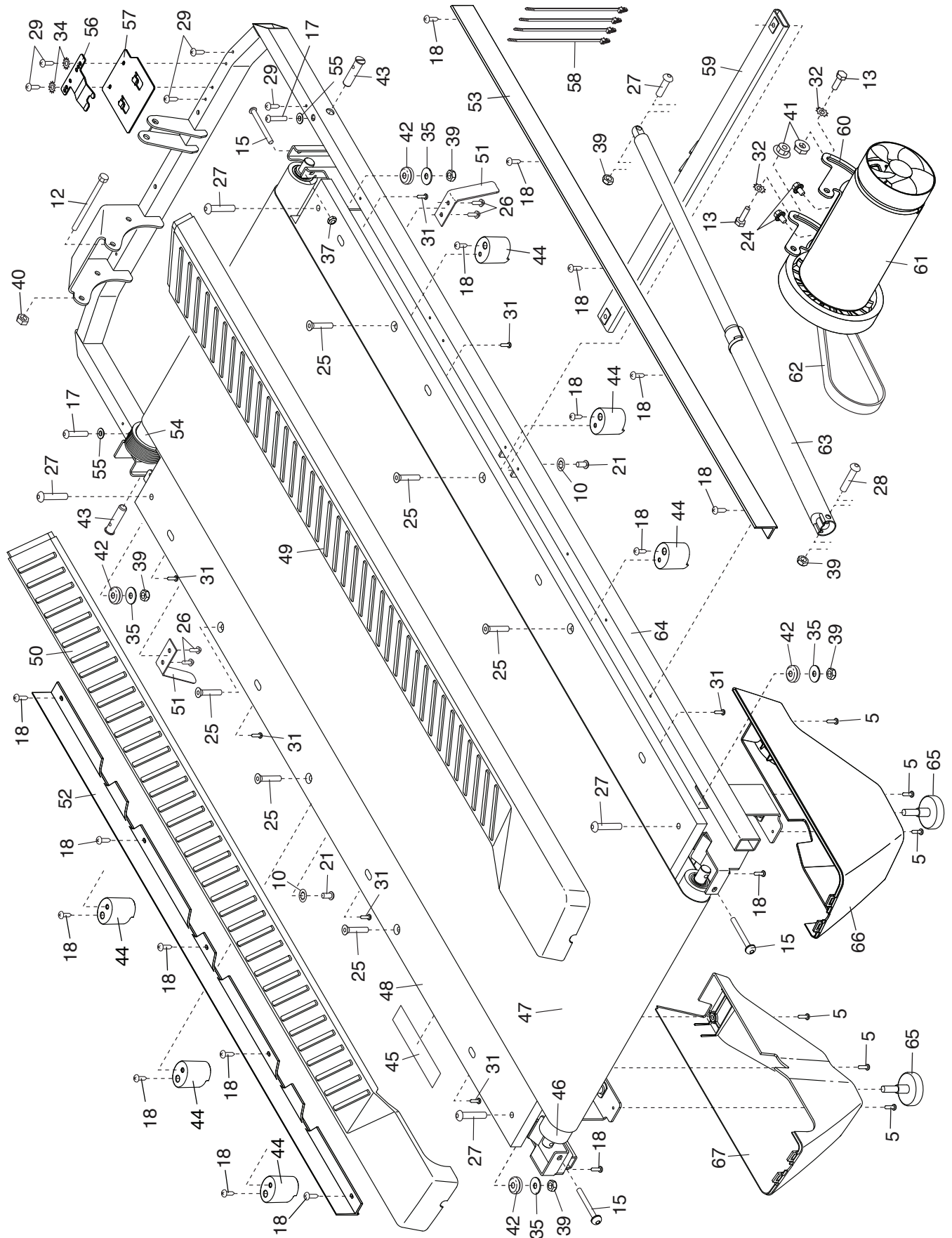

# EXPLODED DRAWING B

Model No. PFTL12820.0 R1220A

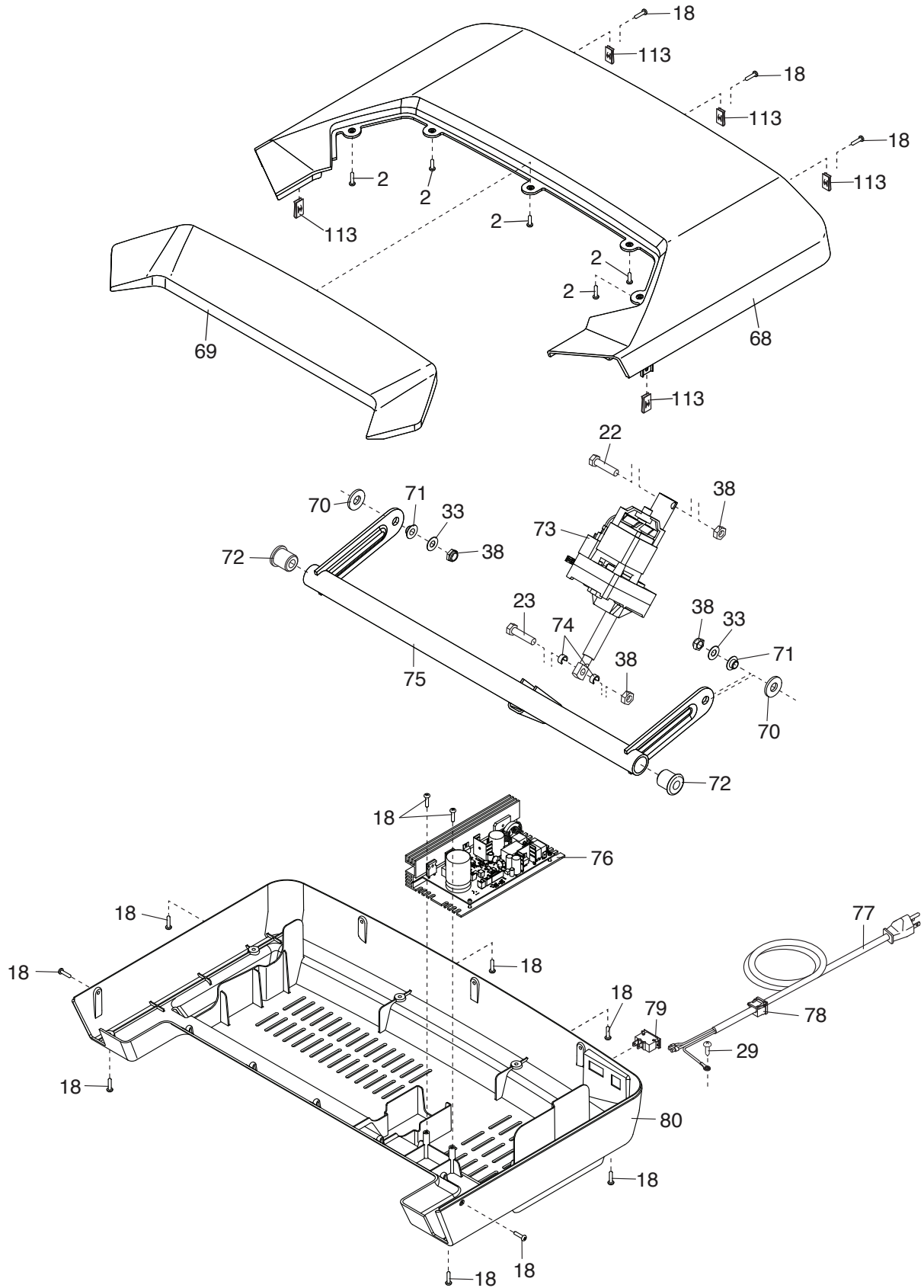

# EXPLODED DRAWING C

Model No. PFTL12820.0 R1220A

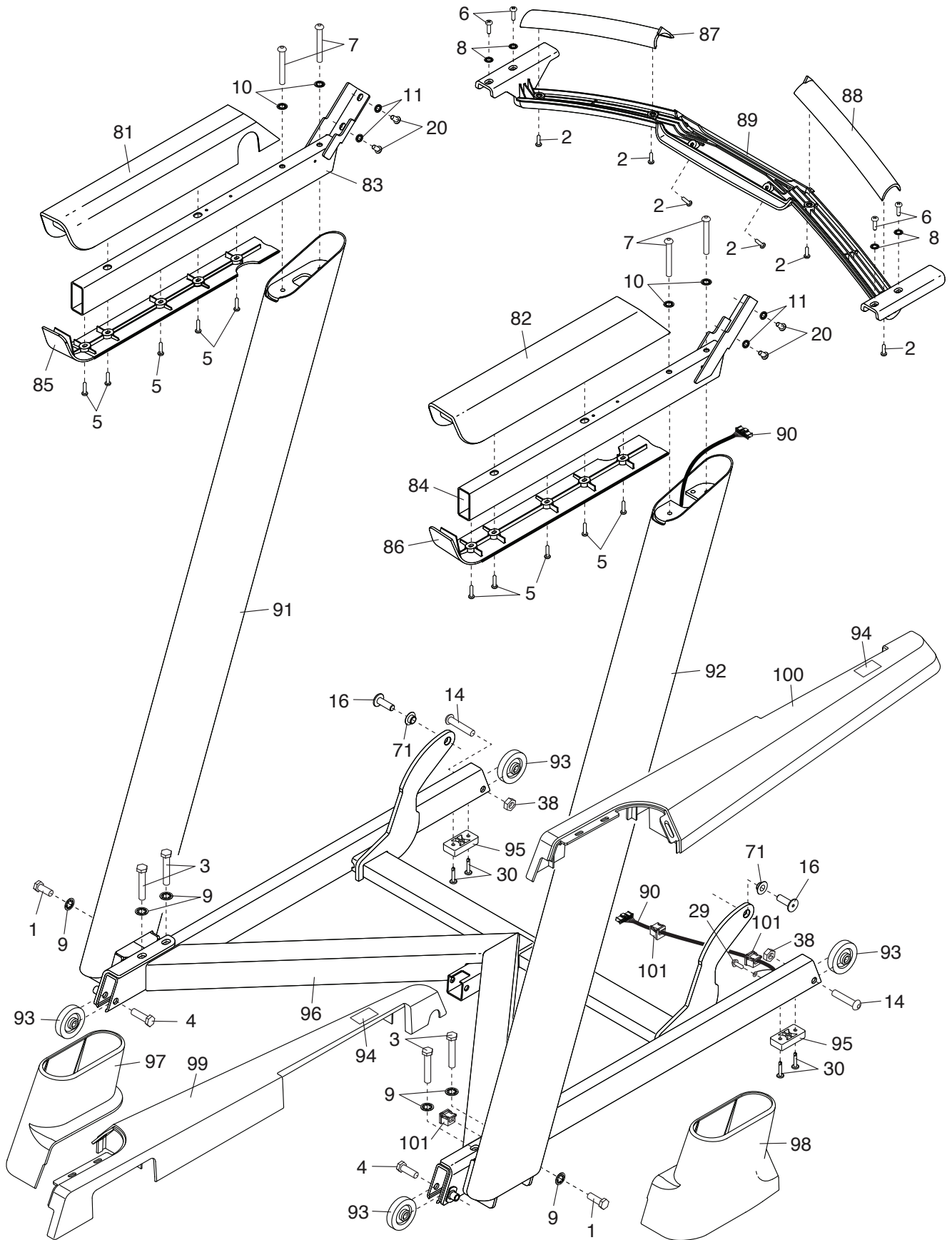

# EXPLODED DRAWING D

Model No. PFTL12820.0 R1220A

