

EXPLODED DRAWING A

Model No. PFTL12820.3 R0322A

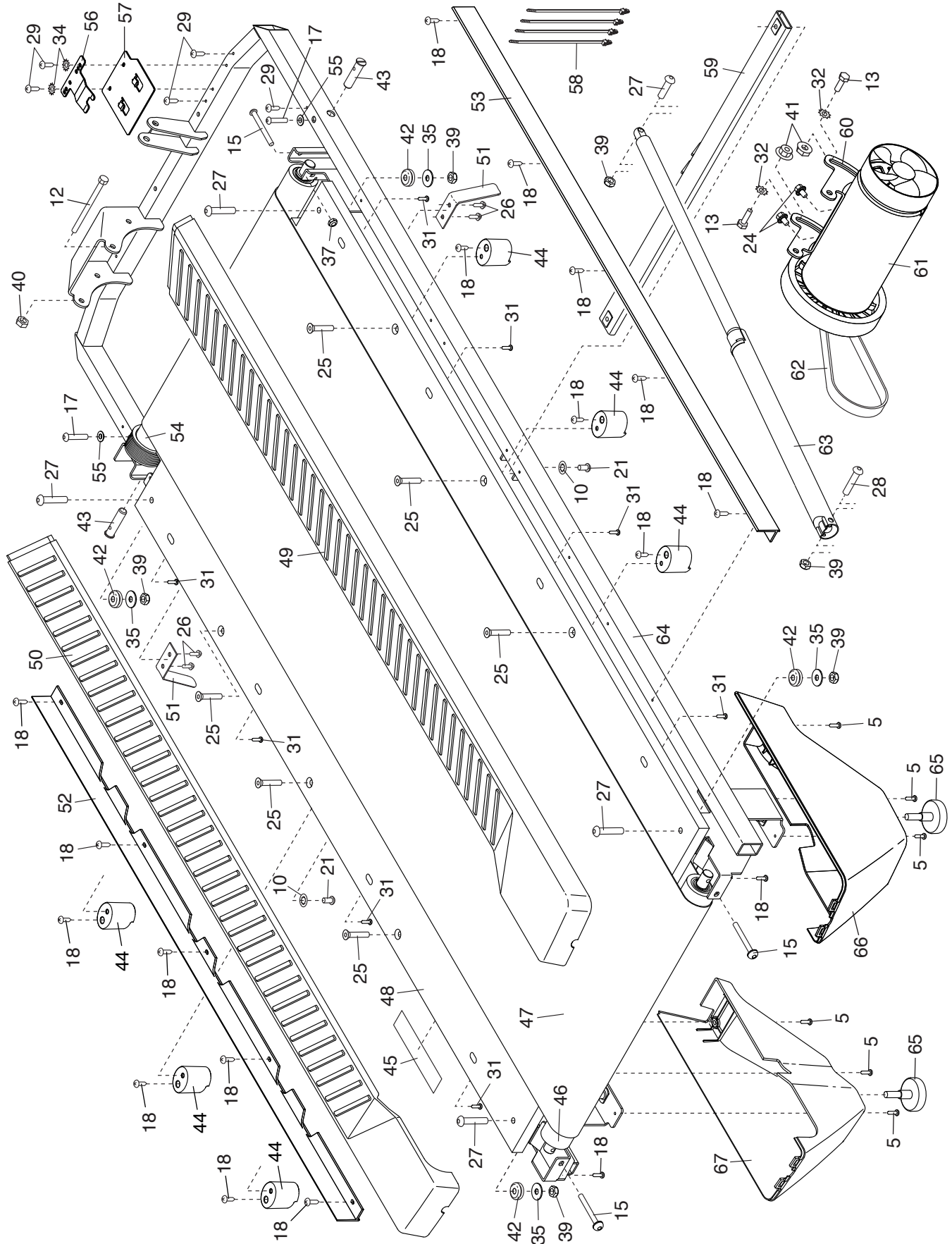

EXPLODED DRAWING B

Model No. PFTL12820.3 R0322A

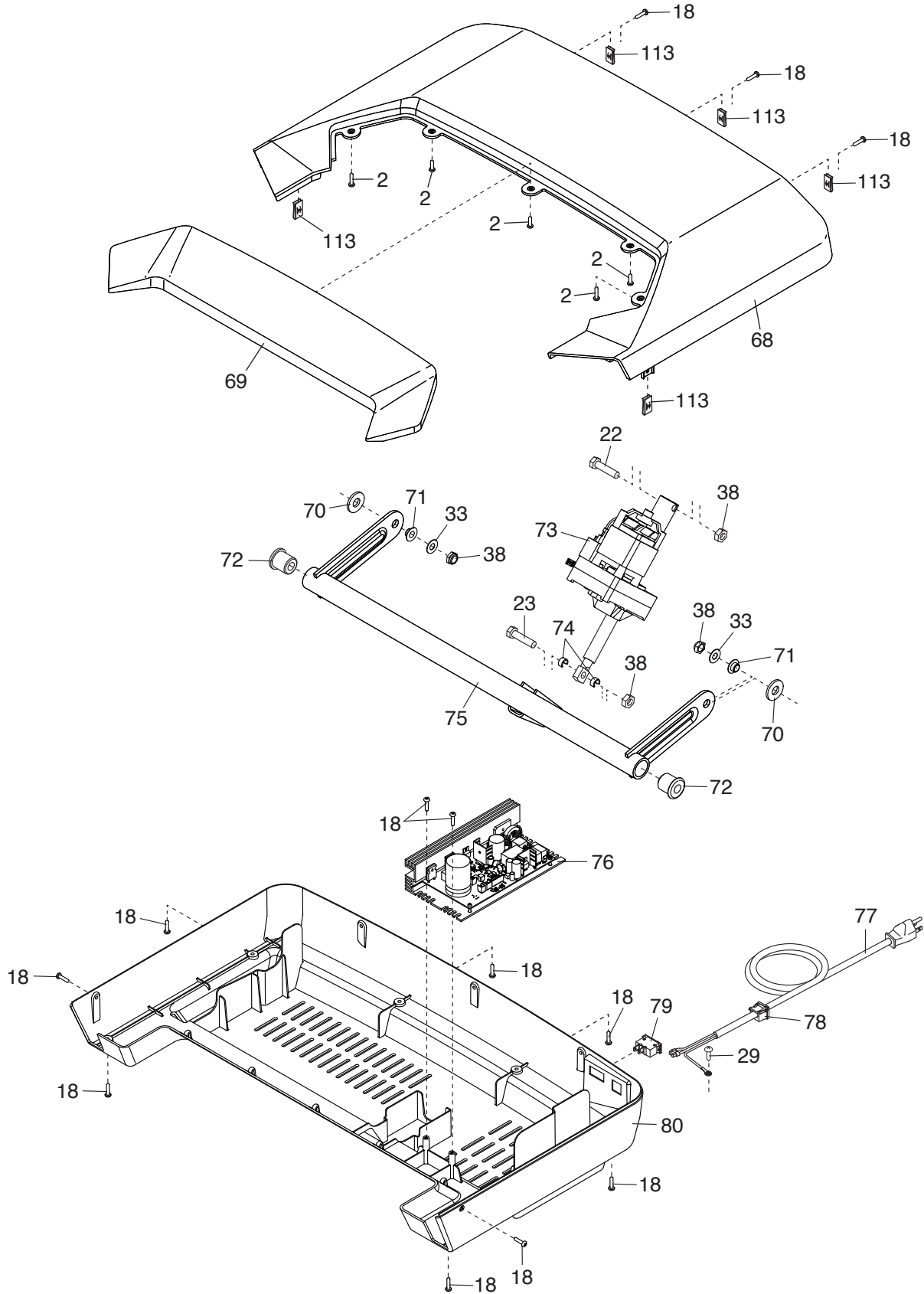

EXPLODED DRAWING C

Model No. PFTL12820.3 R0322A

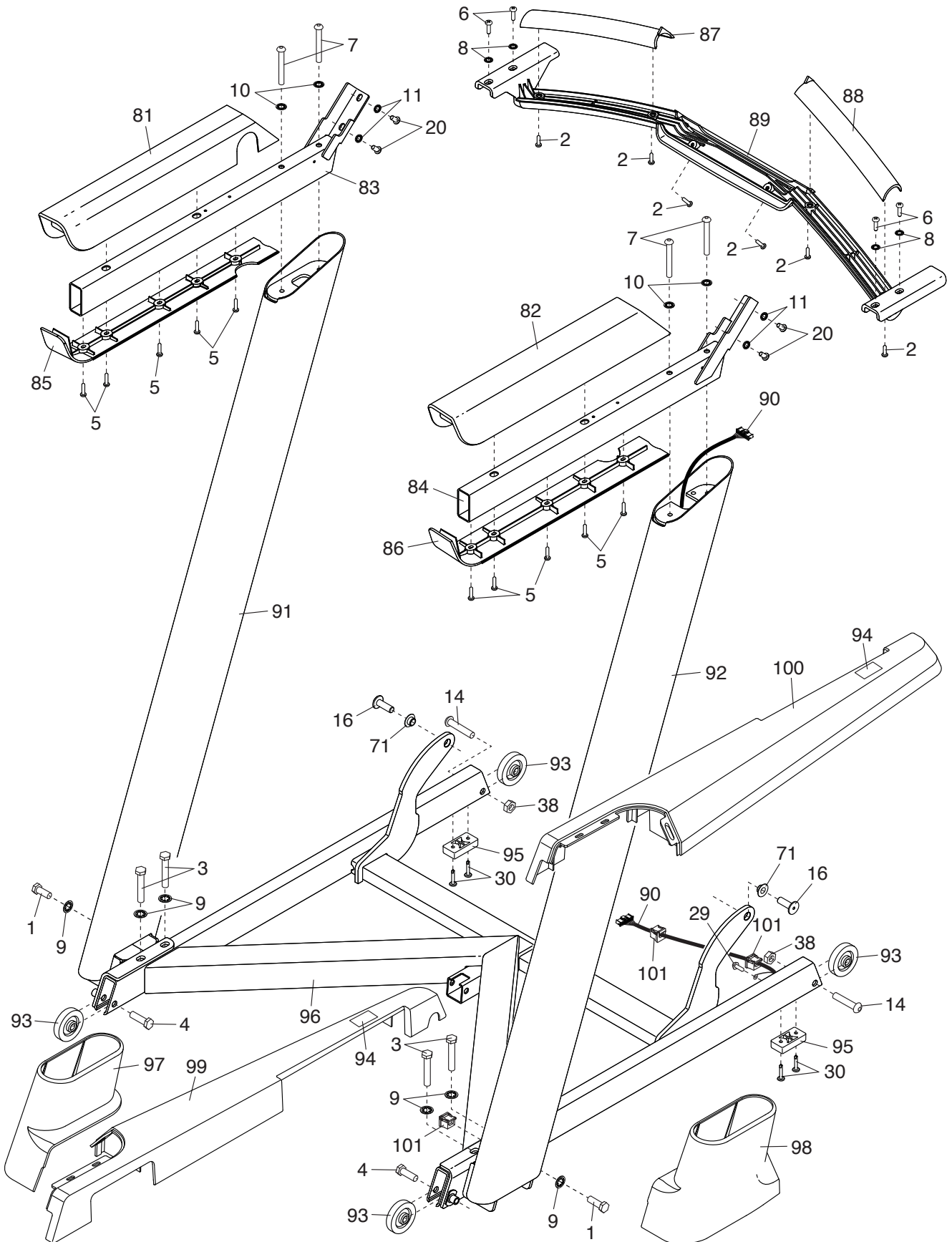

EXPLODED DRAWING D

Model No. PFTL12820.3 R0322A

