

EXPLODED DRAWING A

Model No. PFTL12820.7 R0723A

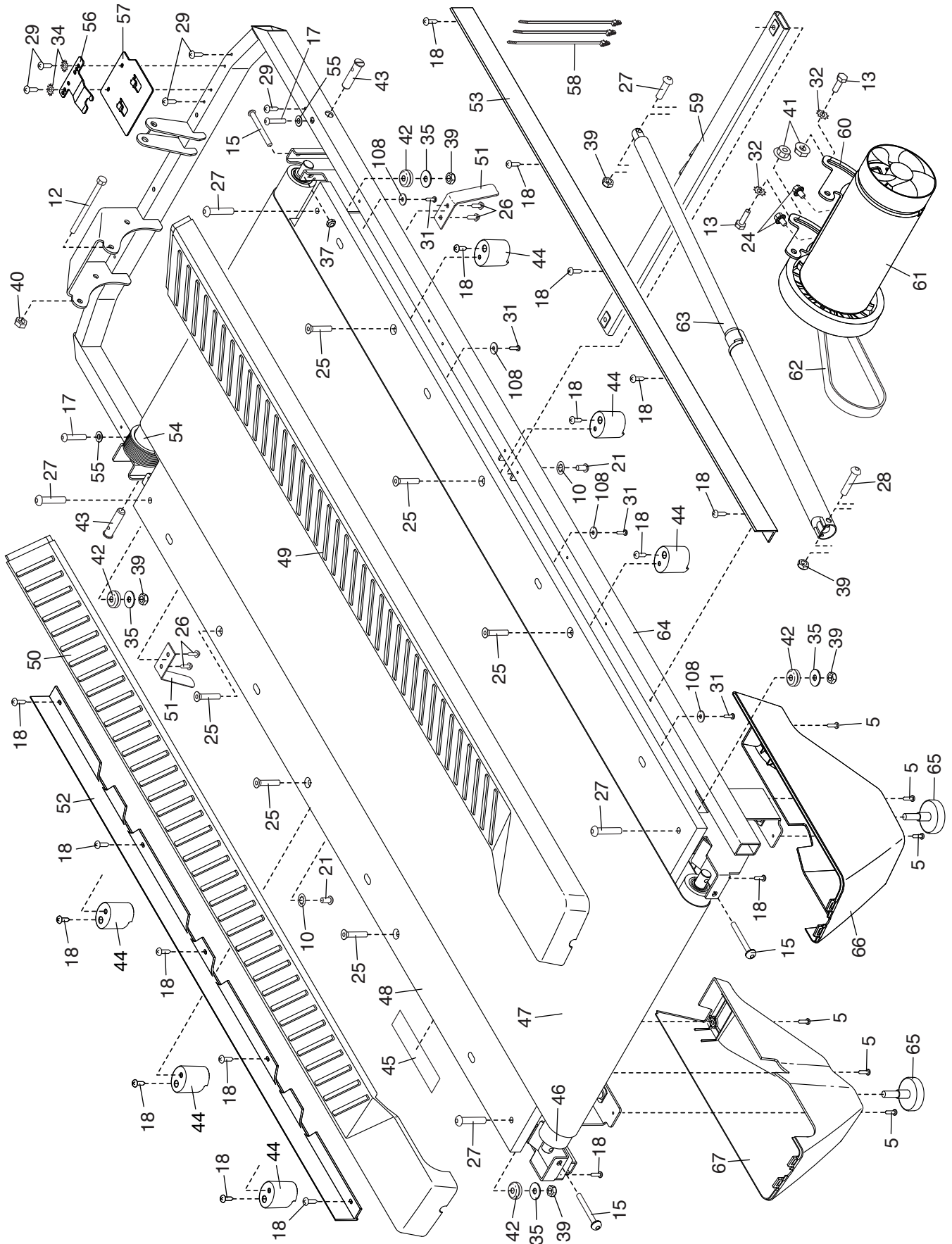

EXPLODED DRAWING B

Model No. PFTL12820.7 R0723A

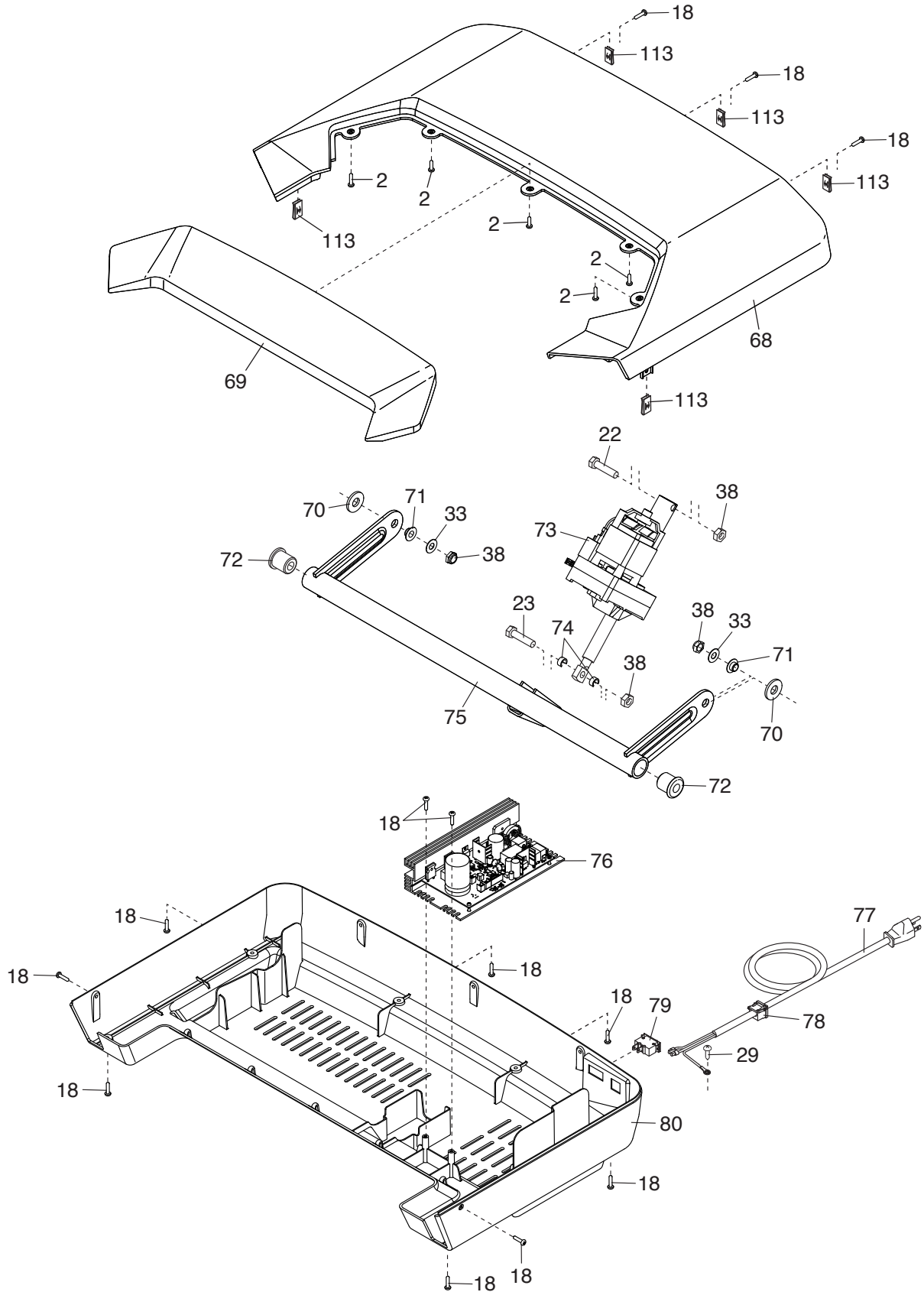

EXPLODED DRAWING C

Model No. PFTL12820.7 R0723A

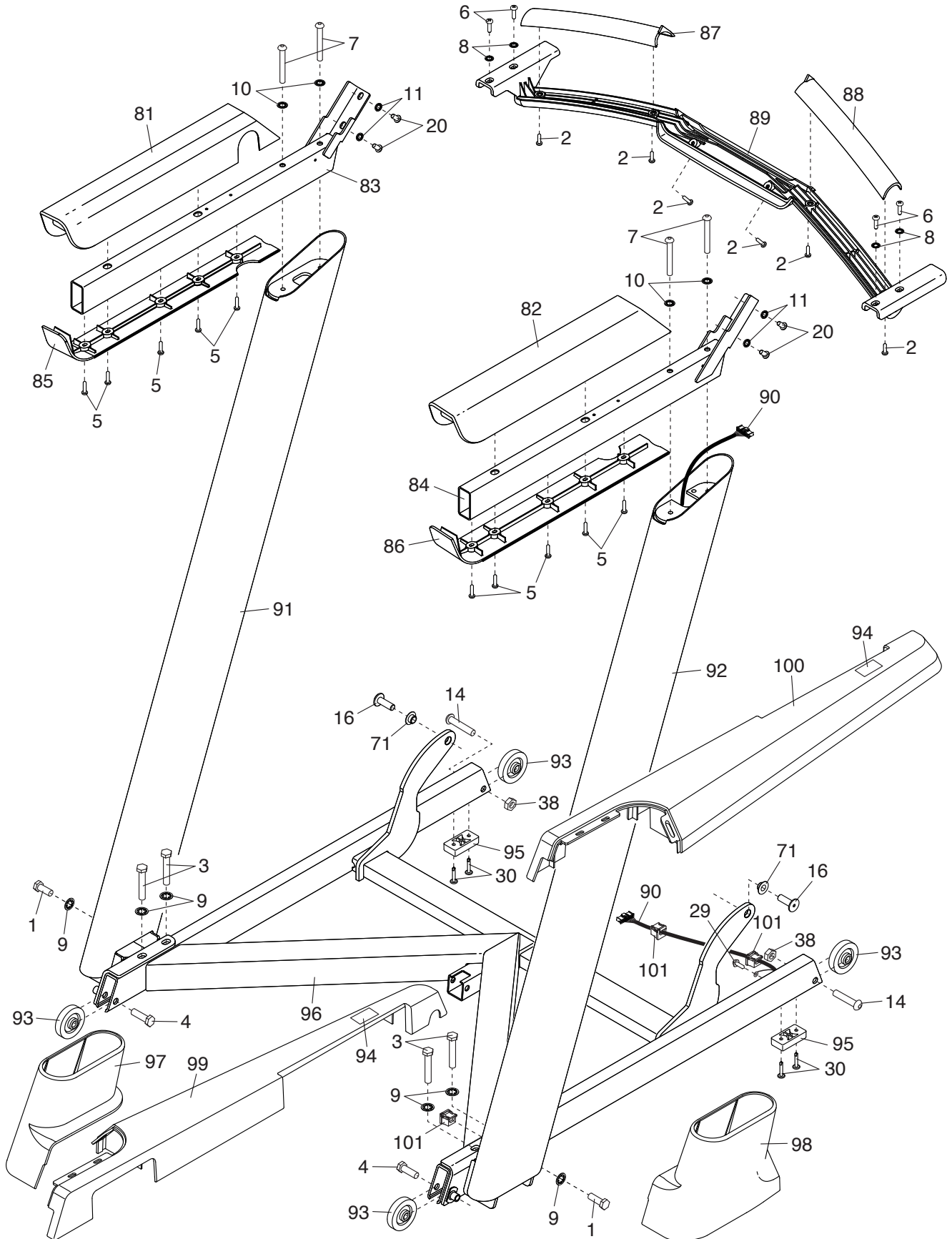

EXPLODED DRAWING D

Model No. PFTL12820.7 R0723A

