

EXPLODED DRAWING A

Model No. PFTL13113.1 R0714A

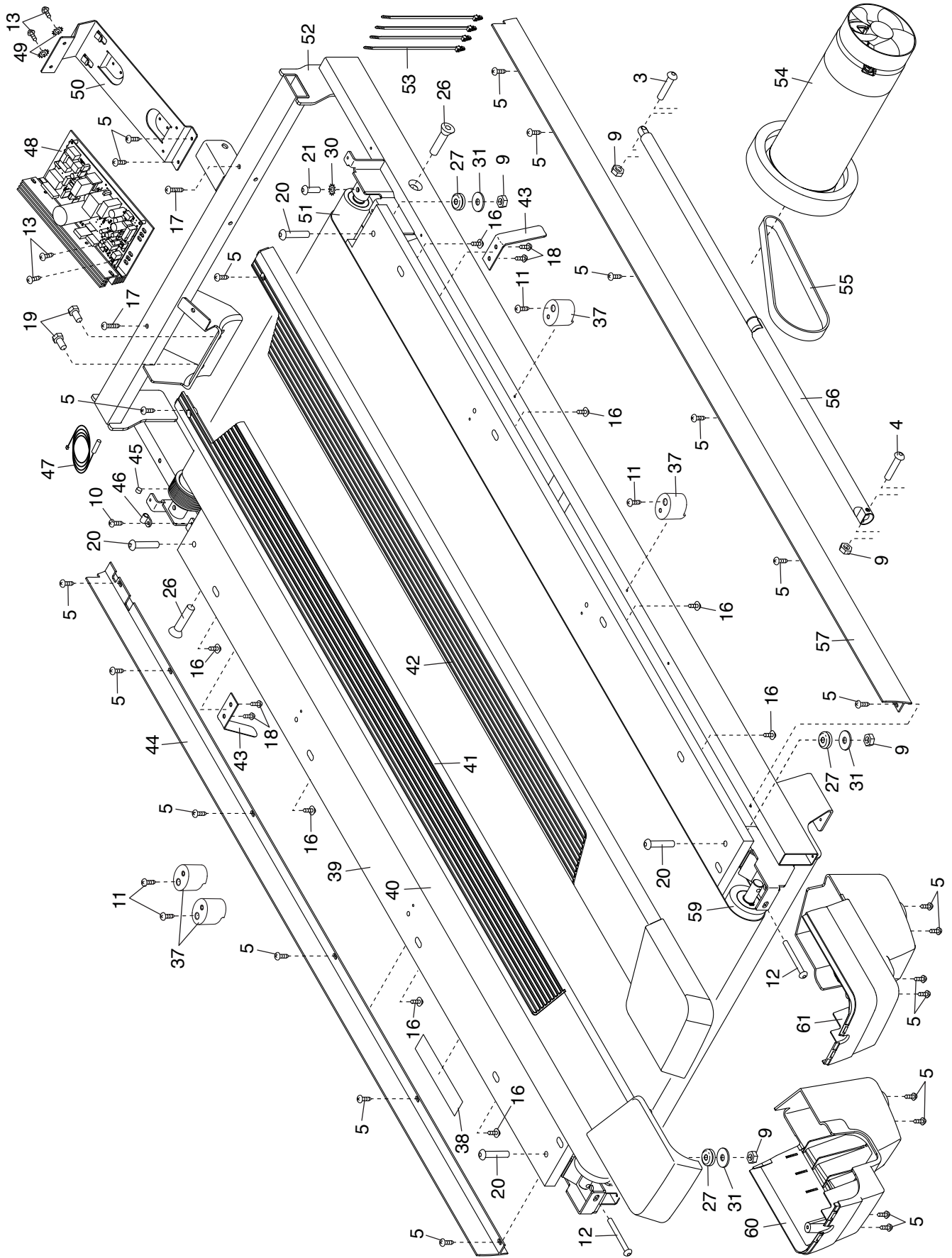

EXPLODED DRAWING B

Model No. PFTL13113.1 R0714A

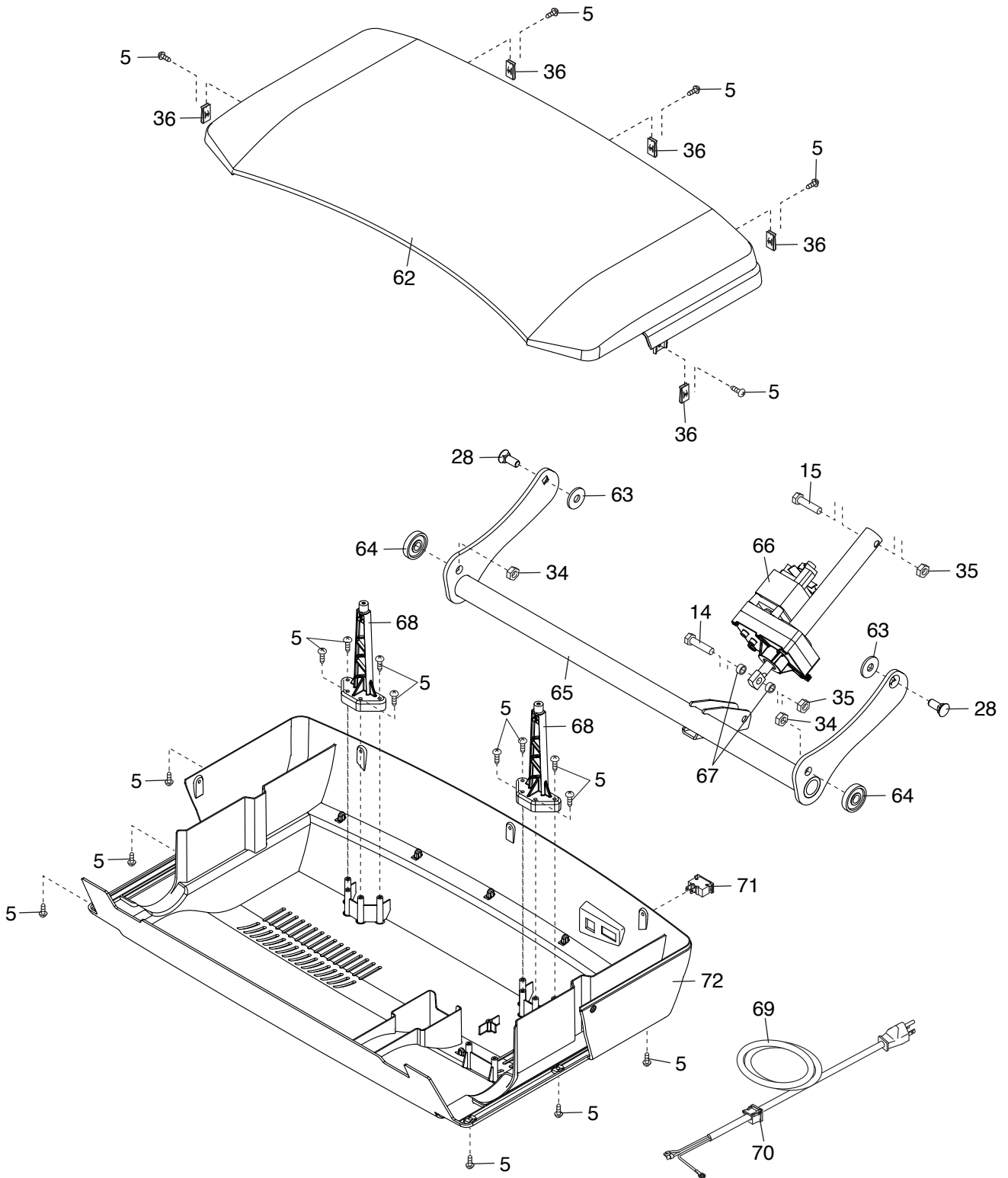

EXPLODED DRAWING C

Model No. PFTL13113.1 R0714A

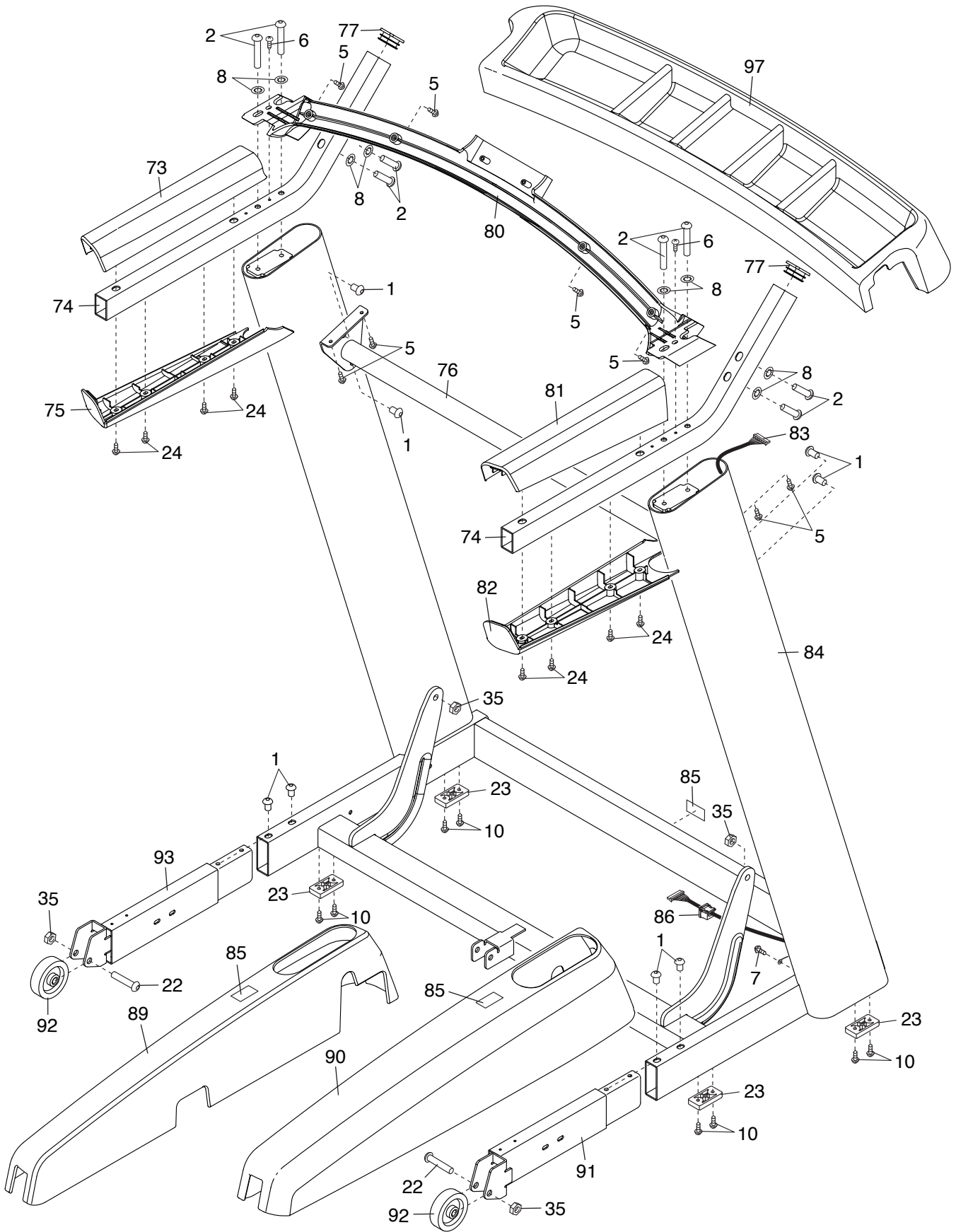

EXPLODED DRAWING D

Model No. PFTL13113.1 R0714A

