

# EXPLODED DRAWING A

Model No. PFTL13113.4 R0515A

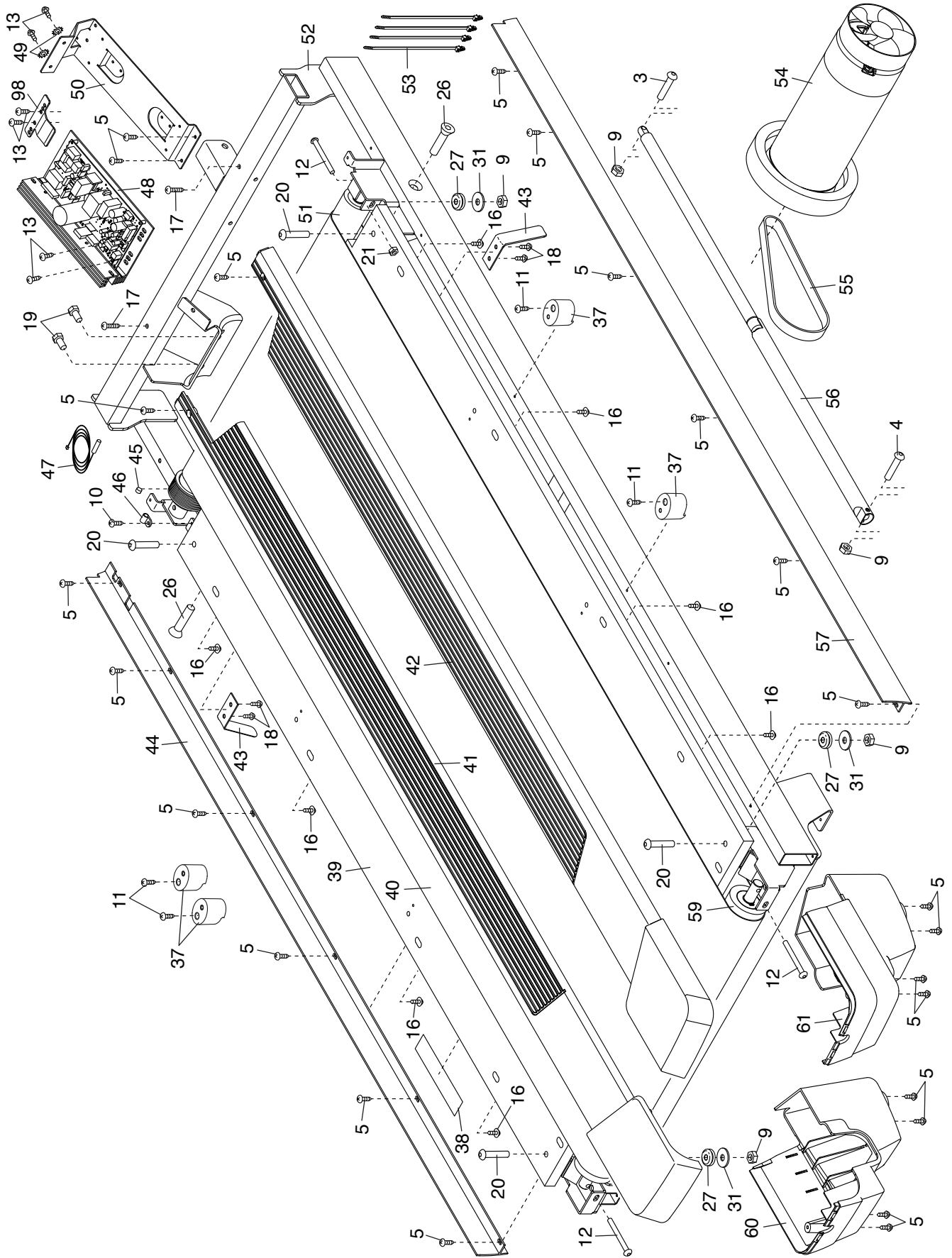

# EXPLODED DRAWING B

Model No. PFTL13113.4 R0515A

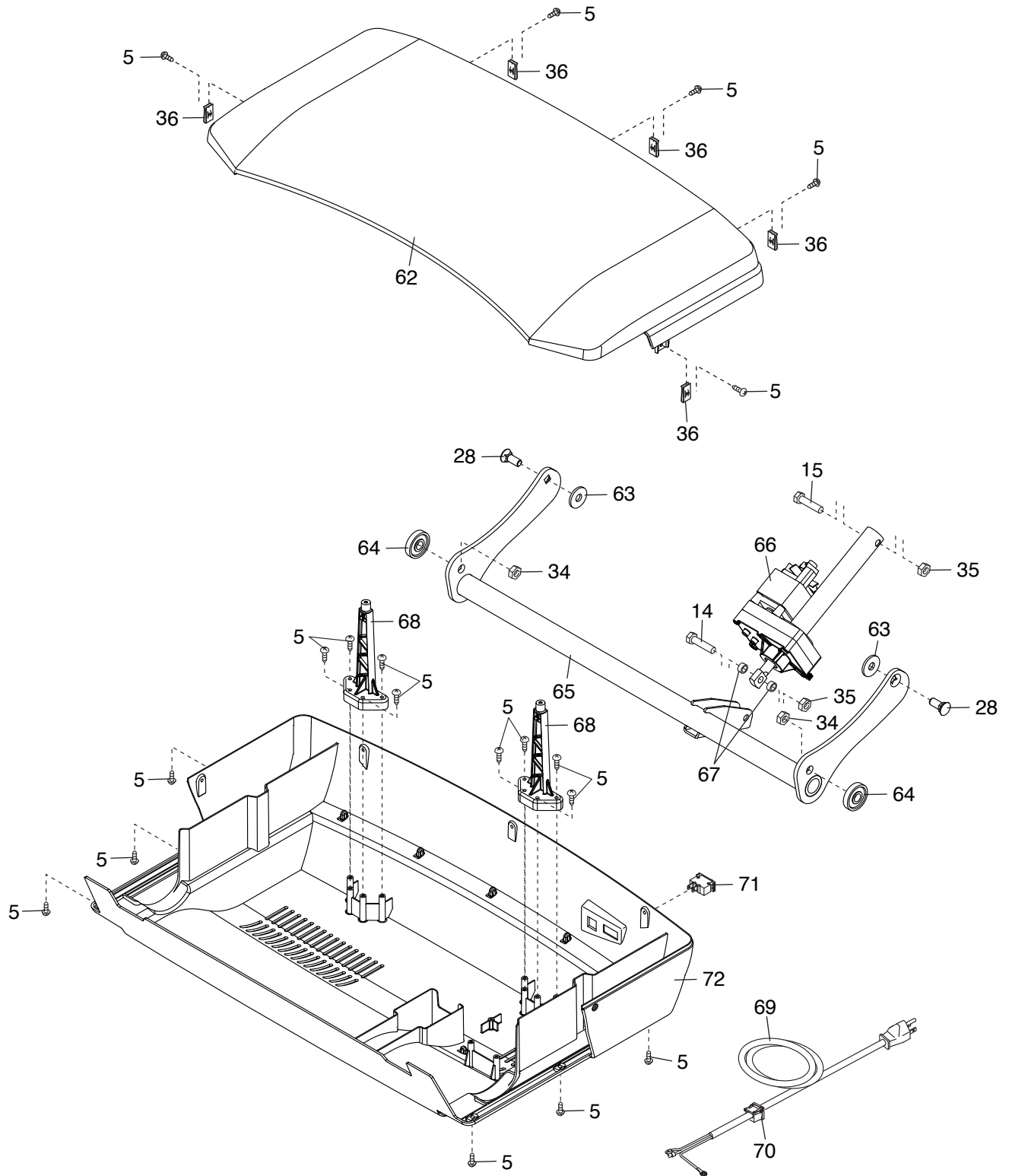

# EXPLODED DRAWING C

Model No. PFTL13113.4 R0515A

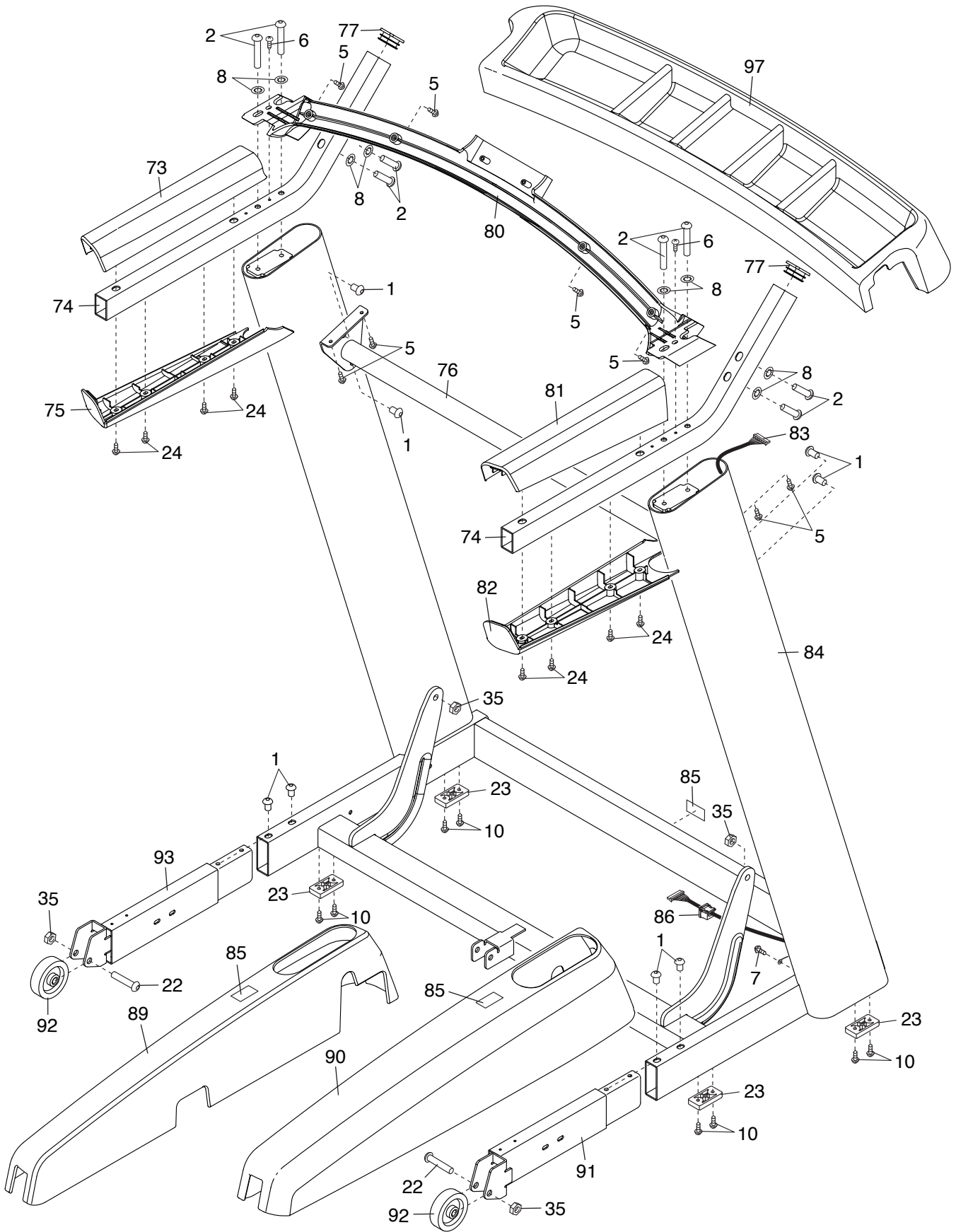

# EXPLODED DRAWING D

Model No. PFTL13113.4 R0515A

