

# EXPLODED DRAWING A

Model No. PFTL13113.5 R1015A

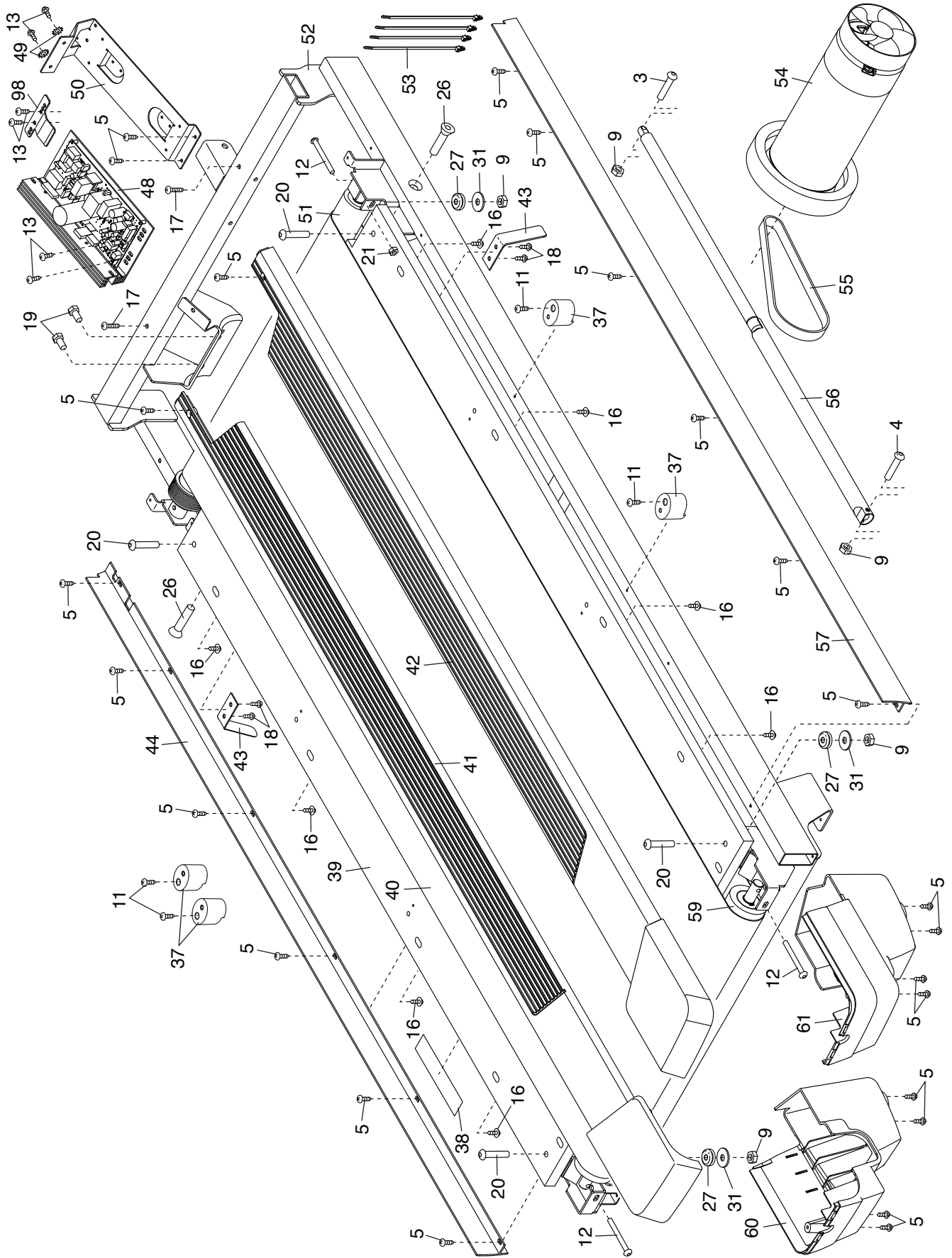

# EXPLODED DRAWING B

Model No. PFTL13113.5 R1015A

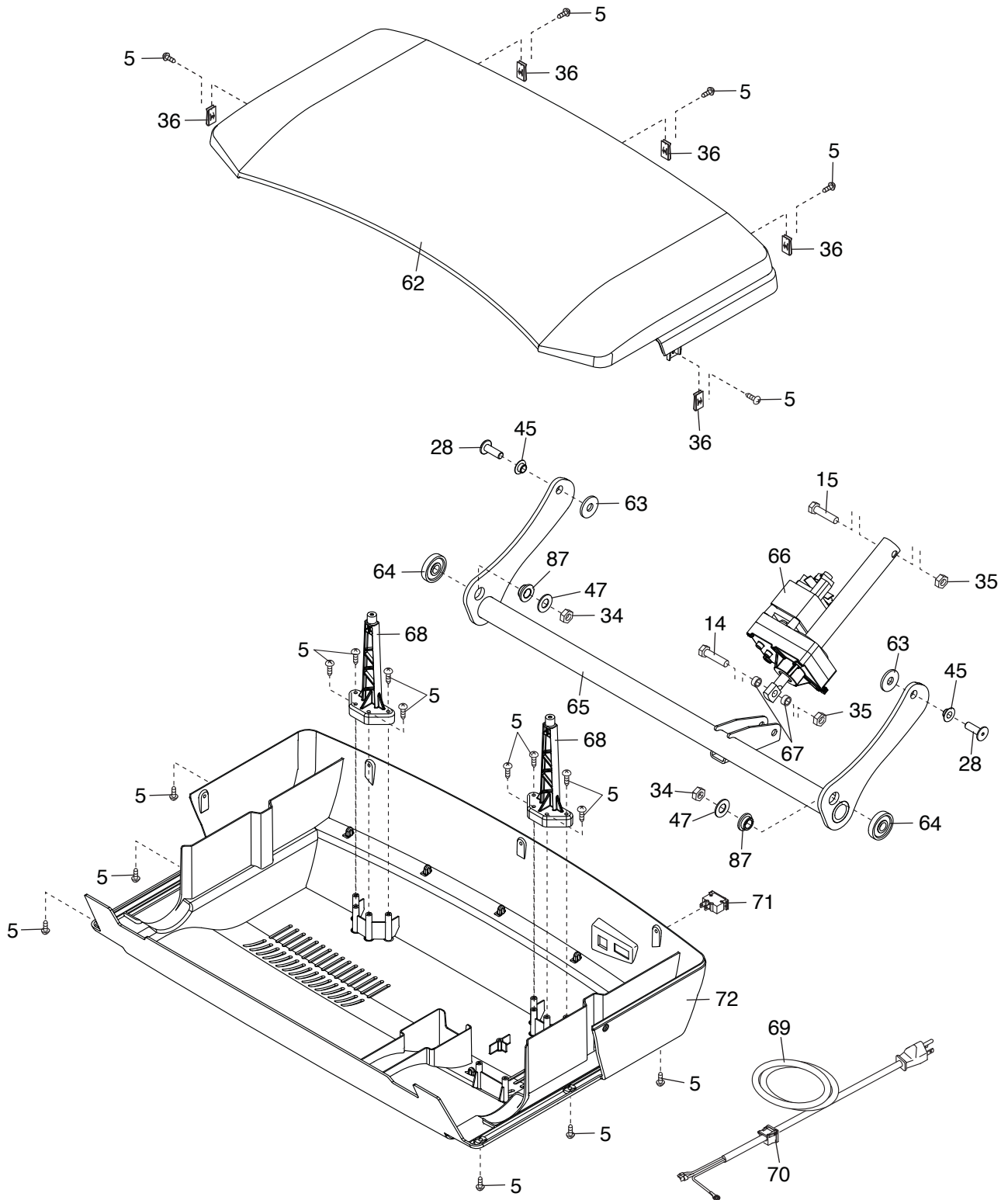

# EXPLODED DRAWING C

Model No. PFTL13113.5 R1015A

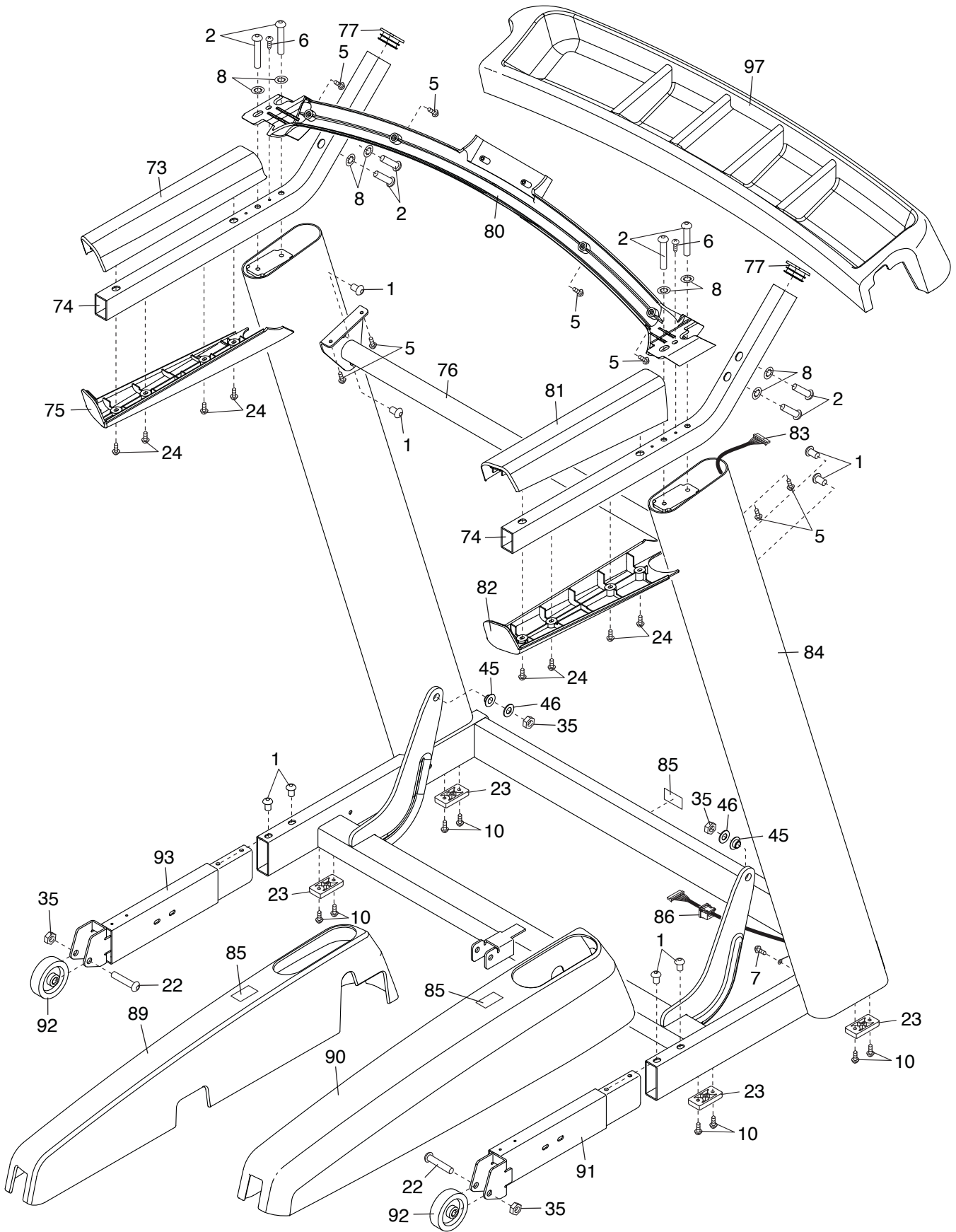

# EXPLODED DRAWING D

Model No. PFTL13113.5 R1015A

