

EXPLODED DRAWING A

Model No. PFTL13113.6 R1015A

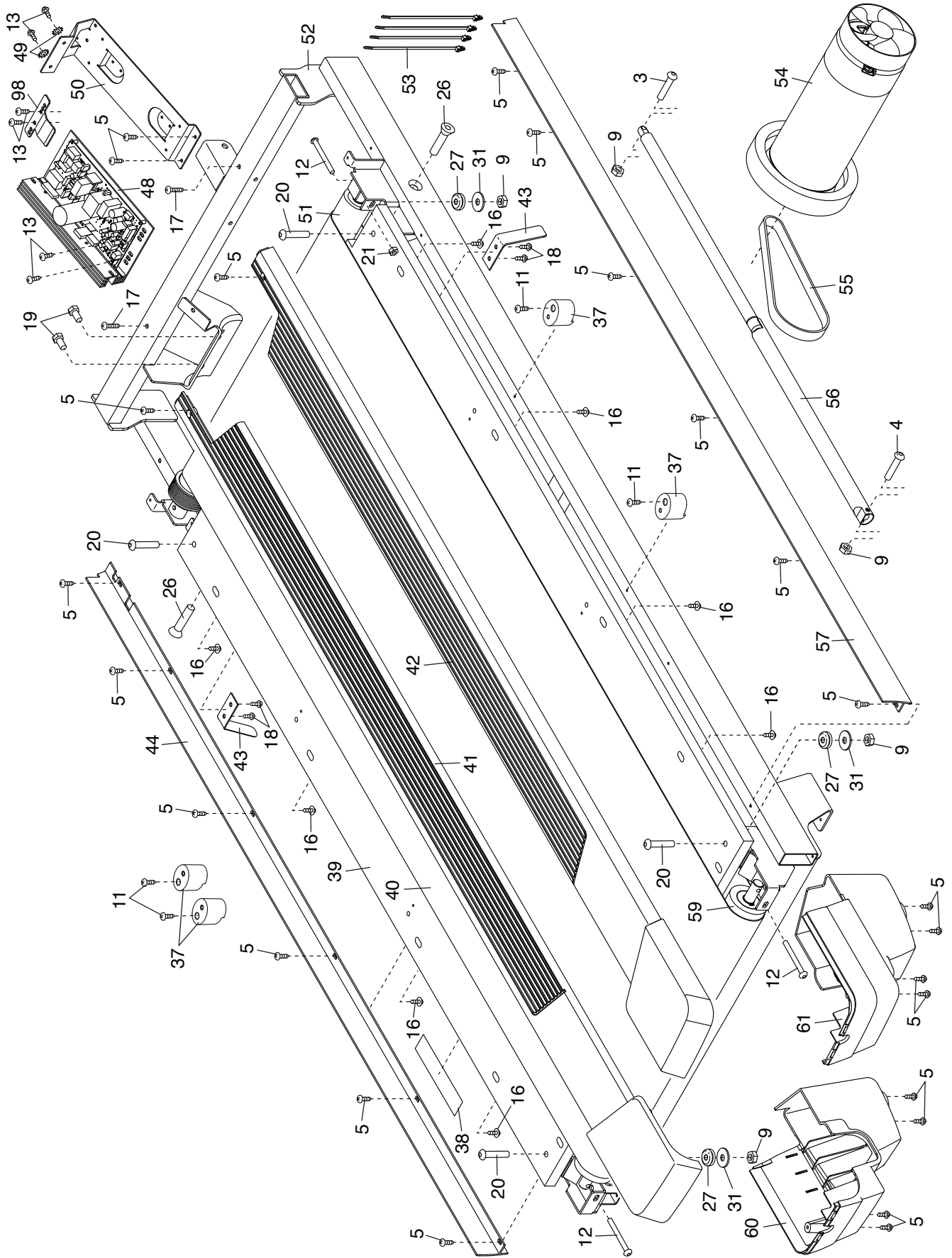

EXPLODED DRAWING B

Model No. PFTL13113.6 R1015A

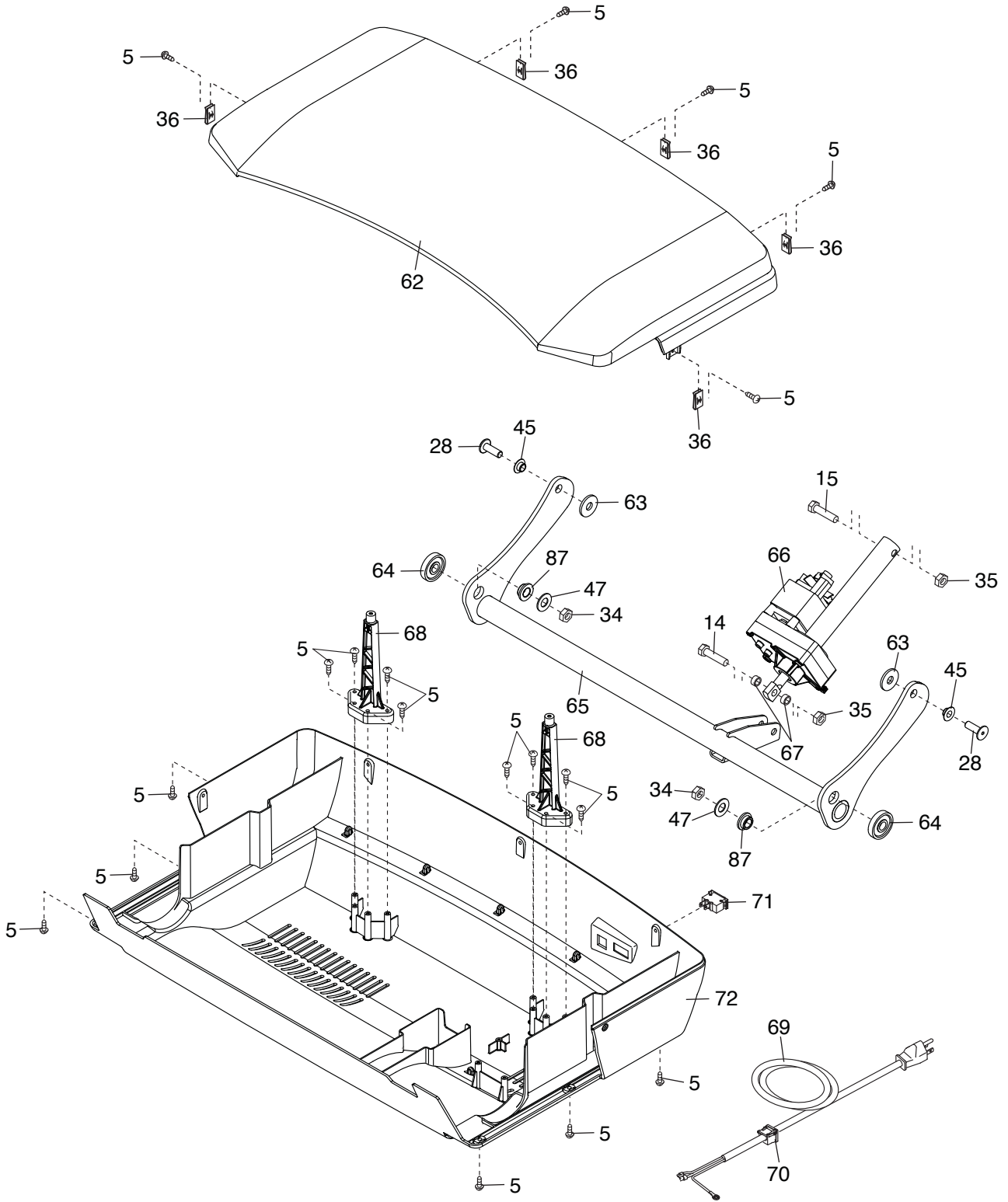

EXPLODED DRAWING C

Model No. PFTL13113.6 R1015A

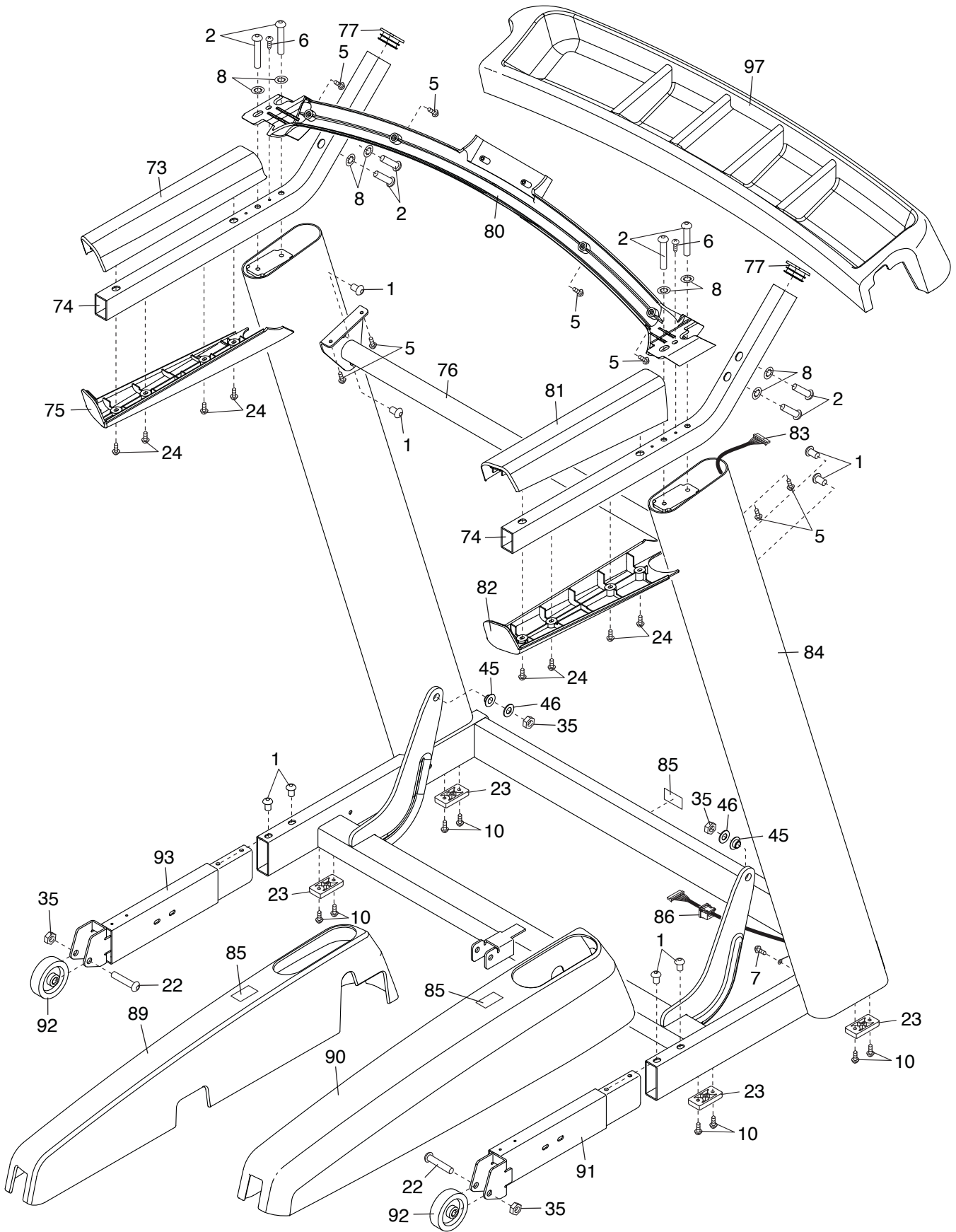

EXPLODED DRAWING D

Model No. PFTL13113.6 R1015A

