

EXPLODED DRAWING A

Model No. PFTL13113.7 R0616A

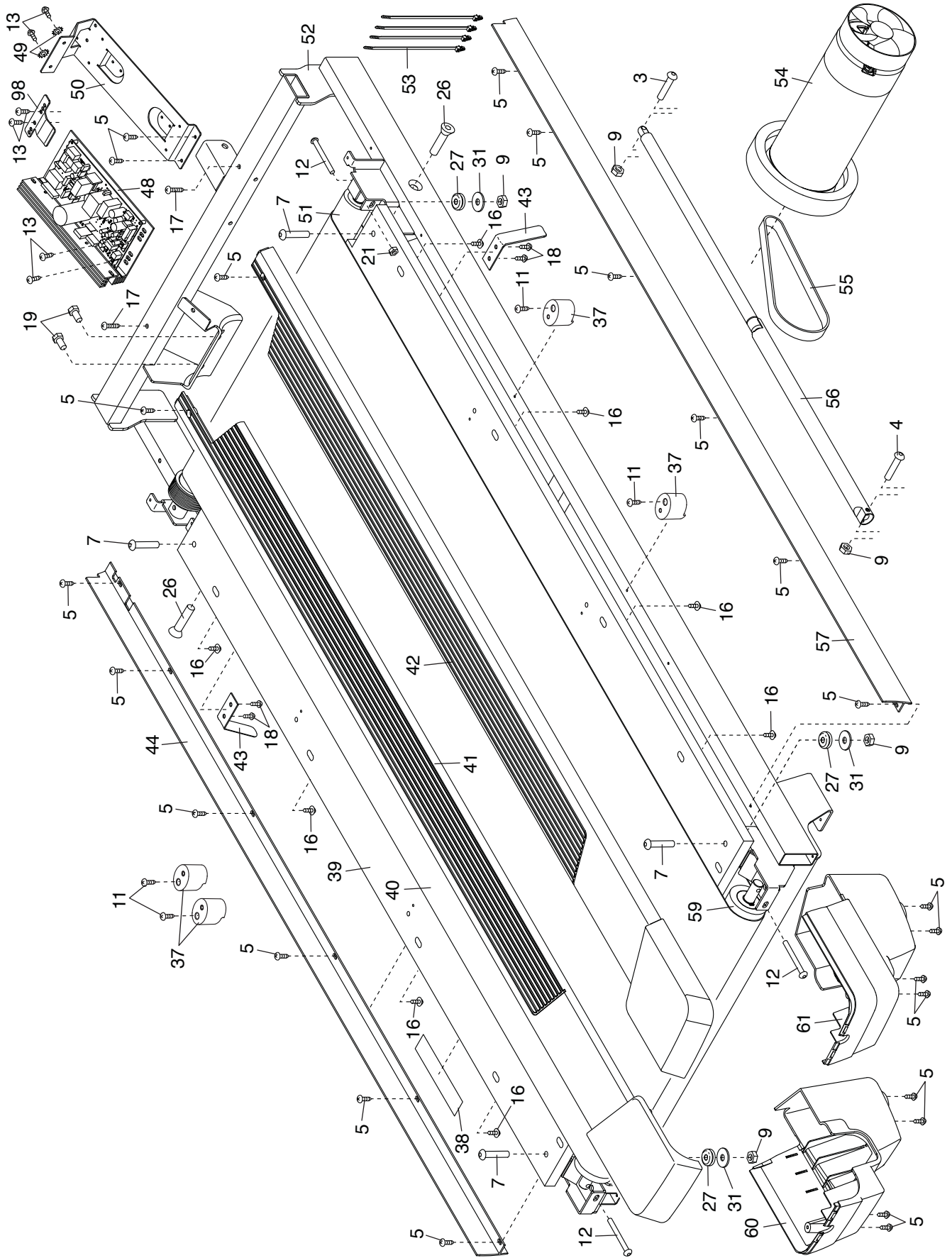

36

EXPLODED DRAWING B

Model No. PFTL13113.7 R0616A

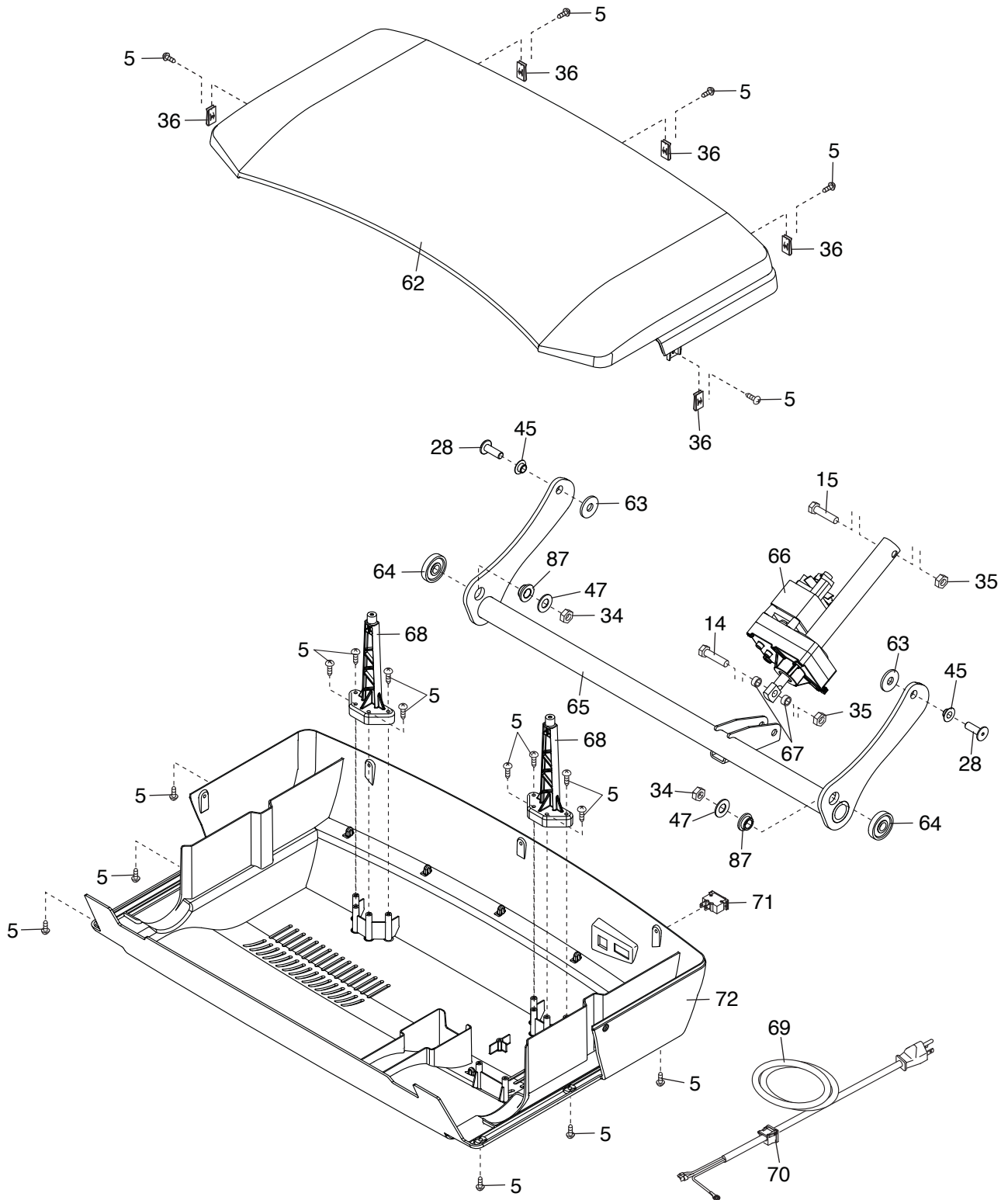

EXPLODED DRAWING C

Model No. PFTL13113.7 R0616A

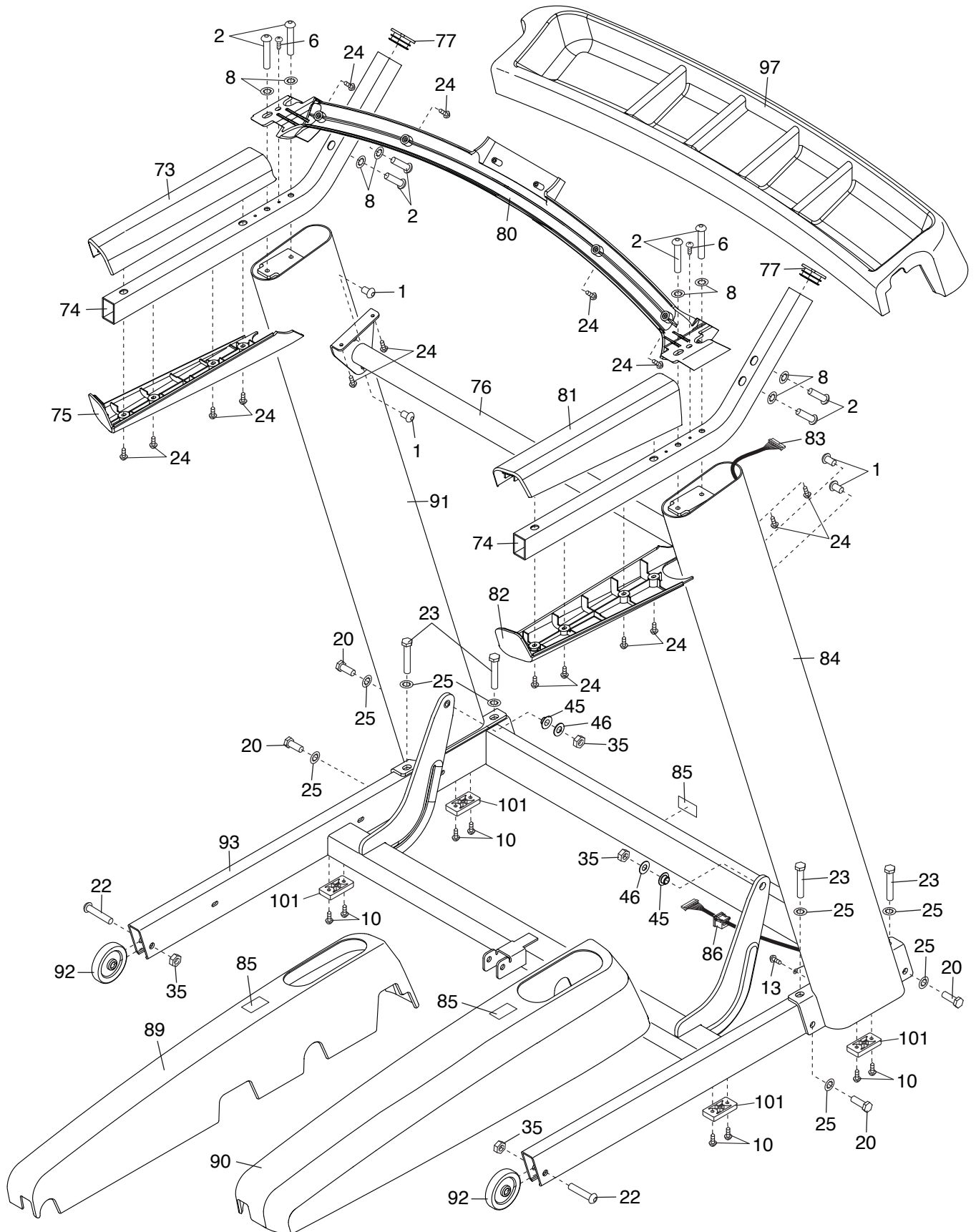

EXPLODED DRAWING D

Model No. PFTL13113.7 R0616A

