

EXPLODED DRAWING A

Model No. PFTL13118.1 R0918A

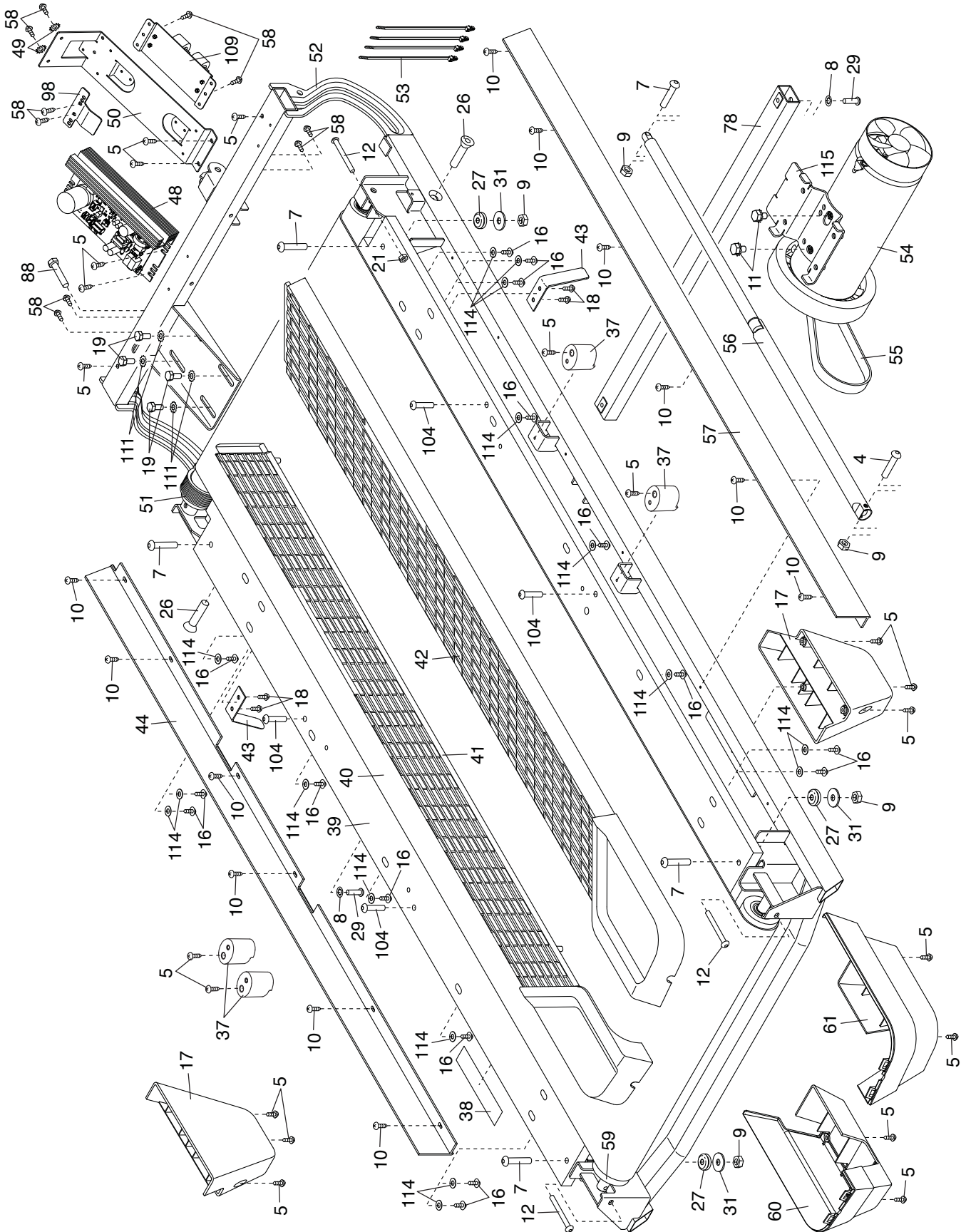

EXPLODED DRAWING B

Model No. PFTL13118.1 R0918A

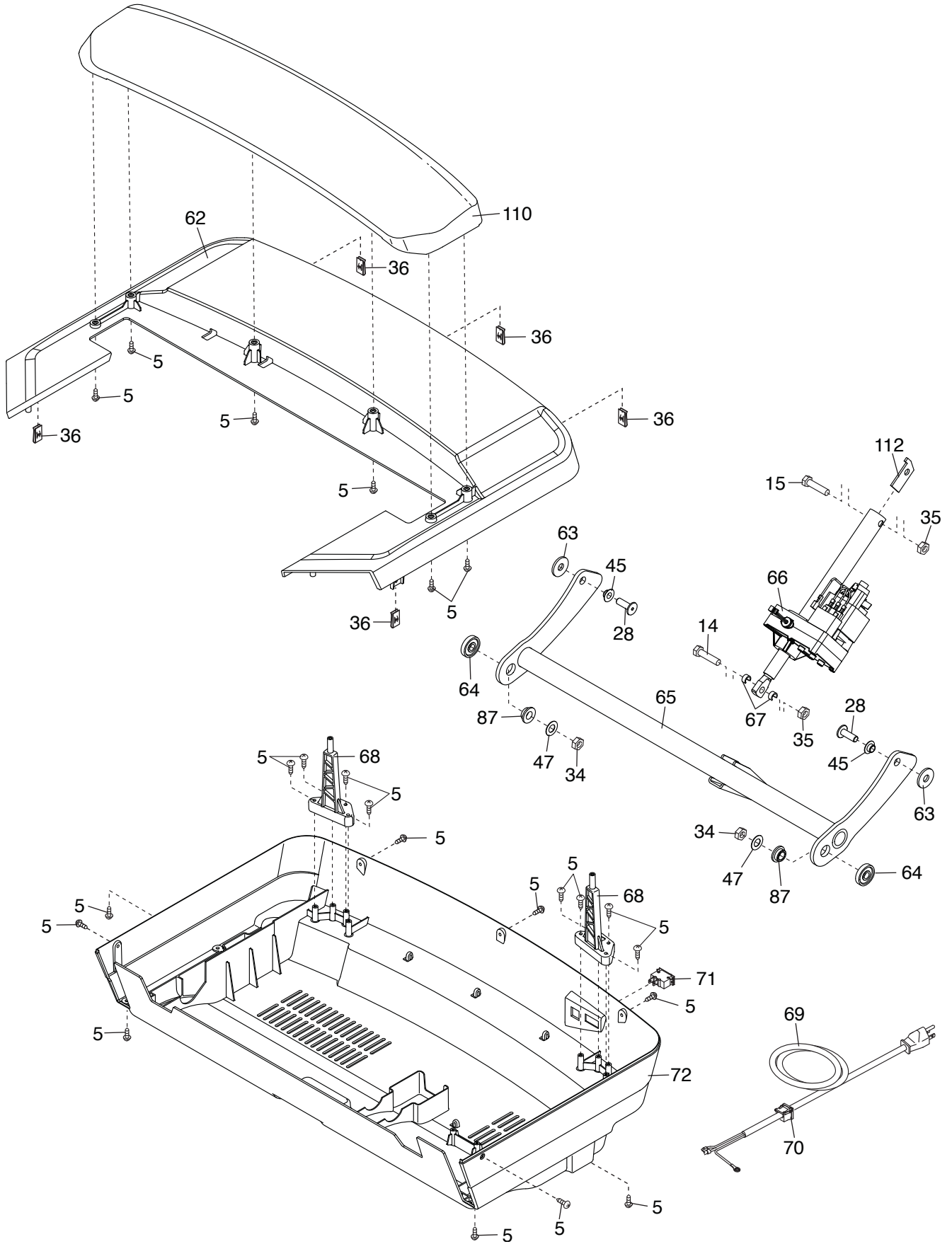

EXPLODED DRAWING C

Model No. PFTL13118.1 R0918A

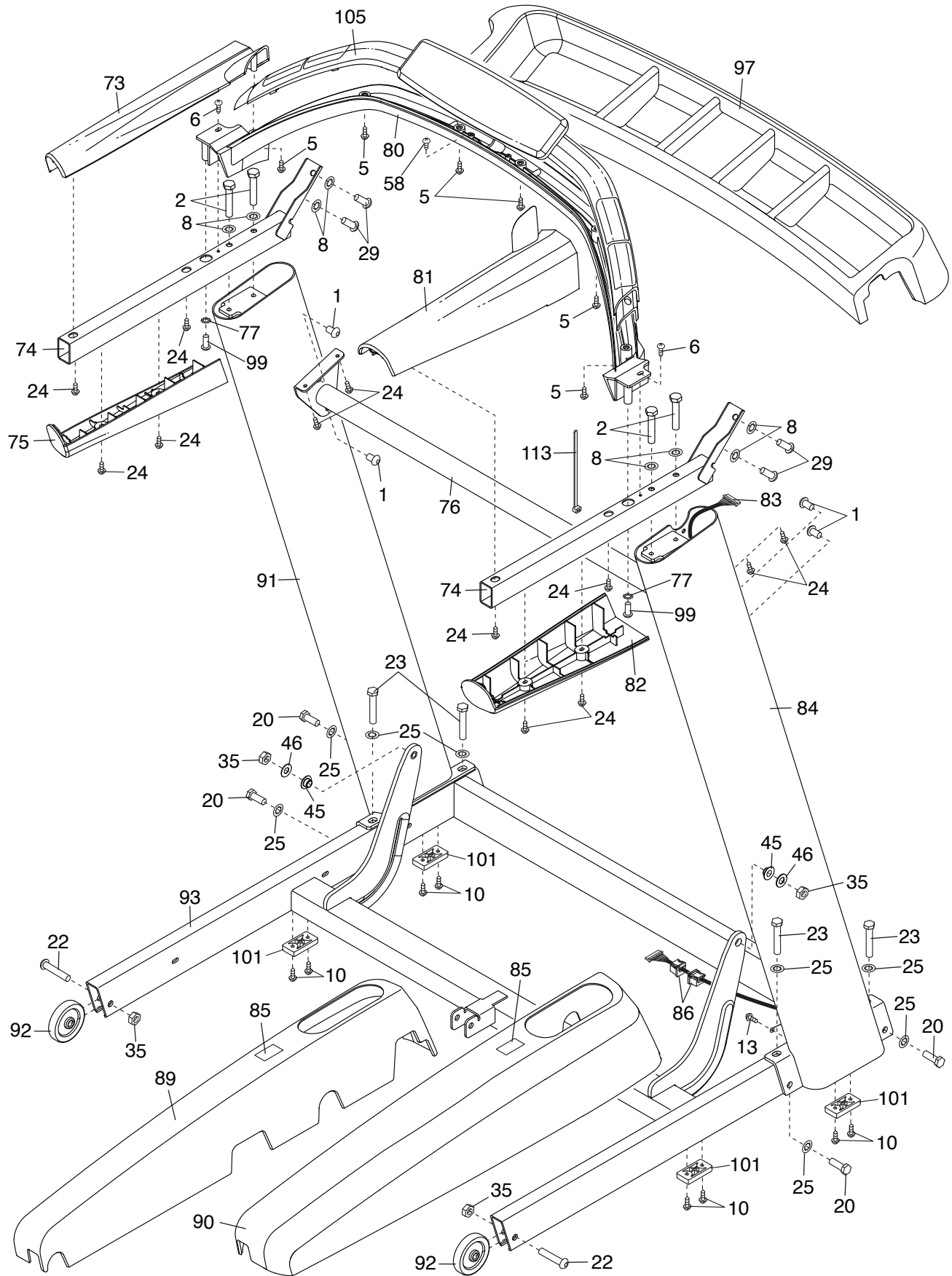

EXPLODED DRAWING D

Model No. PFTL13118.1 R0918A

