

EXPLODED DRAWING A

Model No. PFTL13118.5 R0920A

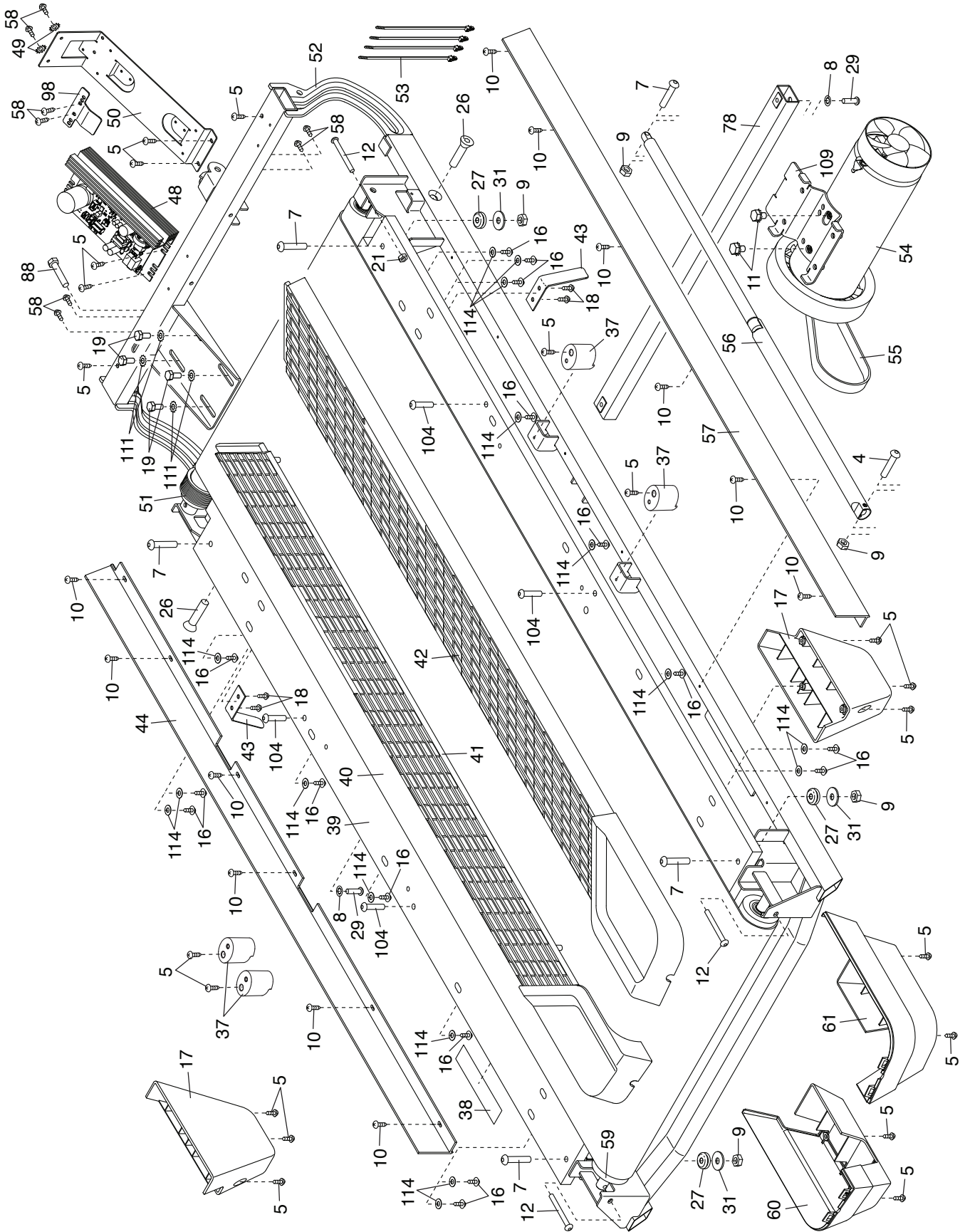

EXPLODED DRAWING B

Model No. PFTL13118.5 R0920A

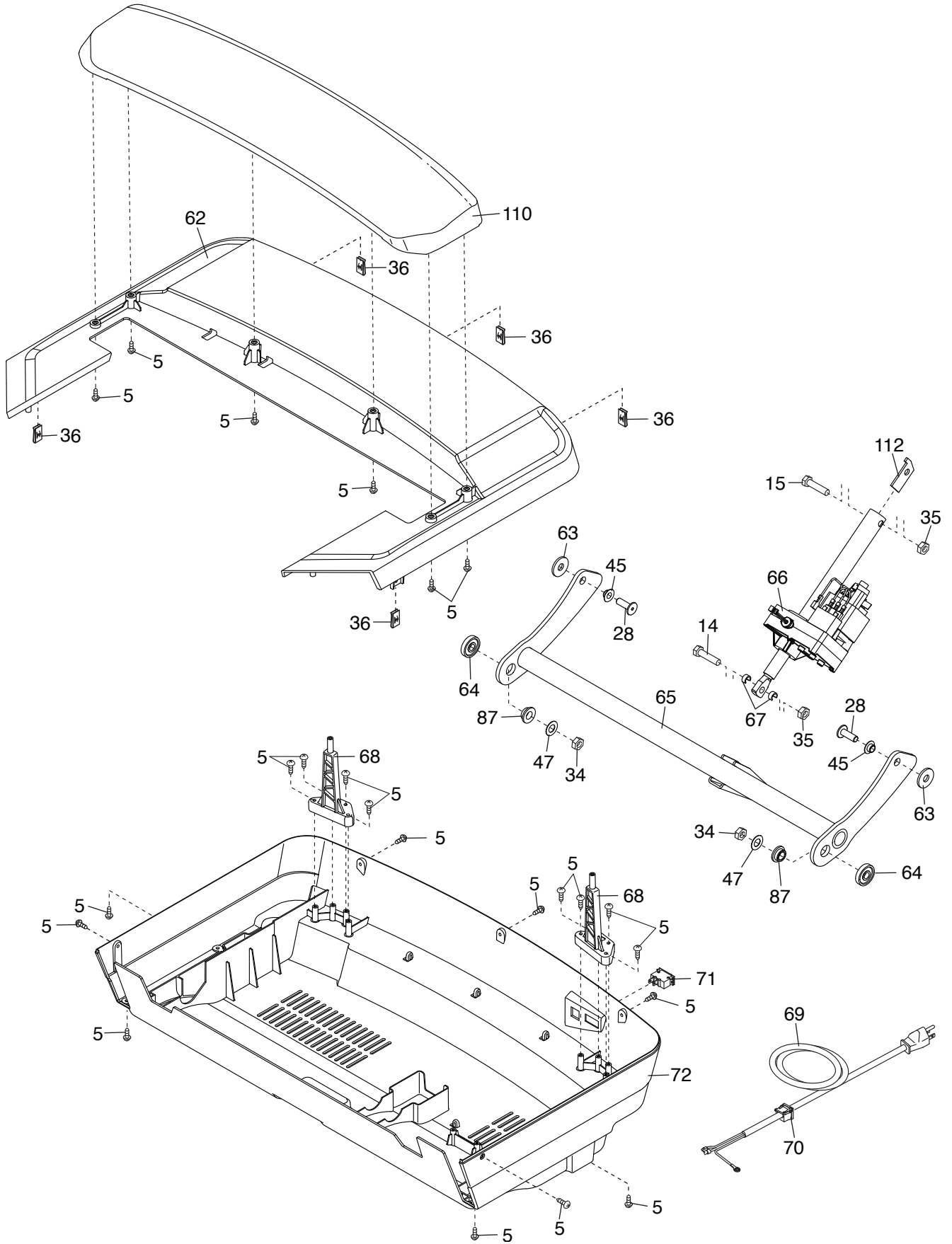

EXPLODED DRAWING C

Model No. PFTL13118.5 R0920A

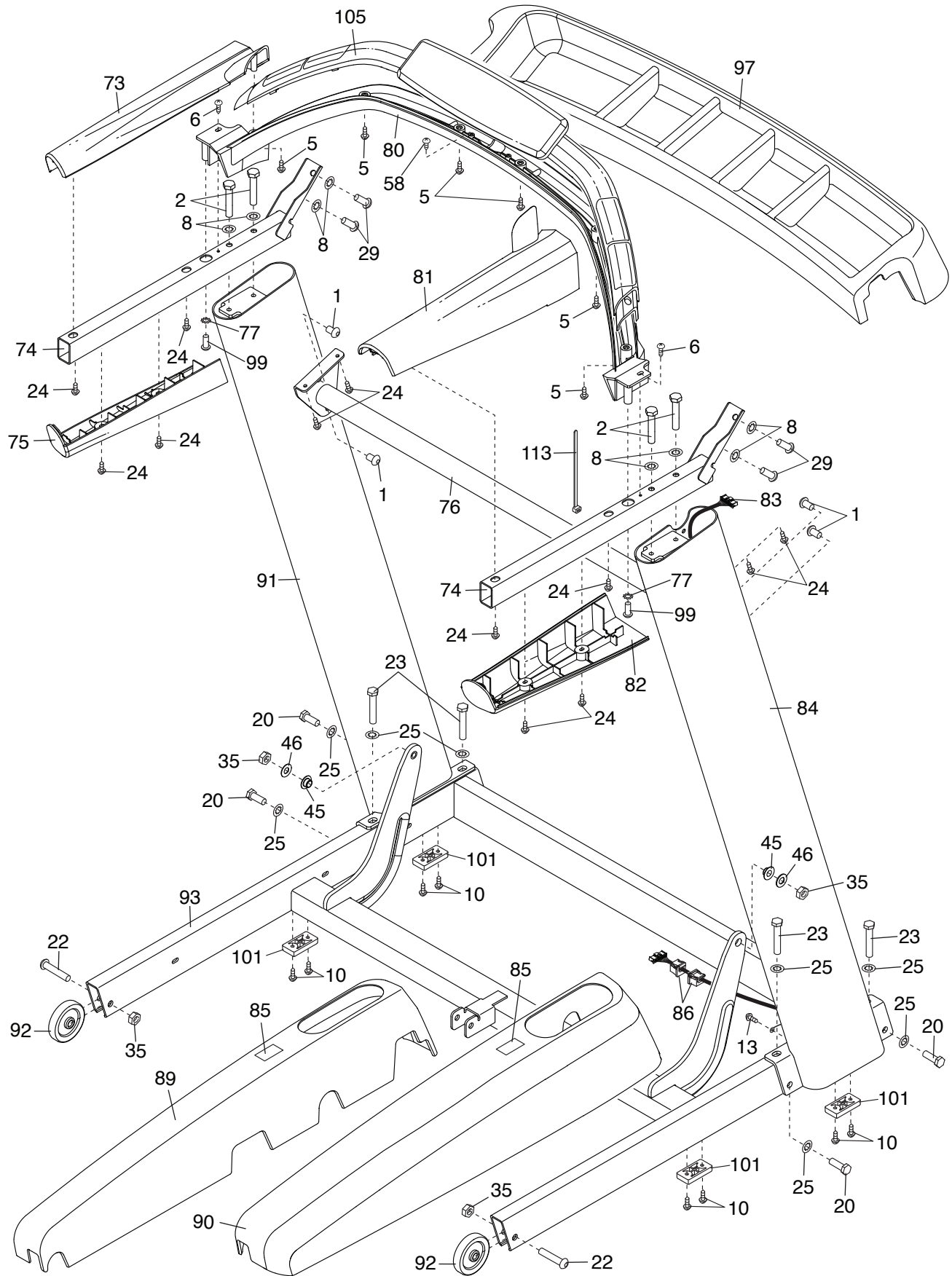

EXPLODED DRAWING D

Model No. PFTL13118.5 R0920A

