

EXPLODED DRAWING A

Model No. PFTL14011.2 R1213A

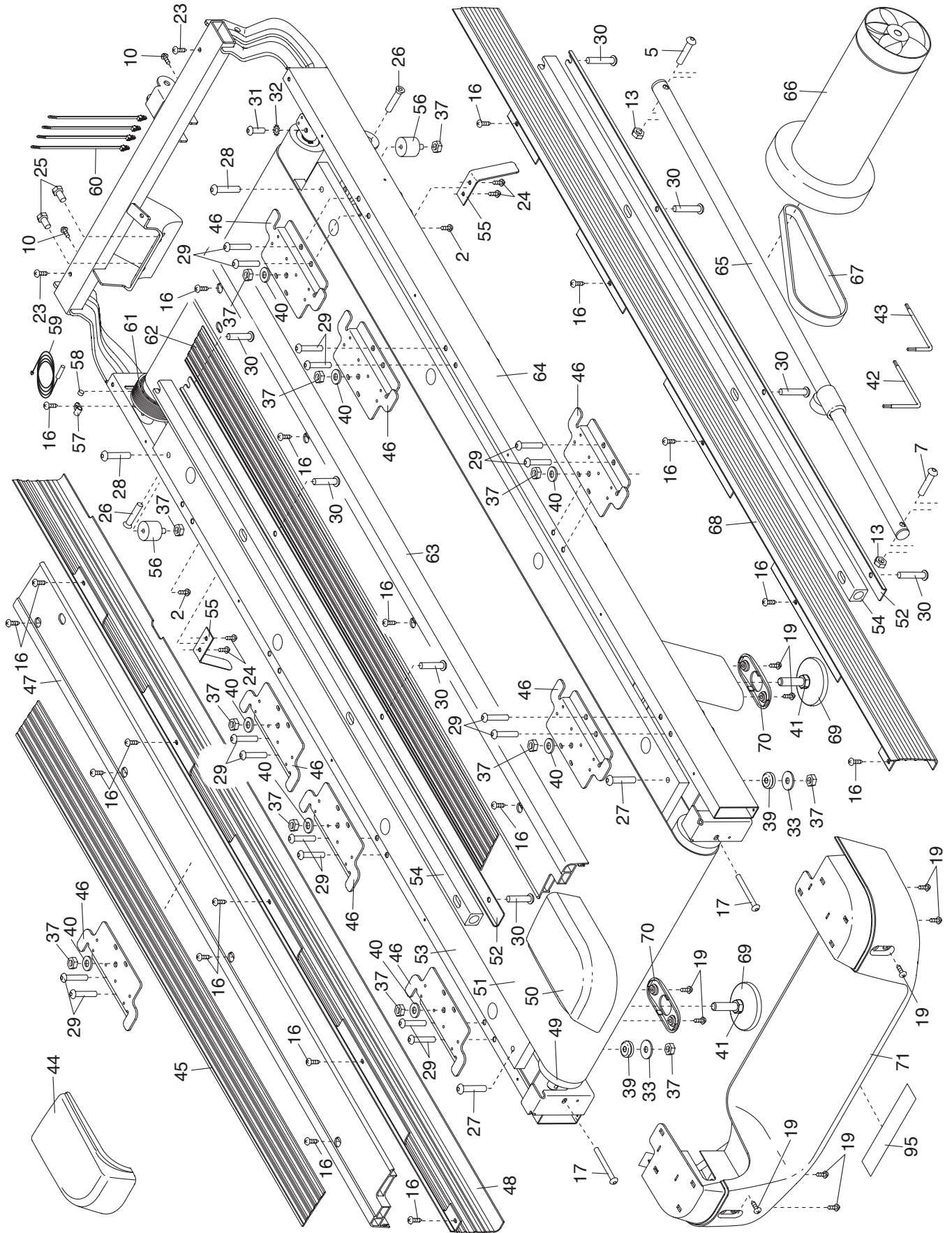

EXPLODED DRAWING B

Model No. PFTL14011.2 R1213A

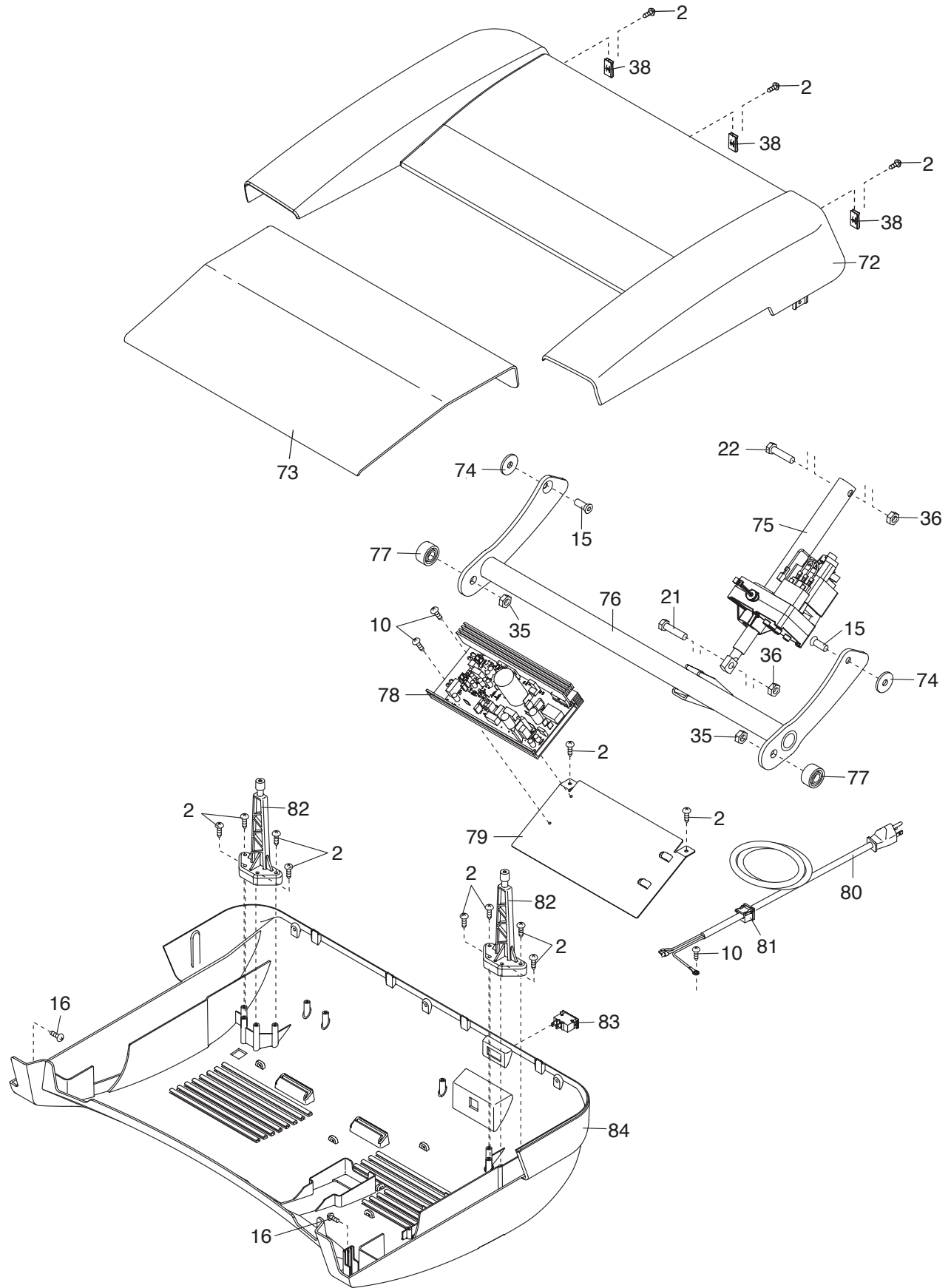

EXPLODED DRAWING C

Model No. PFTL14011.2 R1213A

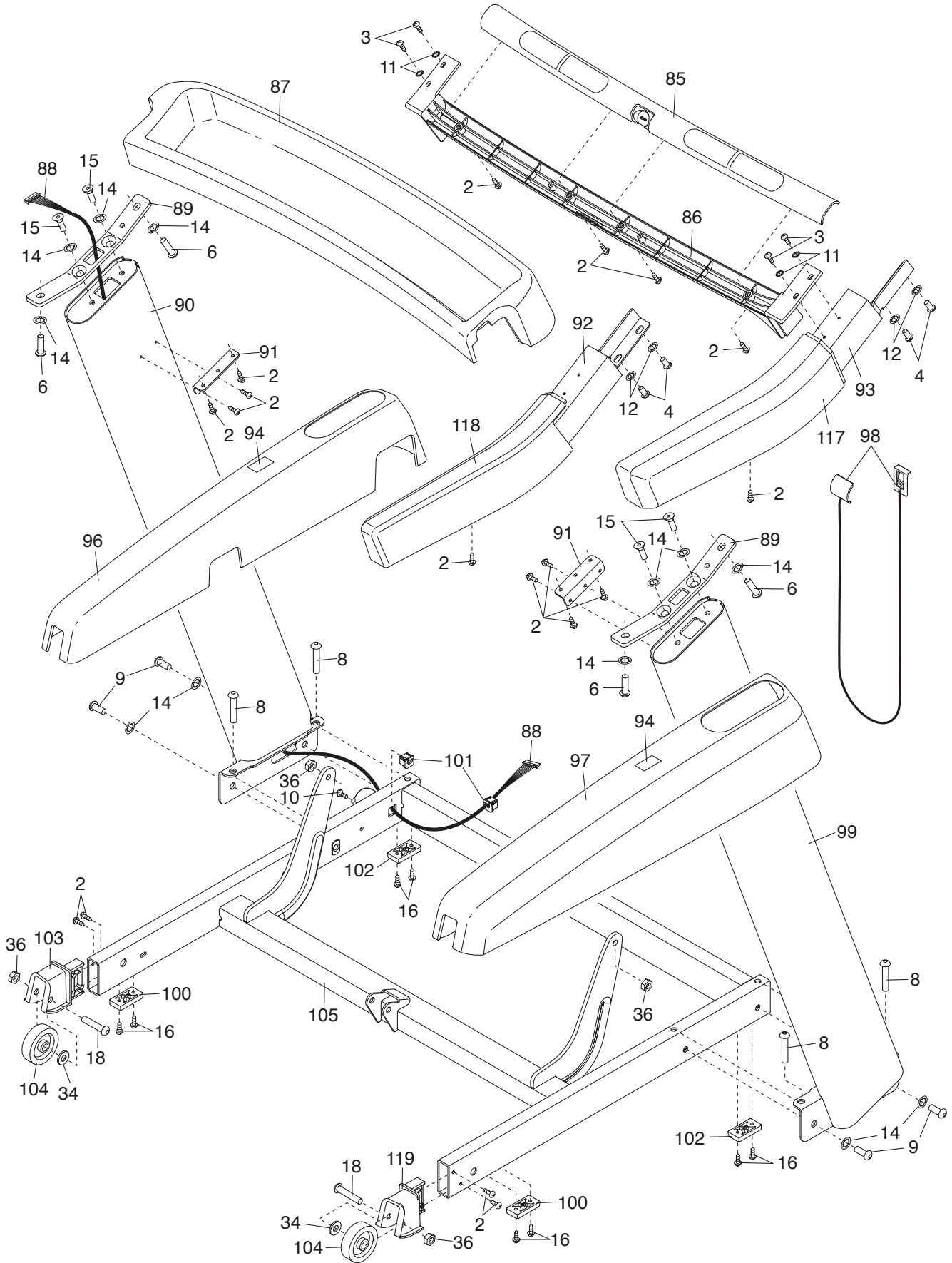

EXPLODED DRAWING D

Model No. PFTL14011.2 R1213A

