

EXPLODED DRAWING A

Model No. PFTL14214.1 R0415A

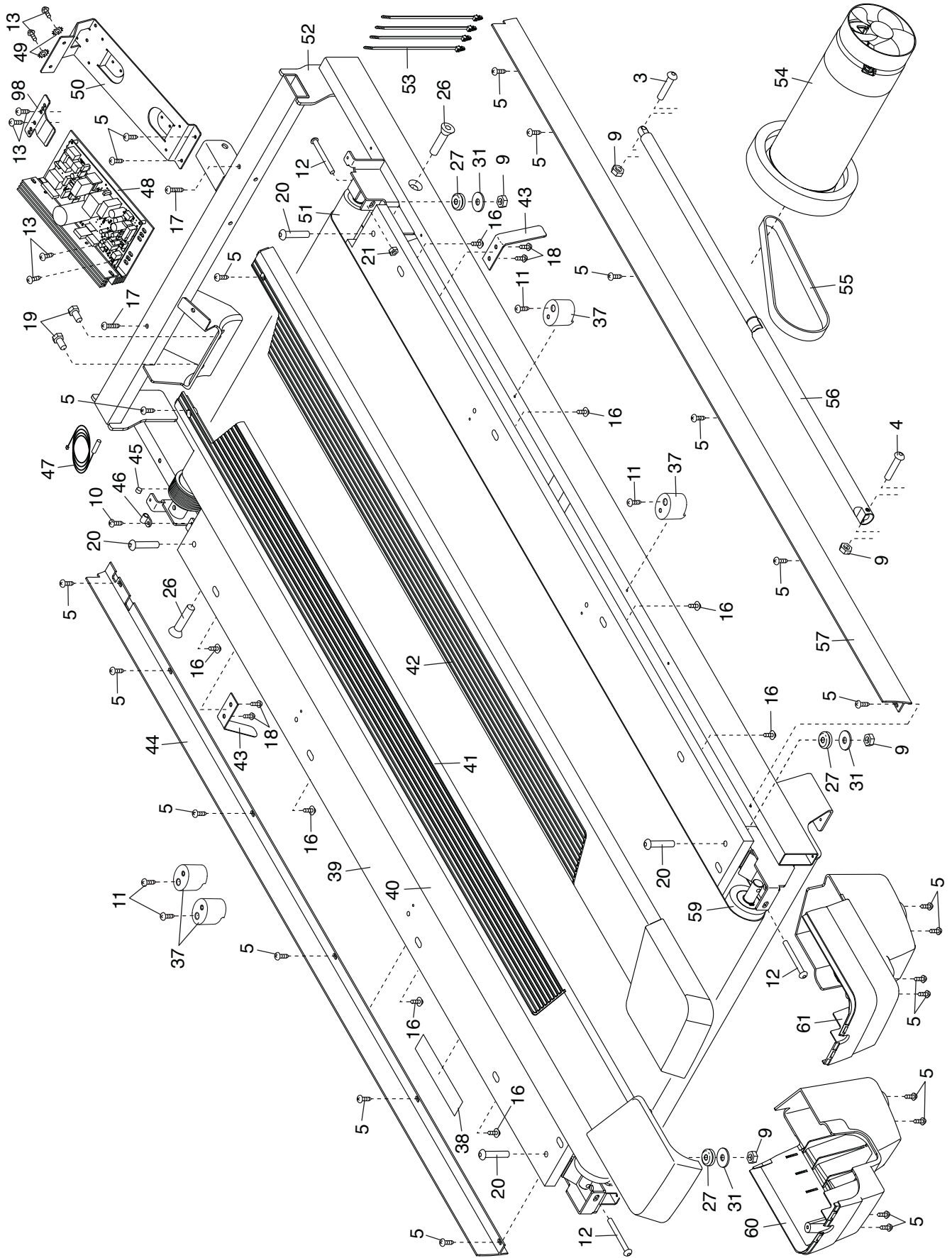

EXPLODED DRAWING B

Model No. PFTL14214.1 R0415A

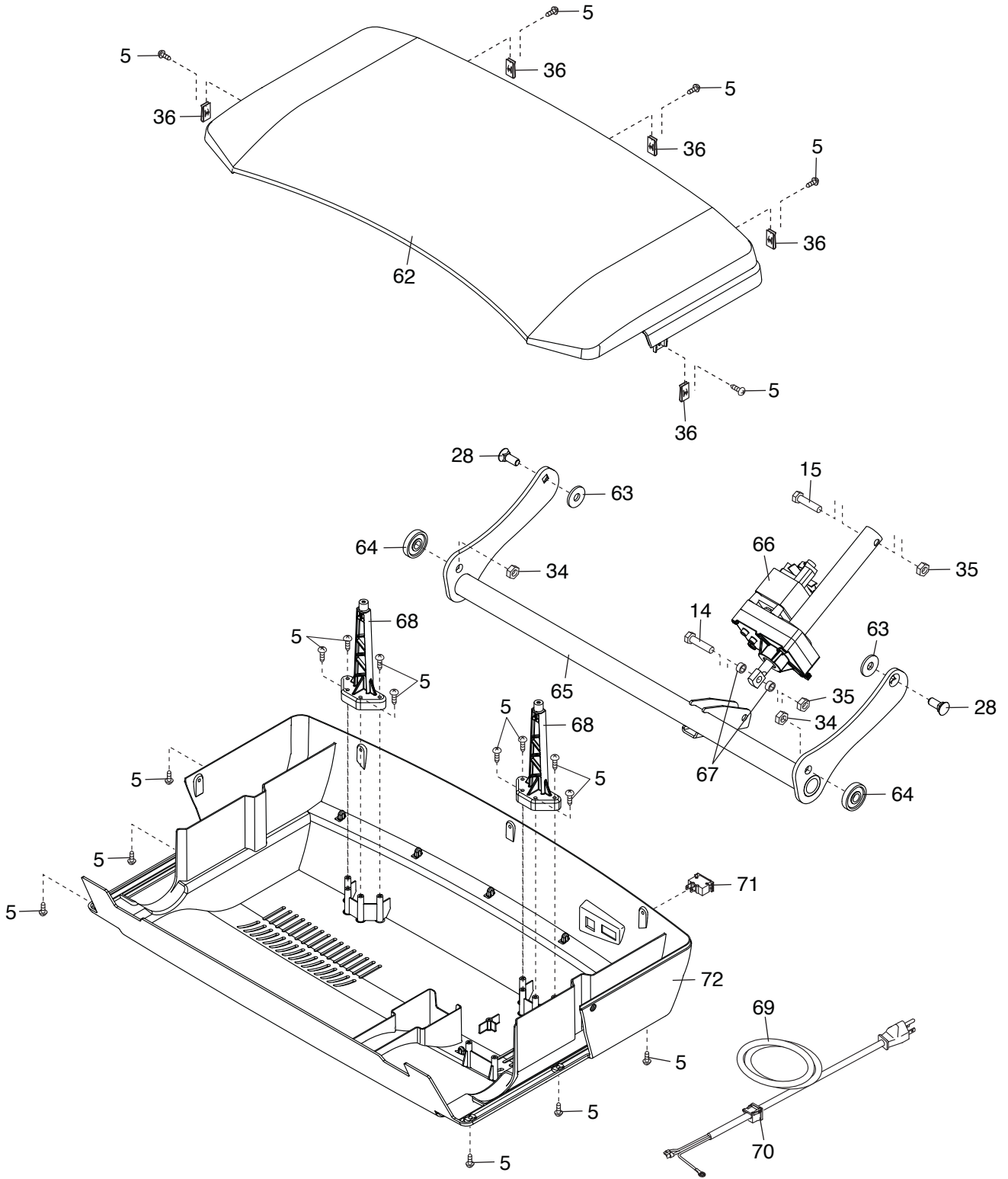

EXPLODED DRAWING C

Model No. PFTL14214.1 R0415A

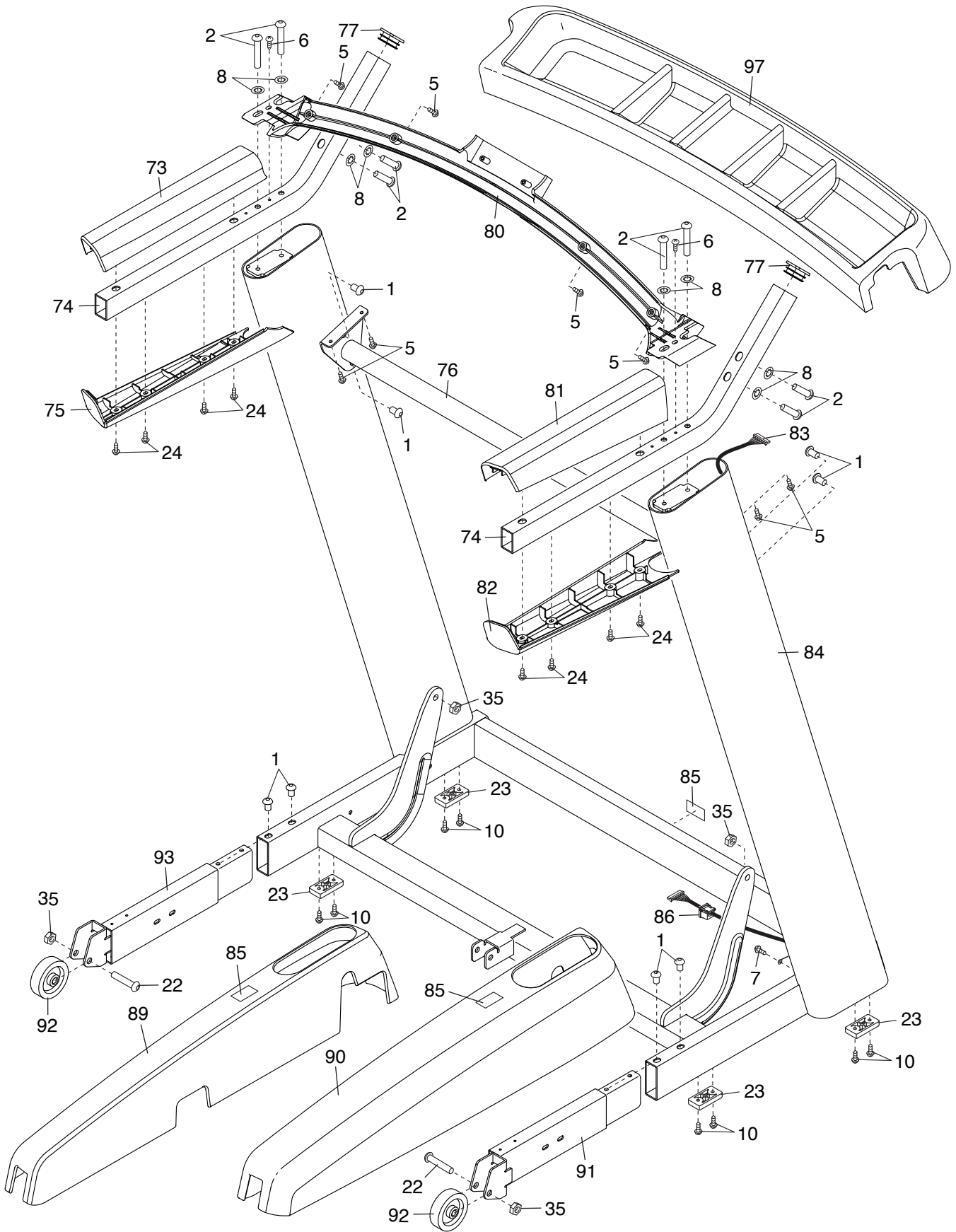

EXPLODED DRAWING D

Model No. PFTL14214.1 R0415A

