

EXPLODED DRAWING A

Model No. PFTL14511.0 R0311A

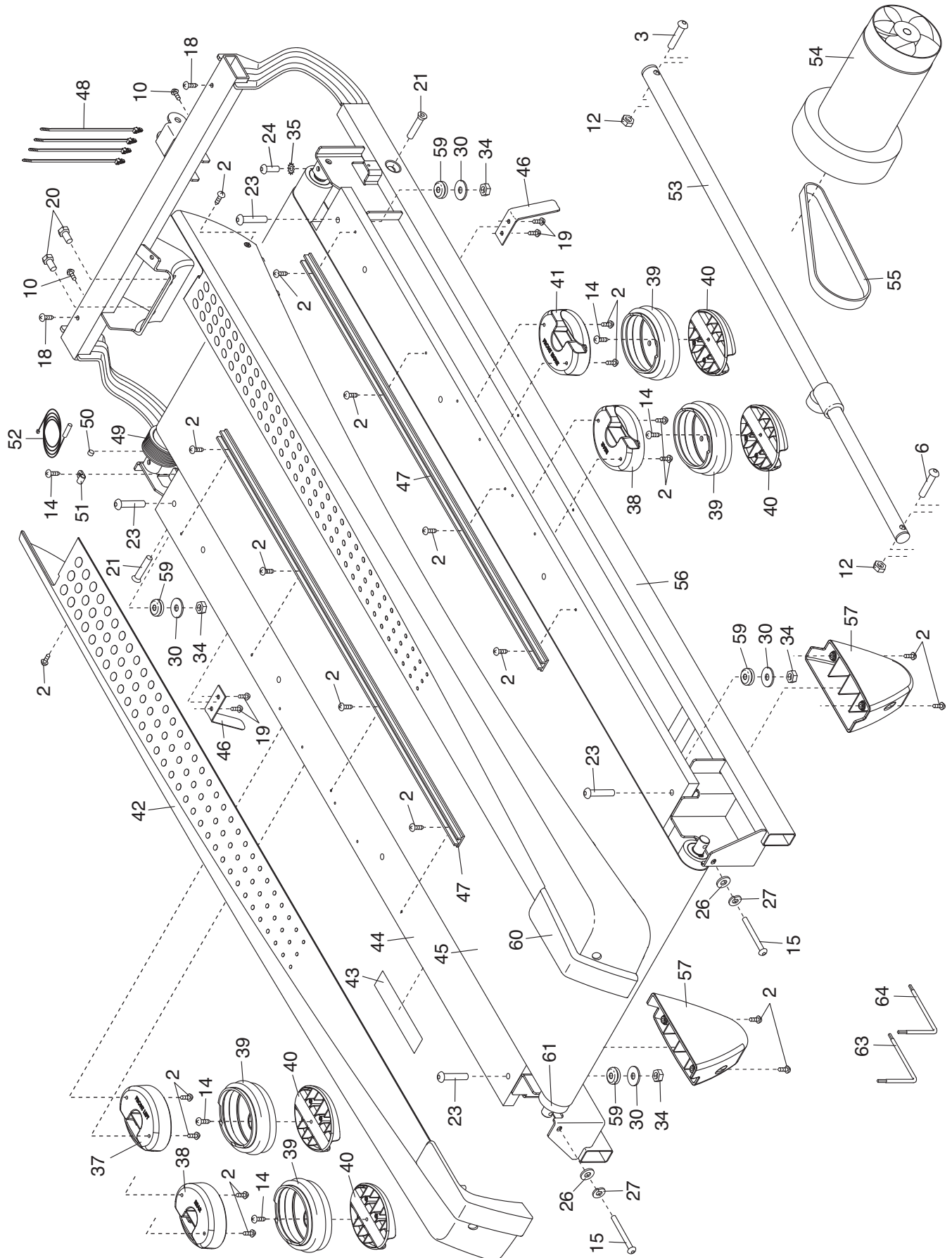

EXPLODED DRAWING B

Model No. PFTL14511.0 R0311A

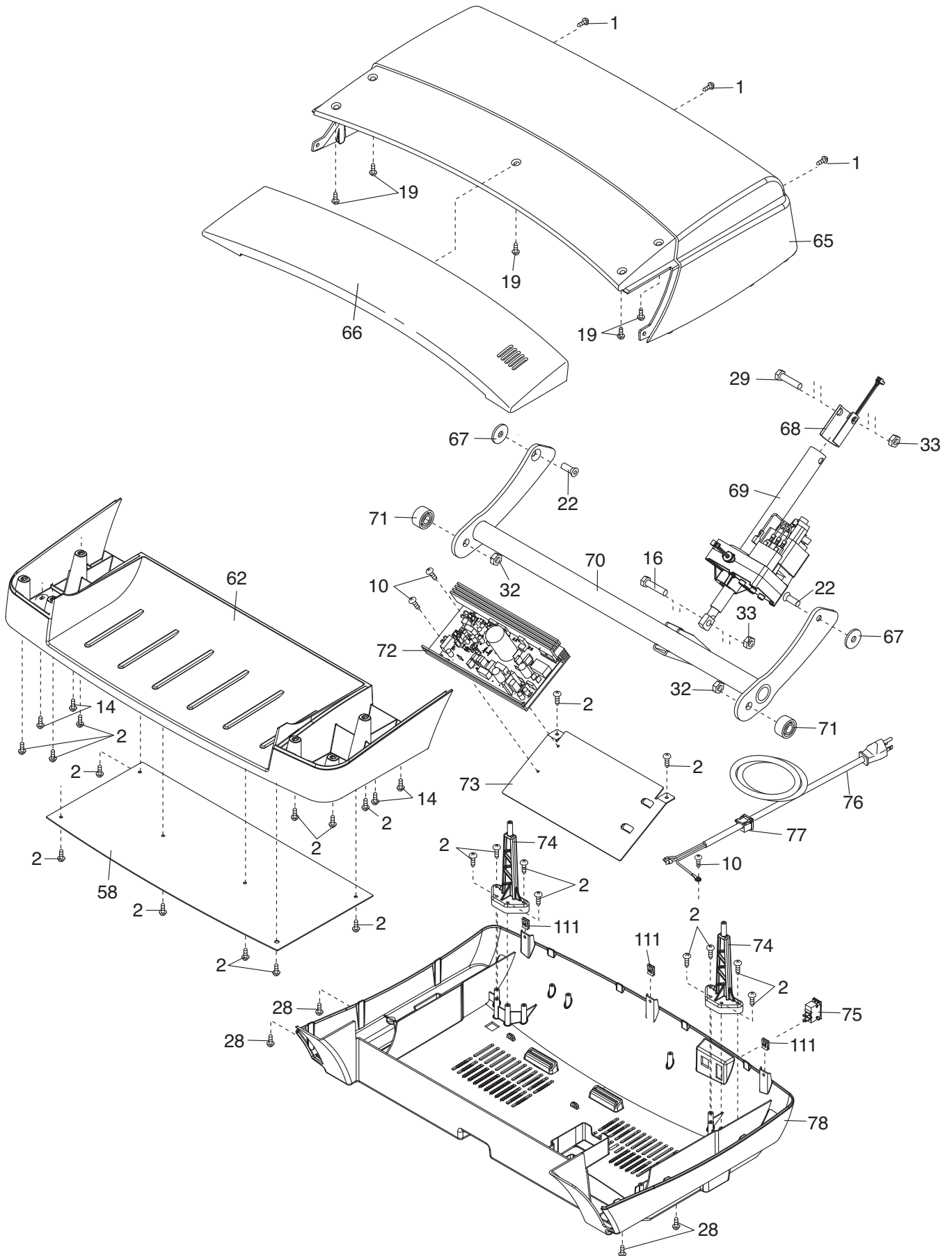

EXPLODED DRAWING C

Model No. PFTL14511.0 R0311A

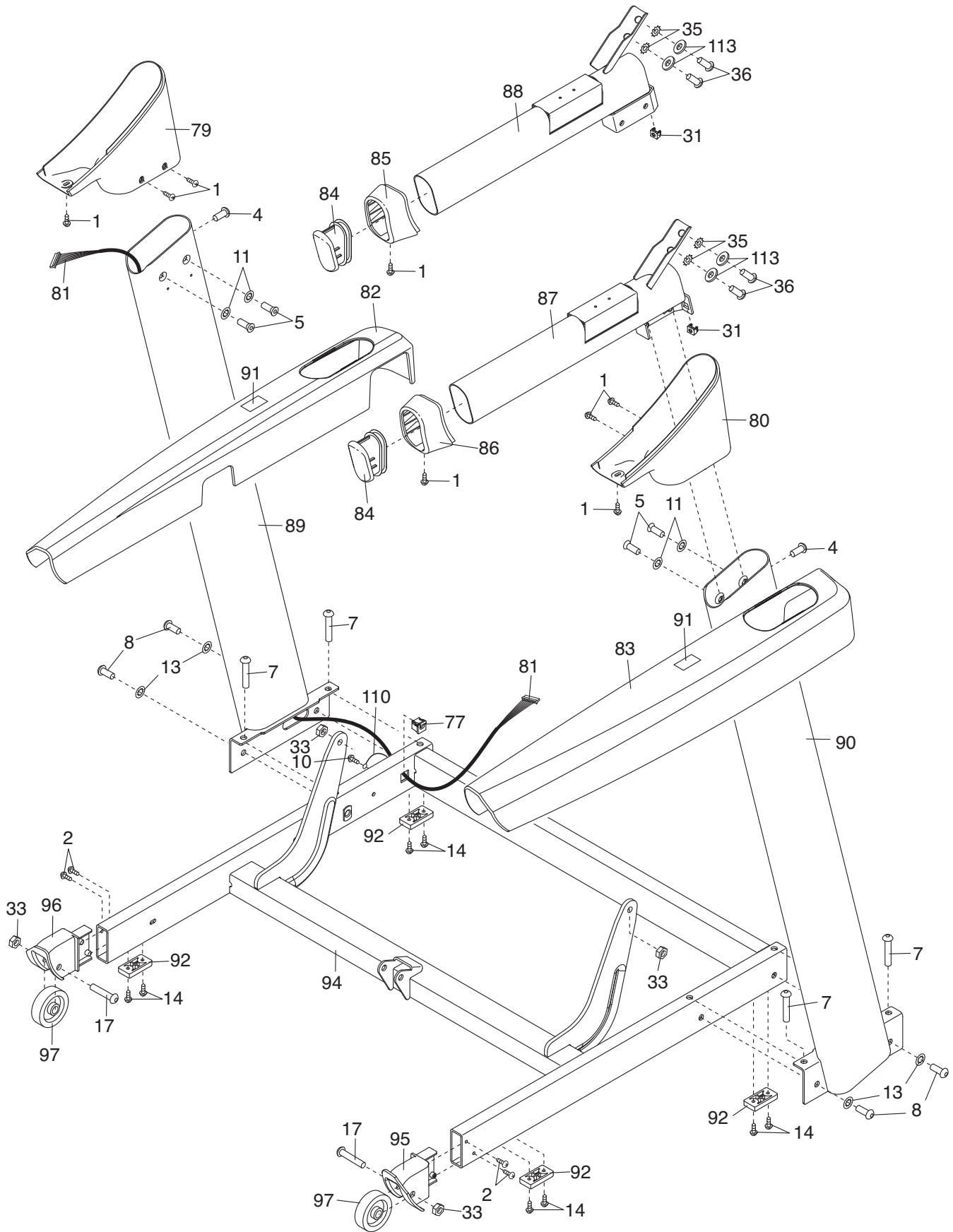

EXPLODED DRAWING D

Model No. PFTL14511.0 R0311A

