

EXPLODED DRAWING A

Model No. PFTL14613.2 R0814A

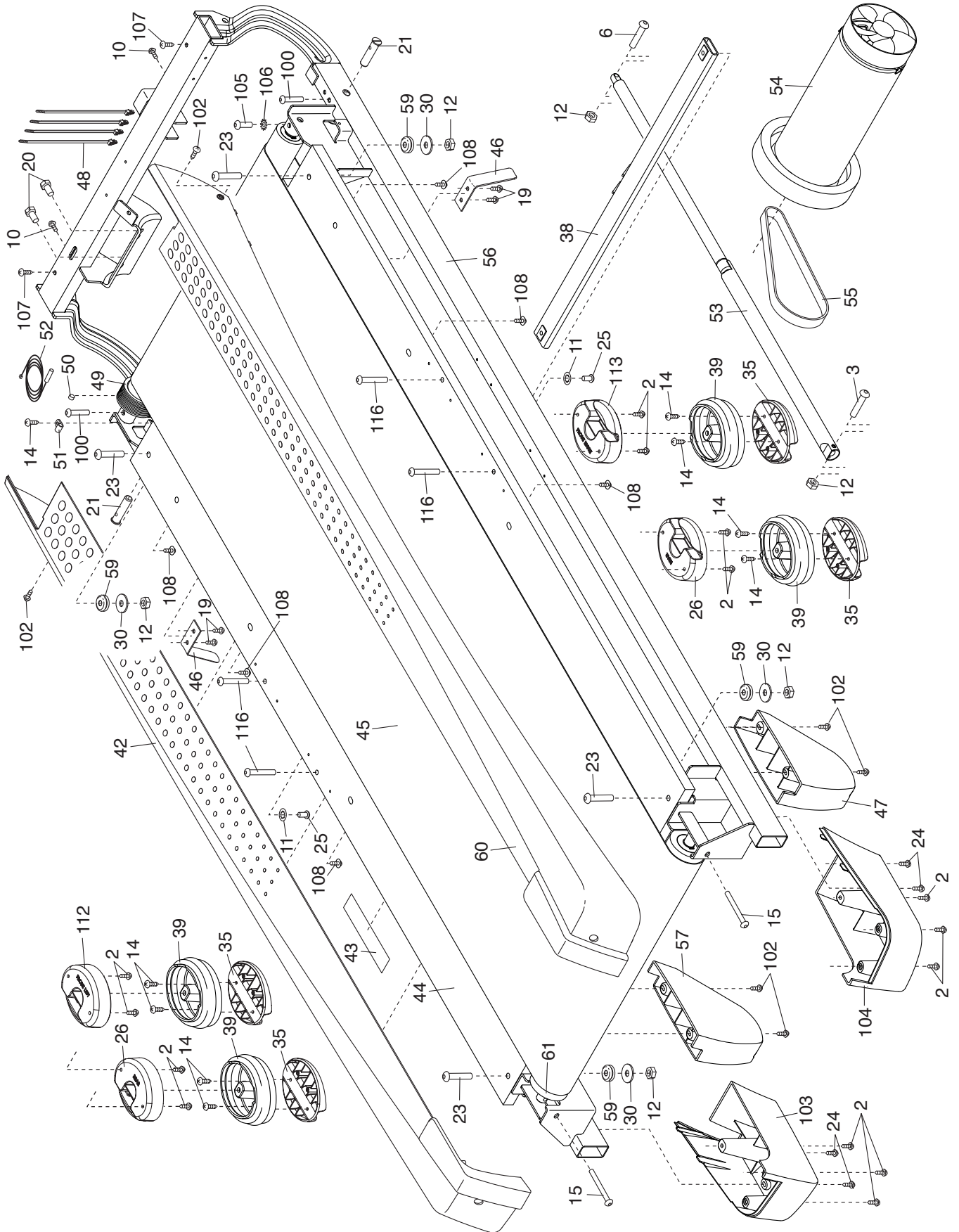

EXPLODED DRAWING B

Model No. PFTL14613.2 R0814A

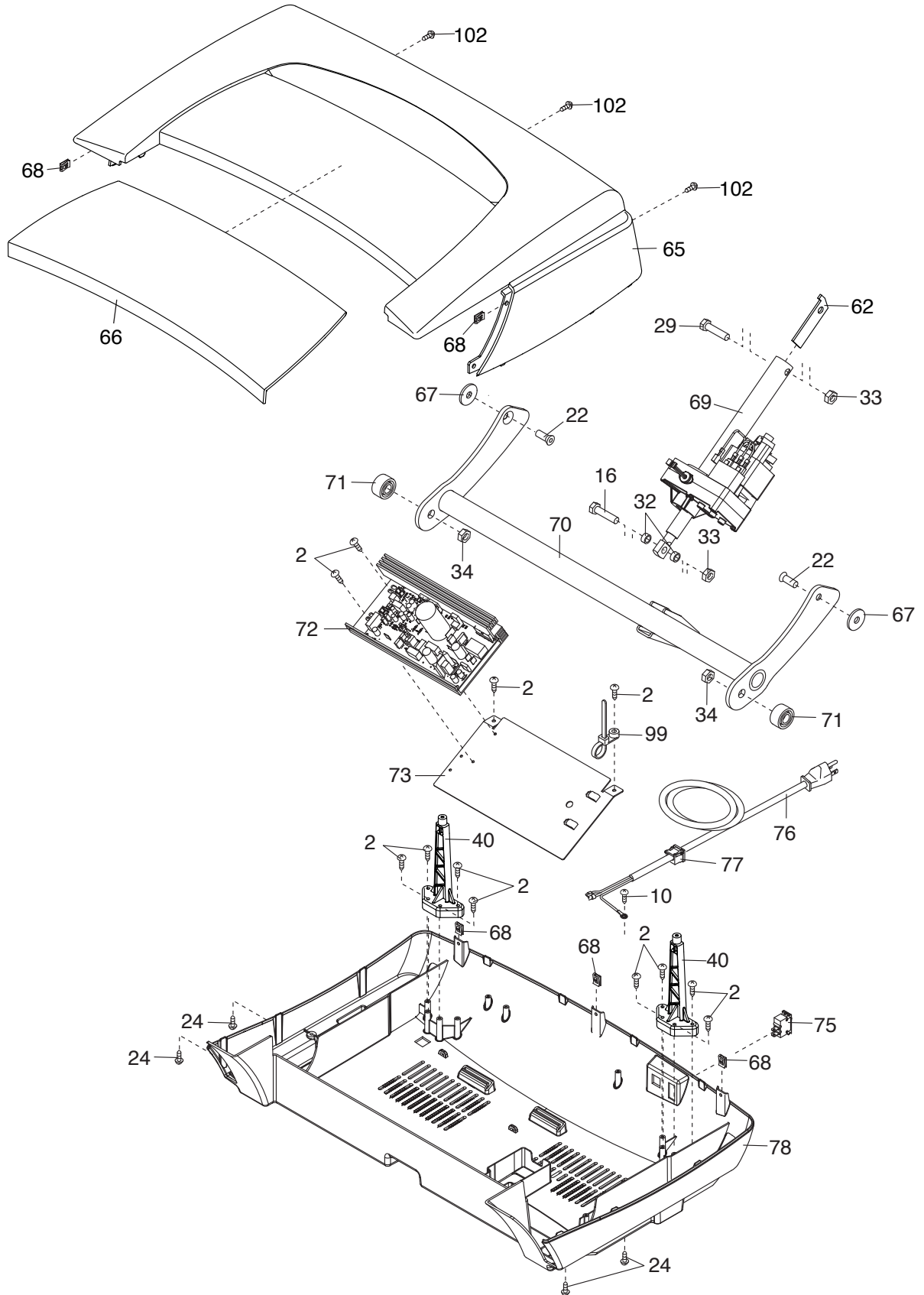

EXPLODED DRAWING C

Model No. PFTL14613.2 R0814A

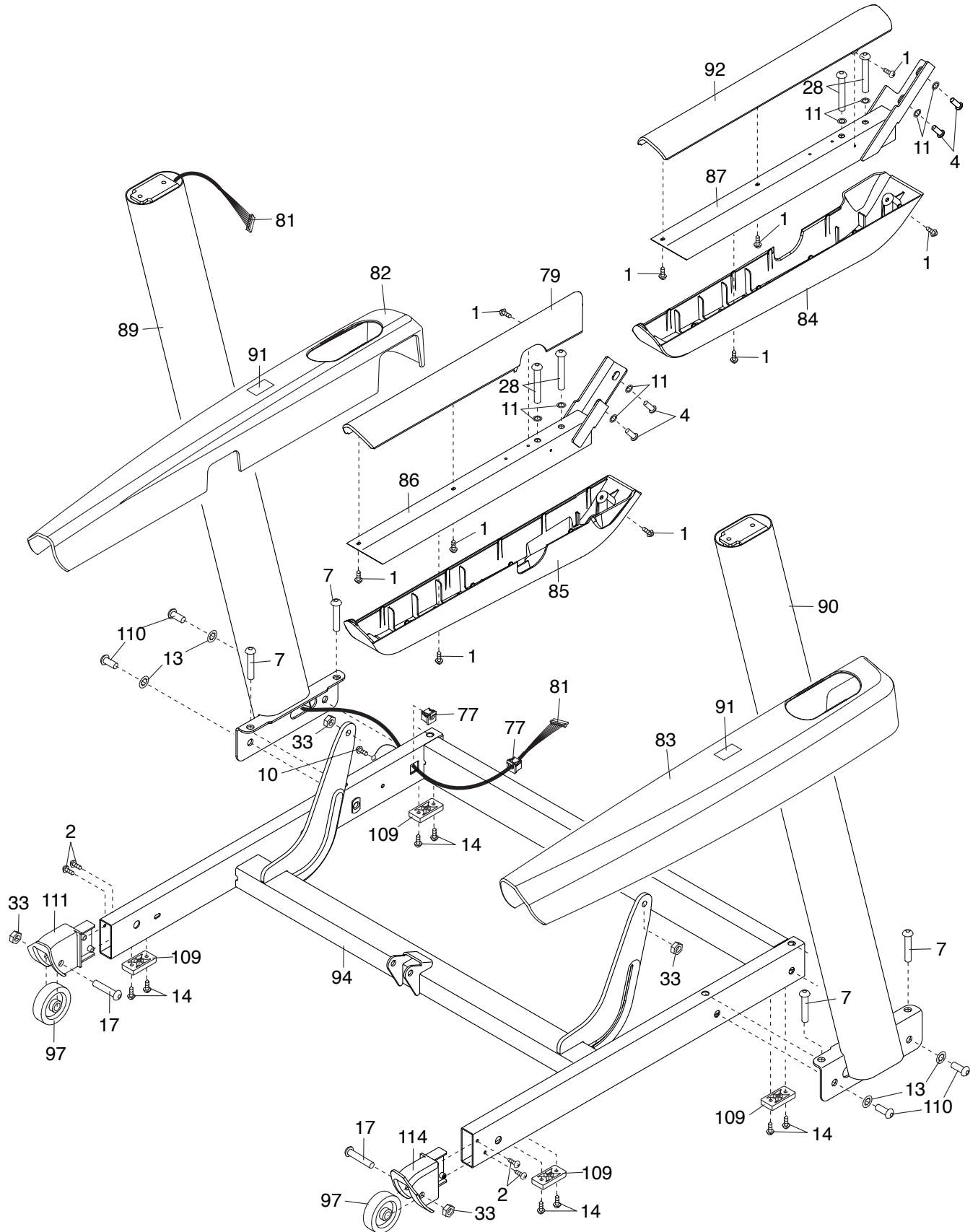

EXPLODED DRAWING D

Model No. PFTL14613.2 R0814A

