

EXPLODED DRAWING—Model No. PFTL14920

R0102A

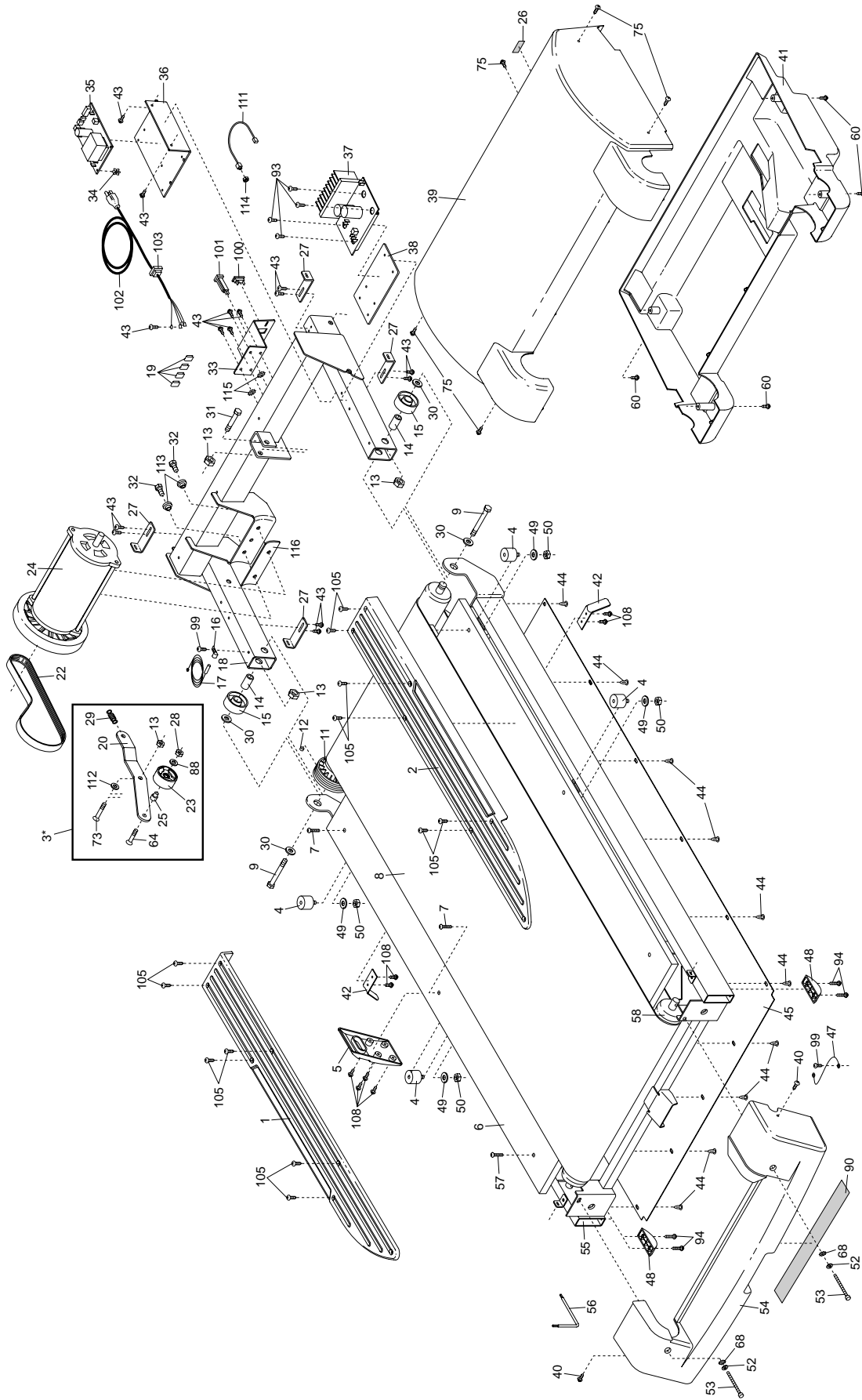

EXPLODED DRAWING—Model No. PFTL14920

R0102A

