

EXPLODED DRAWING—Model No. PFTL14923

R0602A

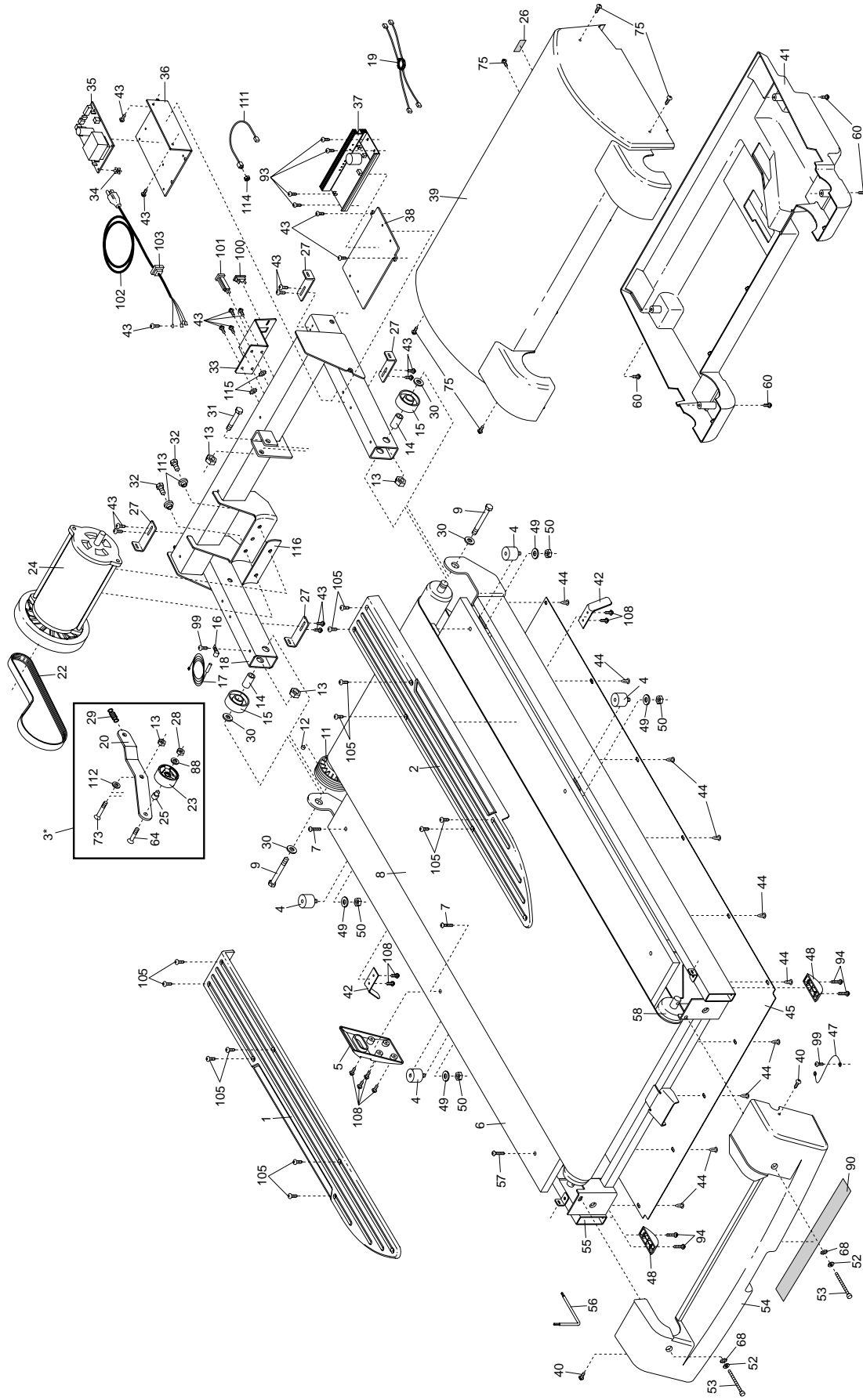

EXPLODED DRAWING—Model No. PFTL14923

R0602A

