

EXPLODED DRAWING A

Model No. PFTL15116.0 R1016A

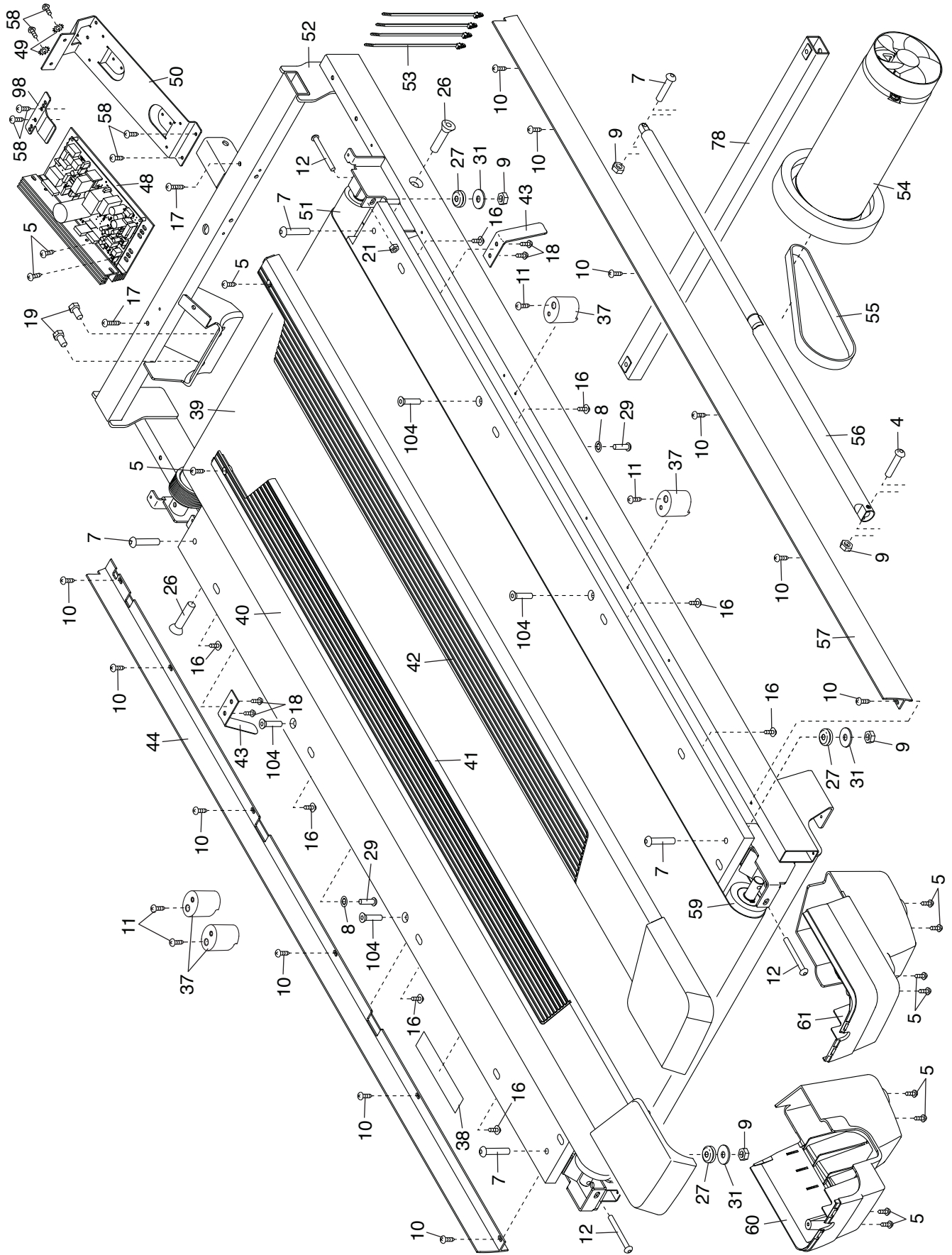

EXPLODED DRAWING B

Model No. PFTL15116.0 R1016A

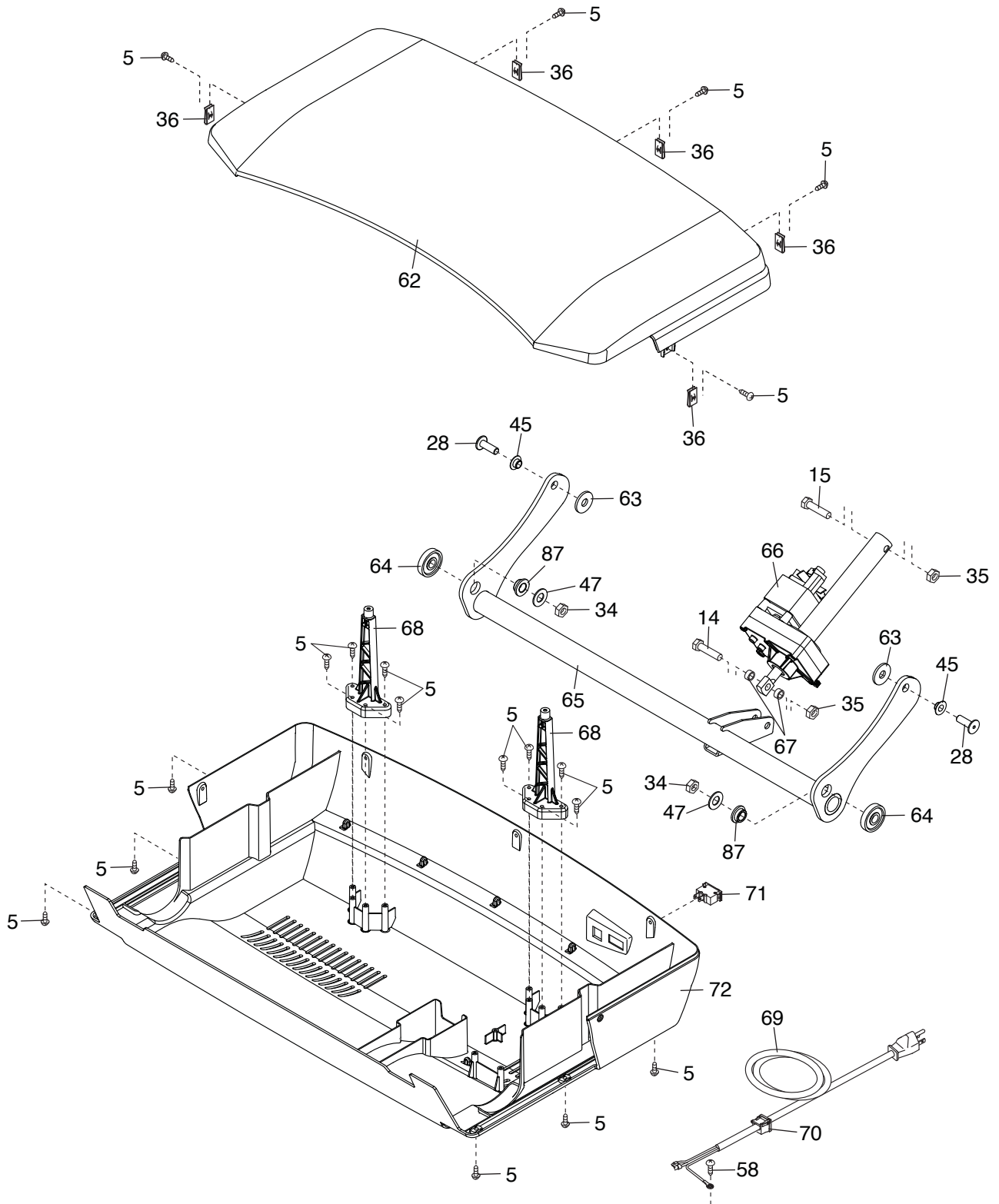

EXPLODED DRAWING C

Model No. PFTL15116.0 R1016A

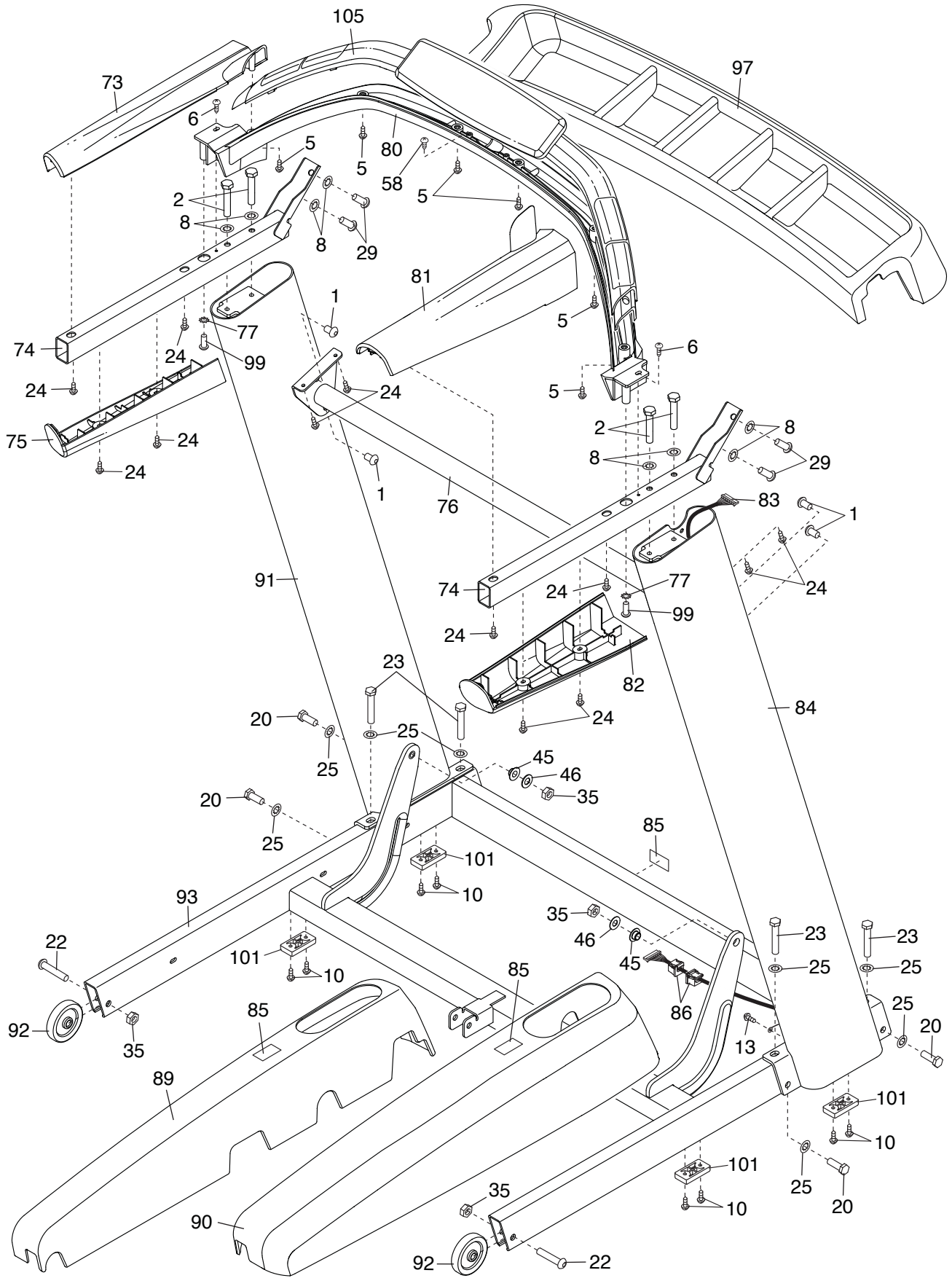

EXPLODED DRAWING D

Model No. PFTL15116.0 R1016A

