

# EXPLODED DRAWING A

Model No. PFTL15118.1 R0918A

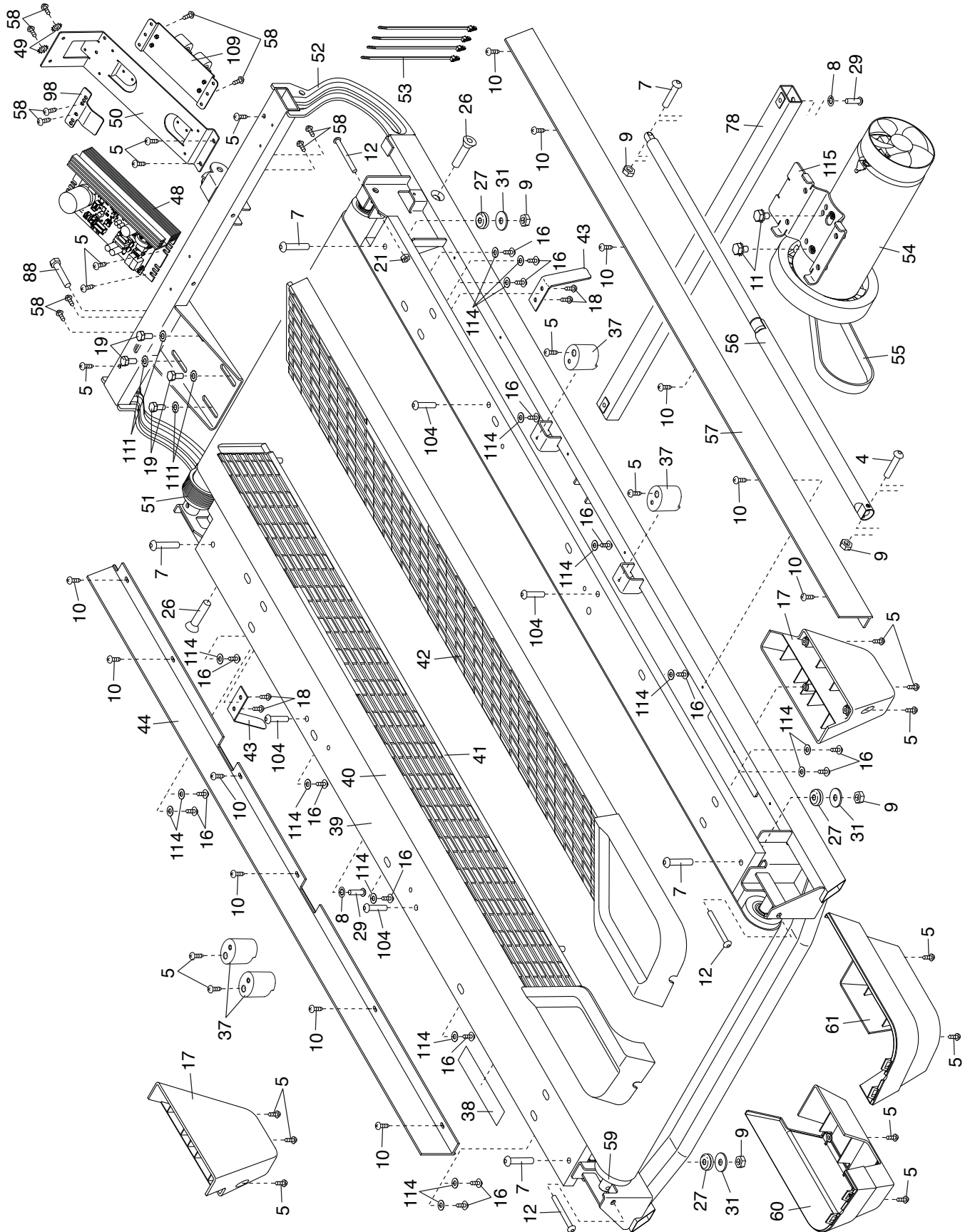

# EXPLODED DRAWING B

Model No. PFTL15118.1 R0918A

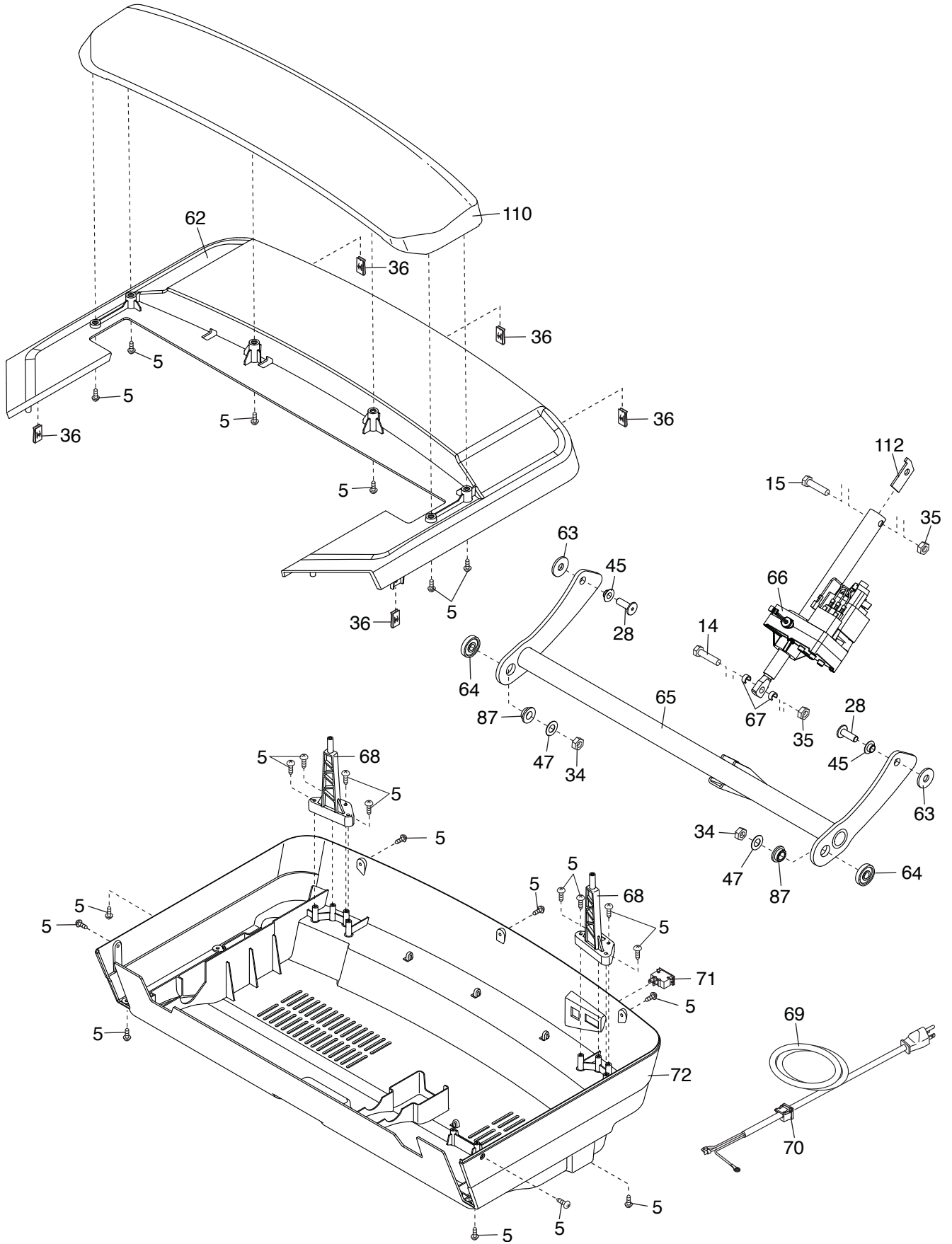

# EXPLODED DRAWING C

Model No. PFTL15118.1 R0918A

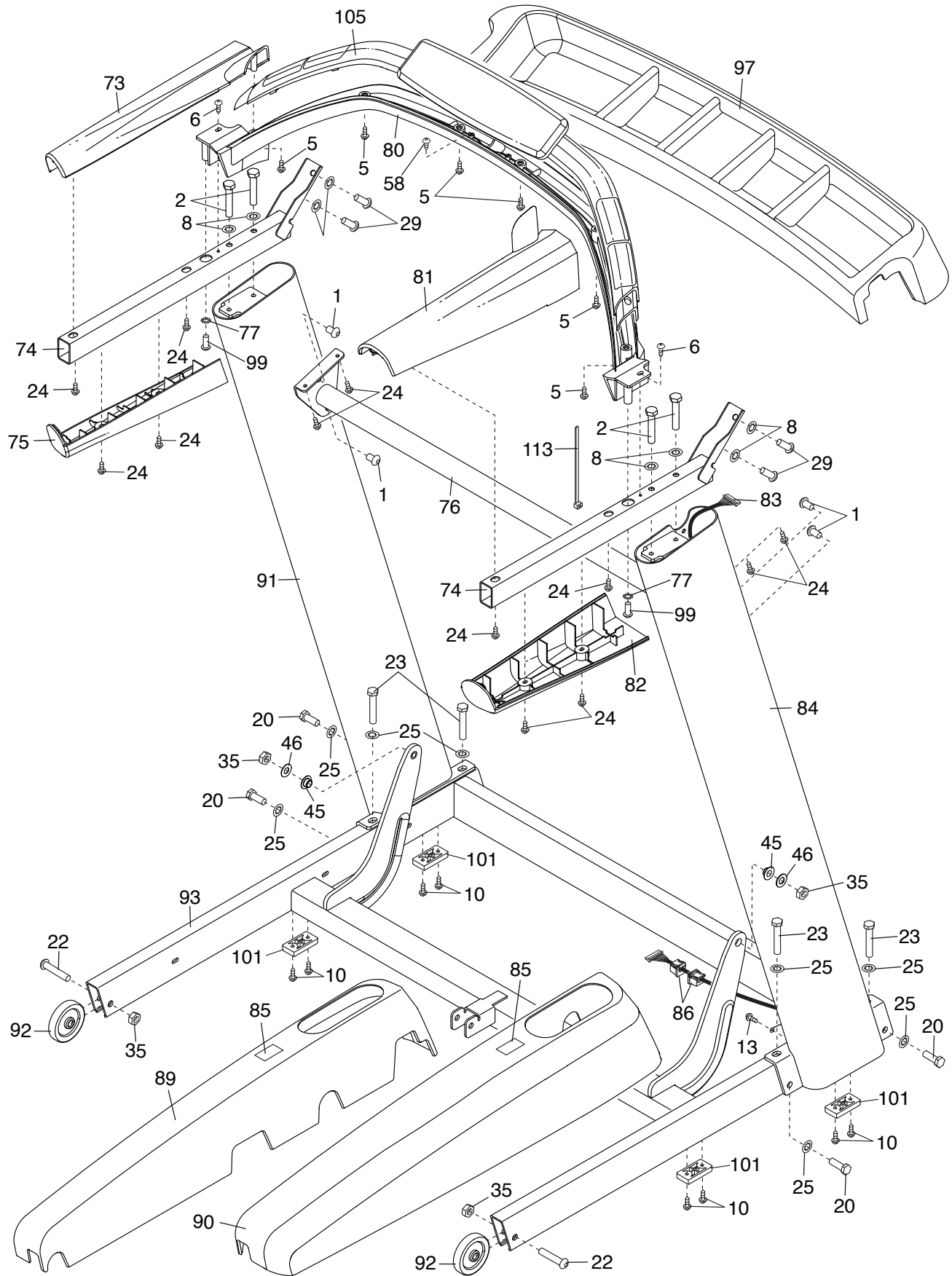

# EXPLODED DRAWING D

Model No. PFTL15118.1 R0918A

