

EXPLODED DRAWING A

Model No. PFTL15820.4 R0222A

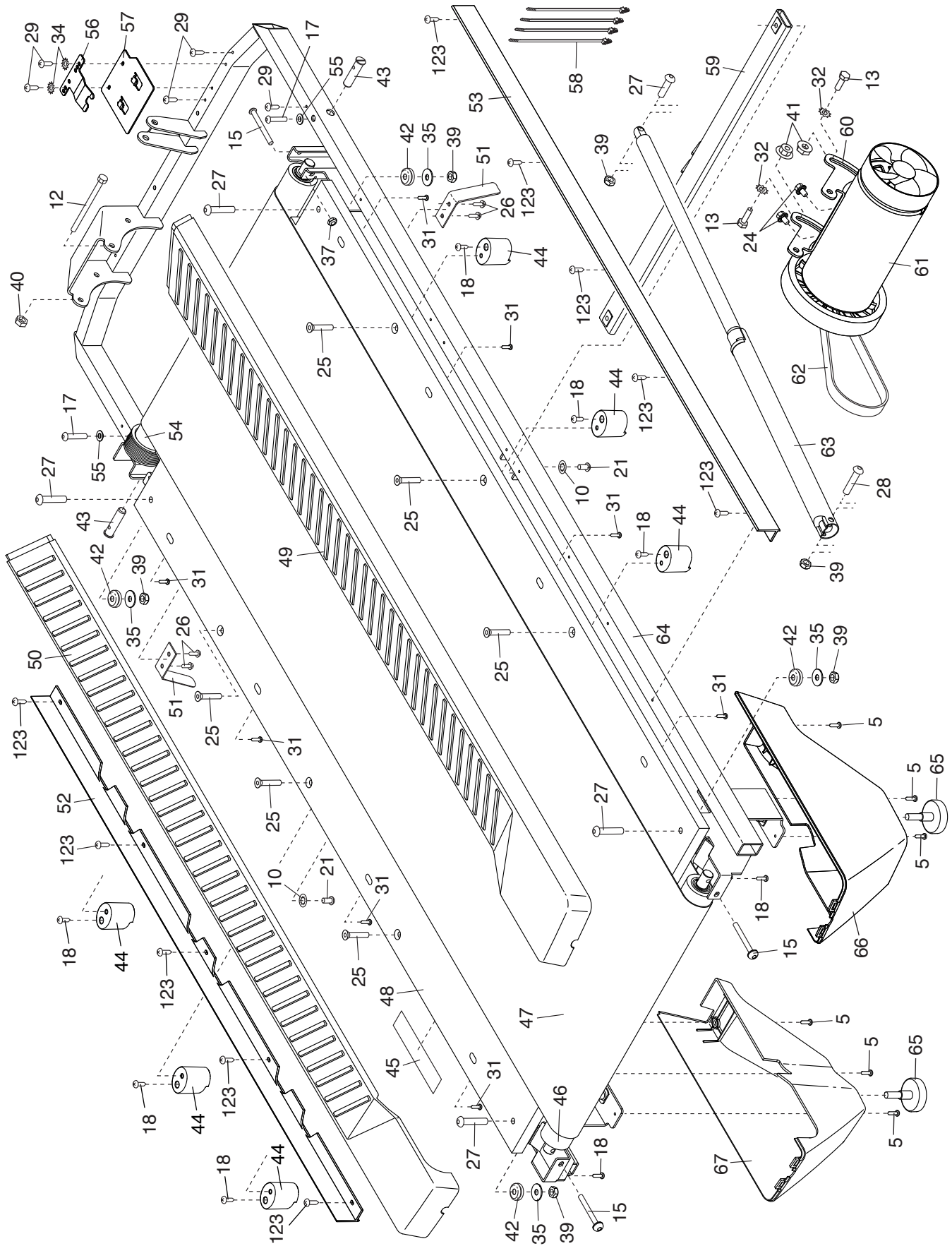

EXPLODED DRAWING B

Model No. PFTL15820.4 R0222A

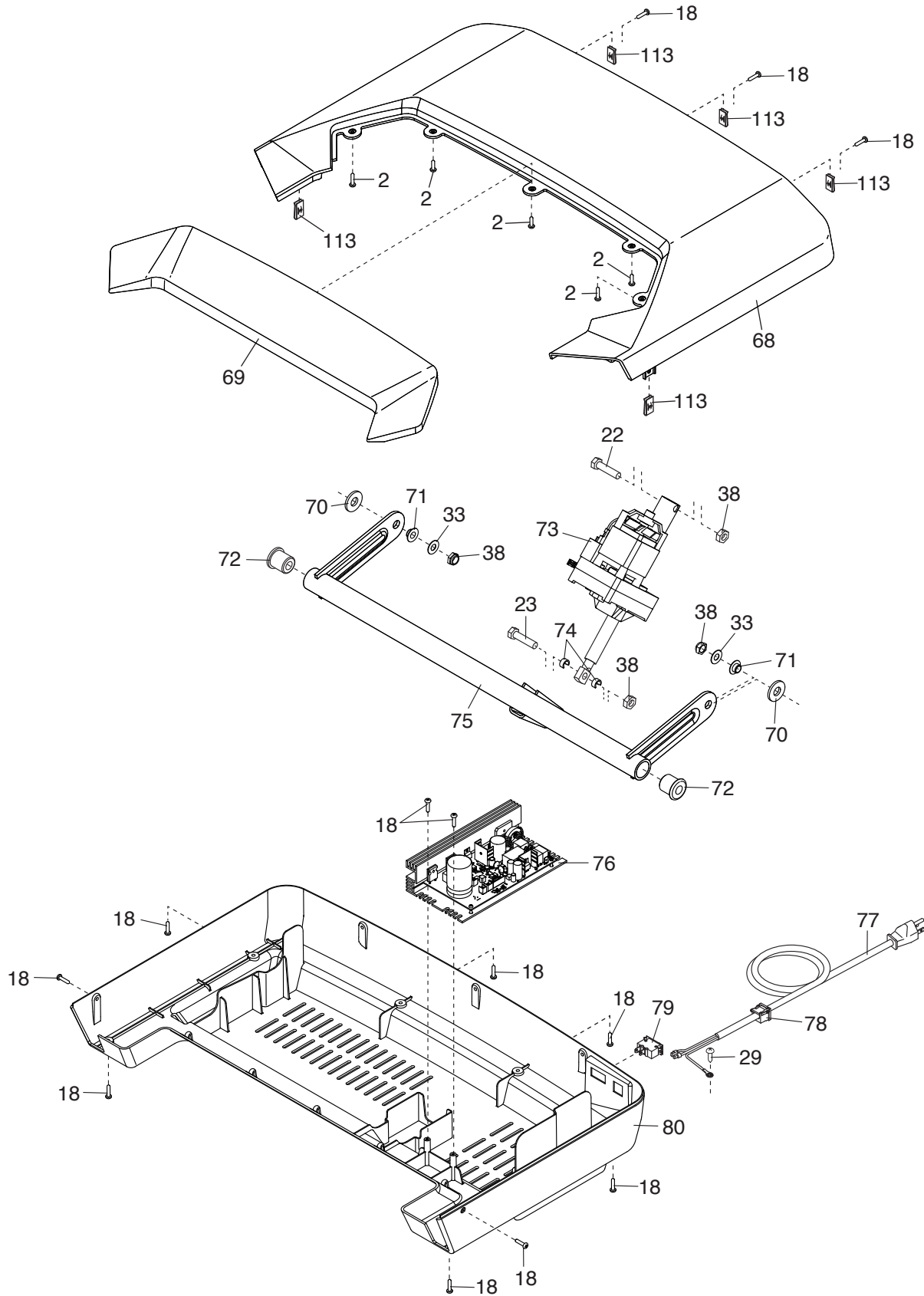

EXPLODED DRAWING C

Model No. PFTL15820.4 R0222A

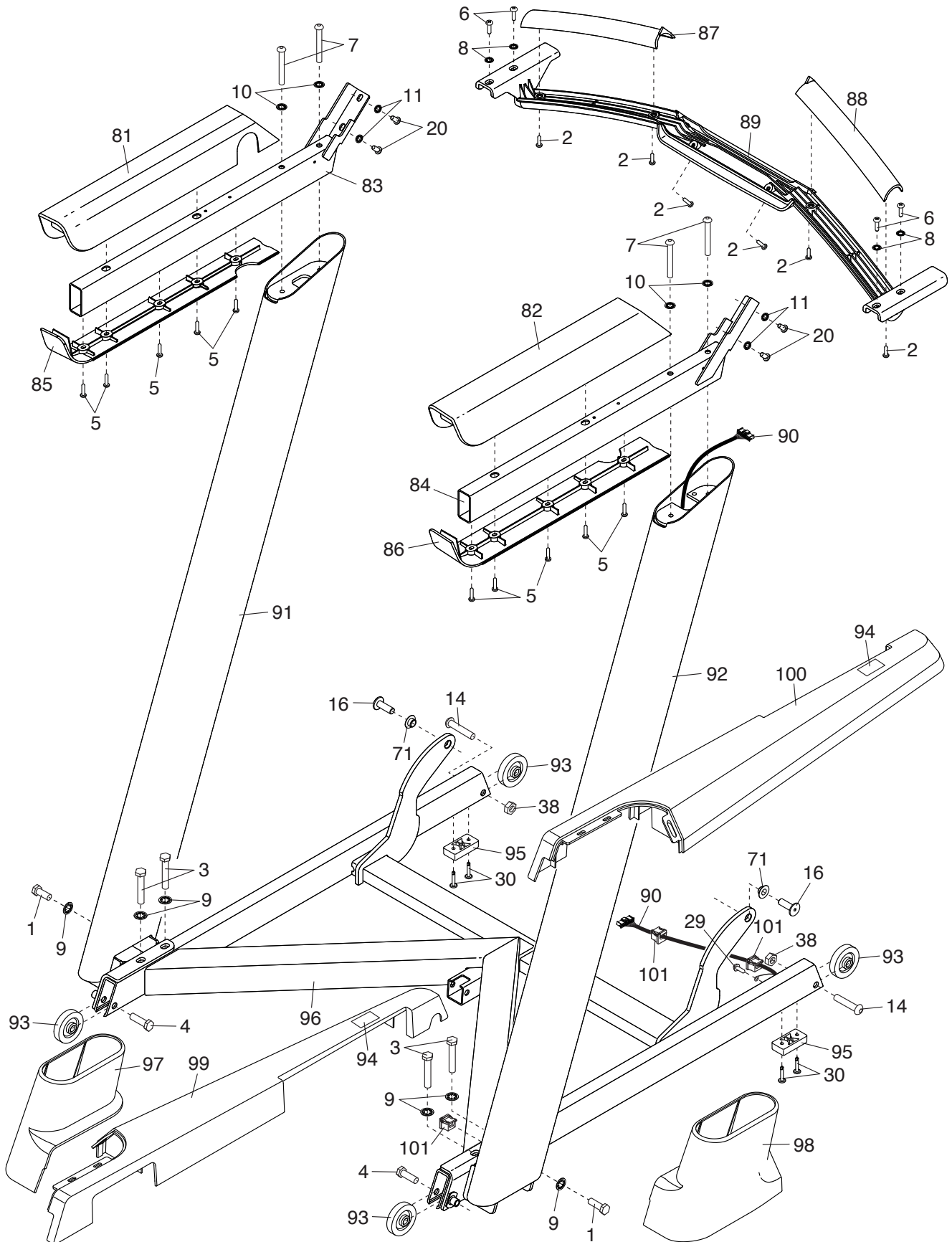

EXPLODED DRAWING D

Model No. PFTL15820.4 R0222A

