

EXPLODED DRAWING A

Model No. PFTL16011.1 R0515A

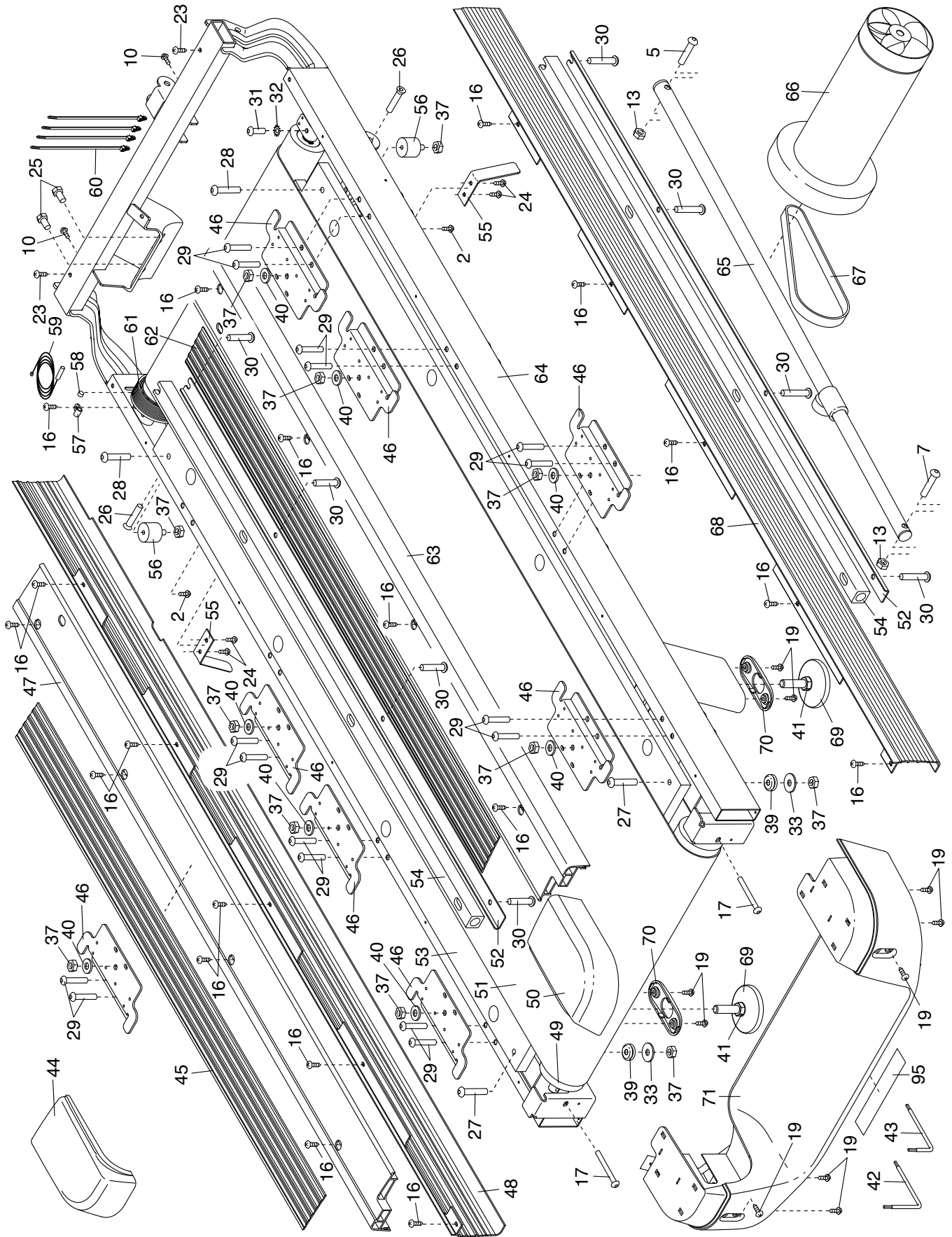

EXPLODED DRAWING B

Model No. PFTL16011.1 R0515A

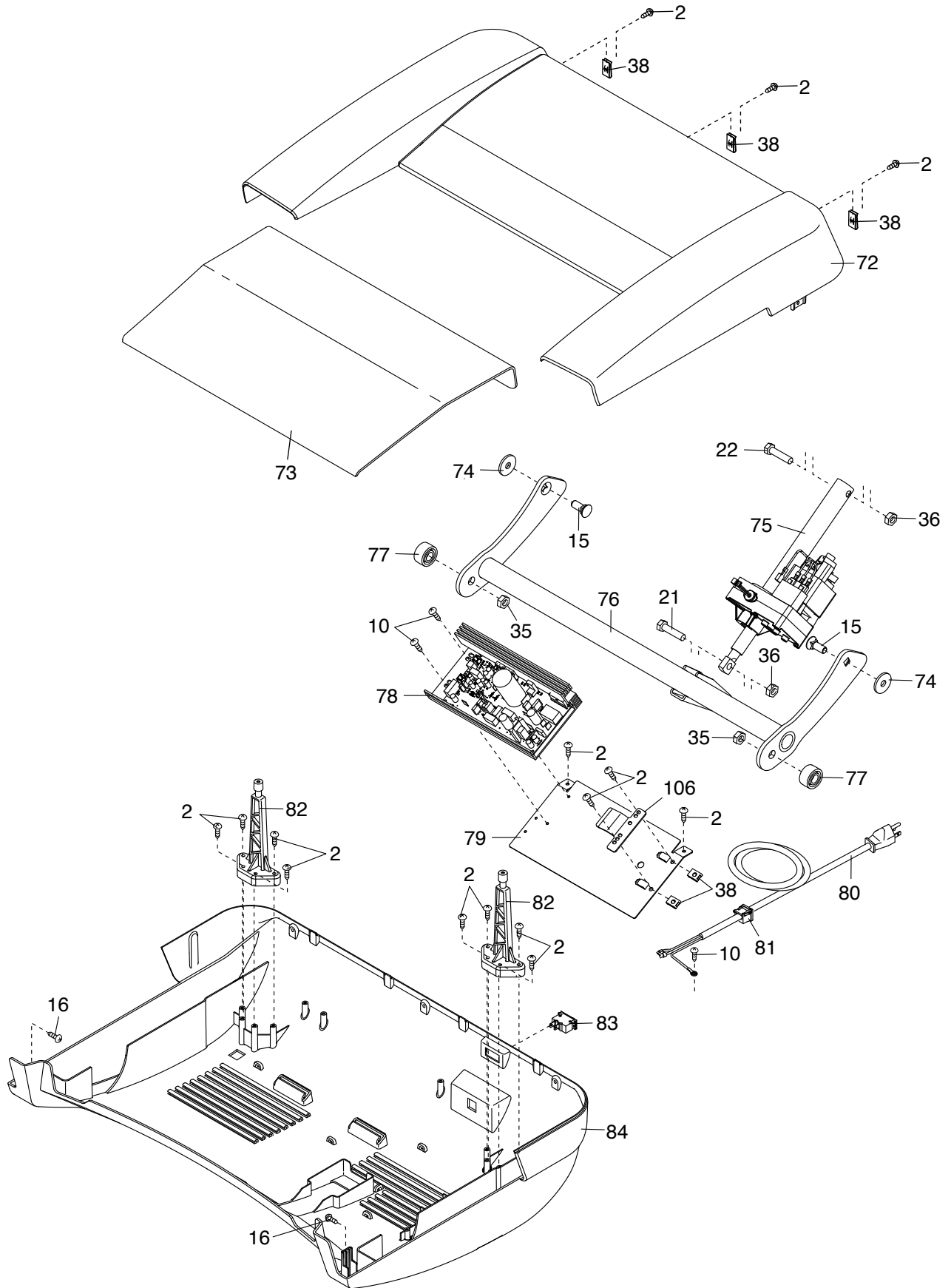

EXPLODED DRAWING D

Model No. PFTL16011.1 R0515A

