

EXPLODED DRAWING A

Model No. PFTL16213.3 R0915A

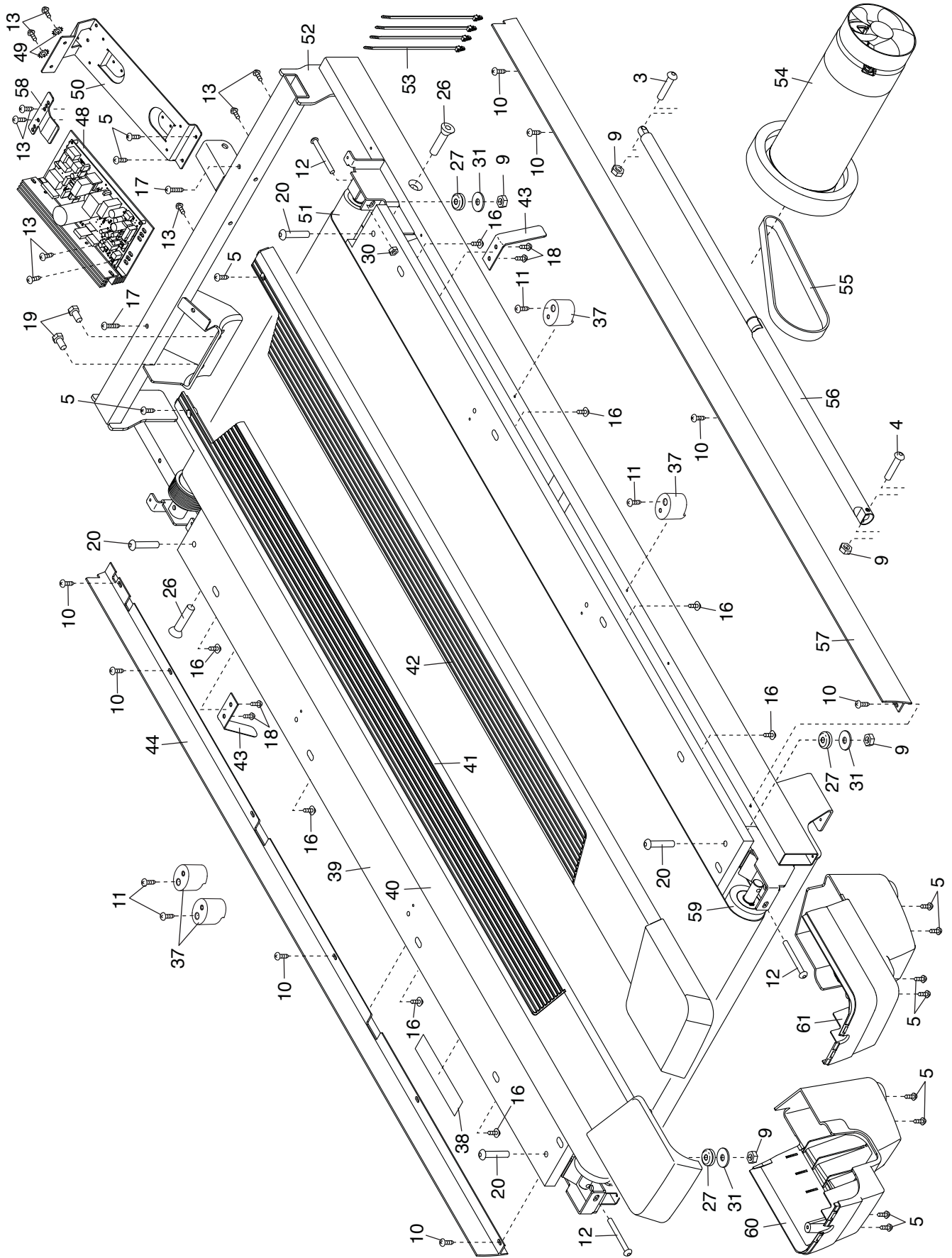

EXPLODED DRAWING B

Model No. PFTL16213.3 R0915A

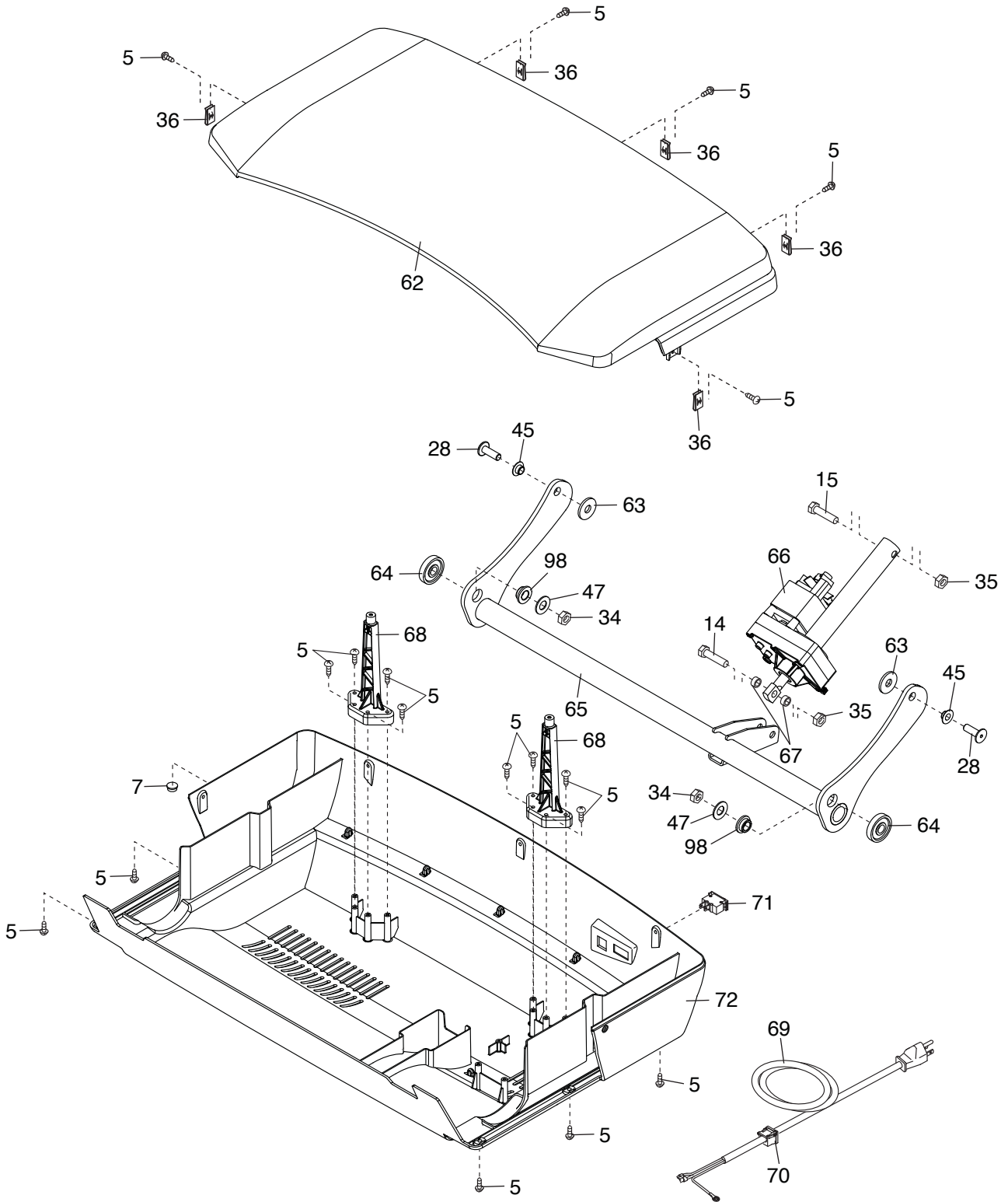

EXPLODED DRAWING C

Model No. PFTL16213.3 R0915A

