

EXPLODED DRAWING A

Model No. PFTL16213.4 R1115A

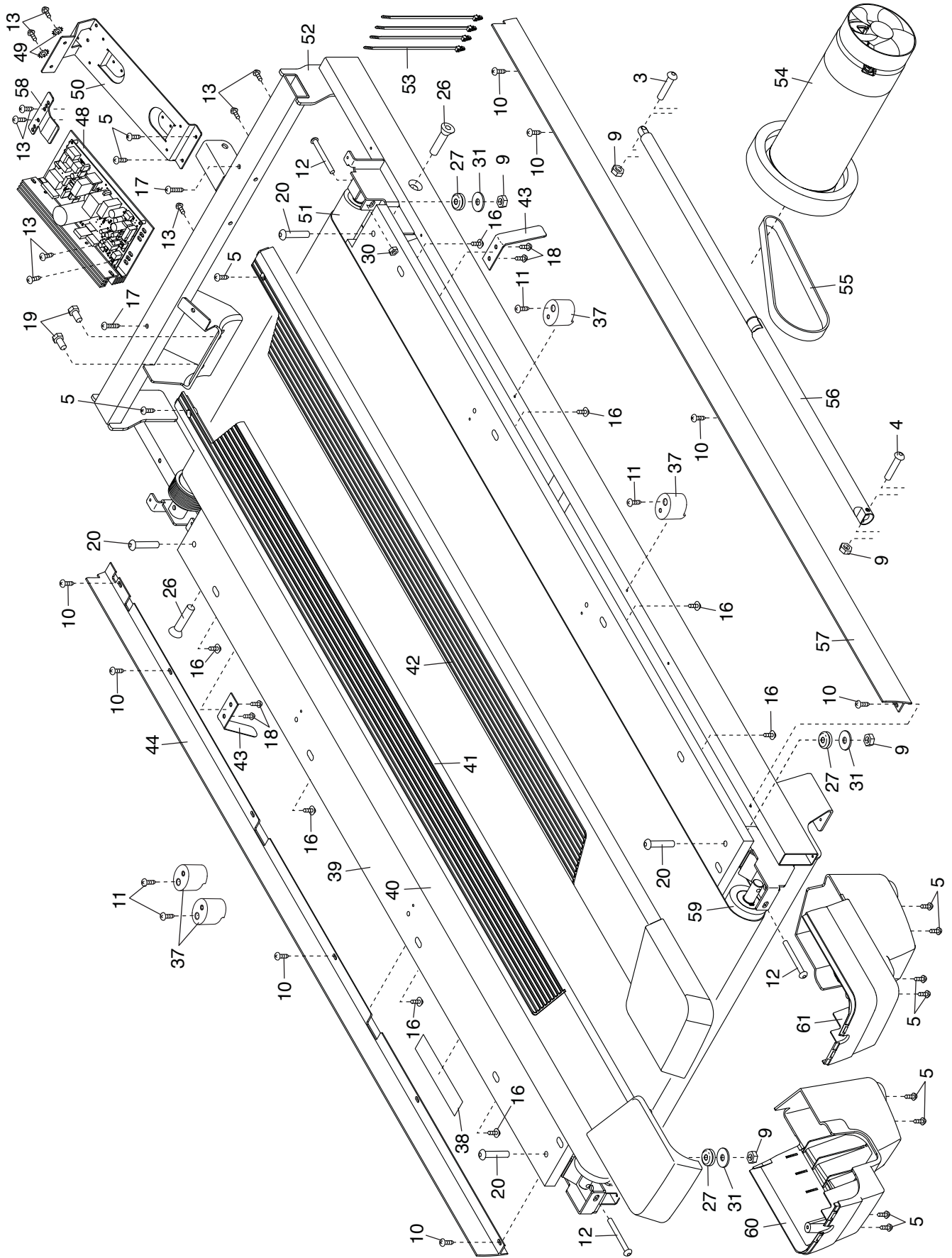

EXPLODED DRAWING B

Model No. PFTL16213.4 R1115A

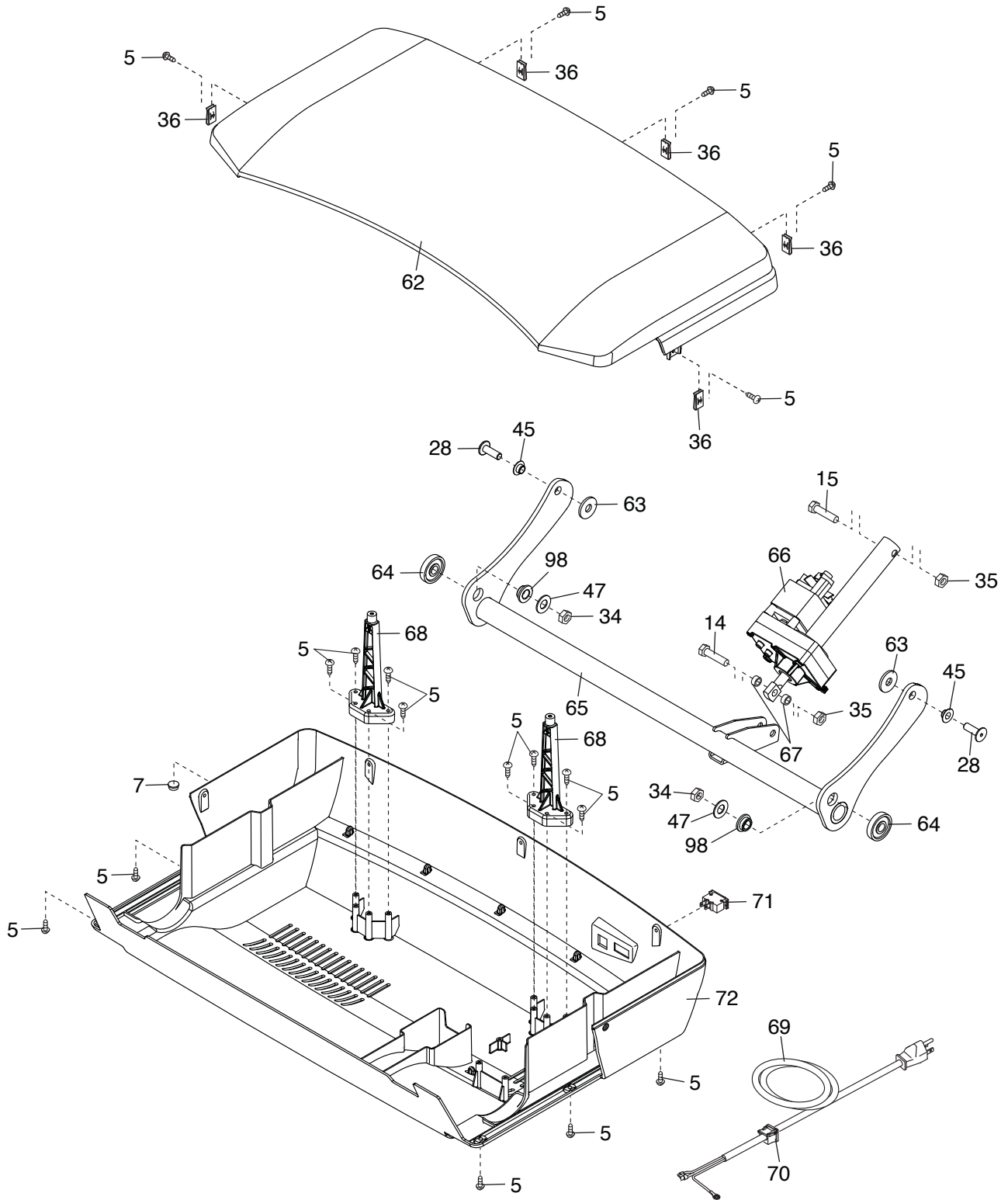

EXPLODED DRAWING C

Model No. PFTL16213.4 R1115A

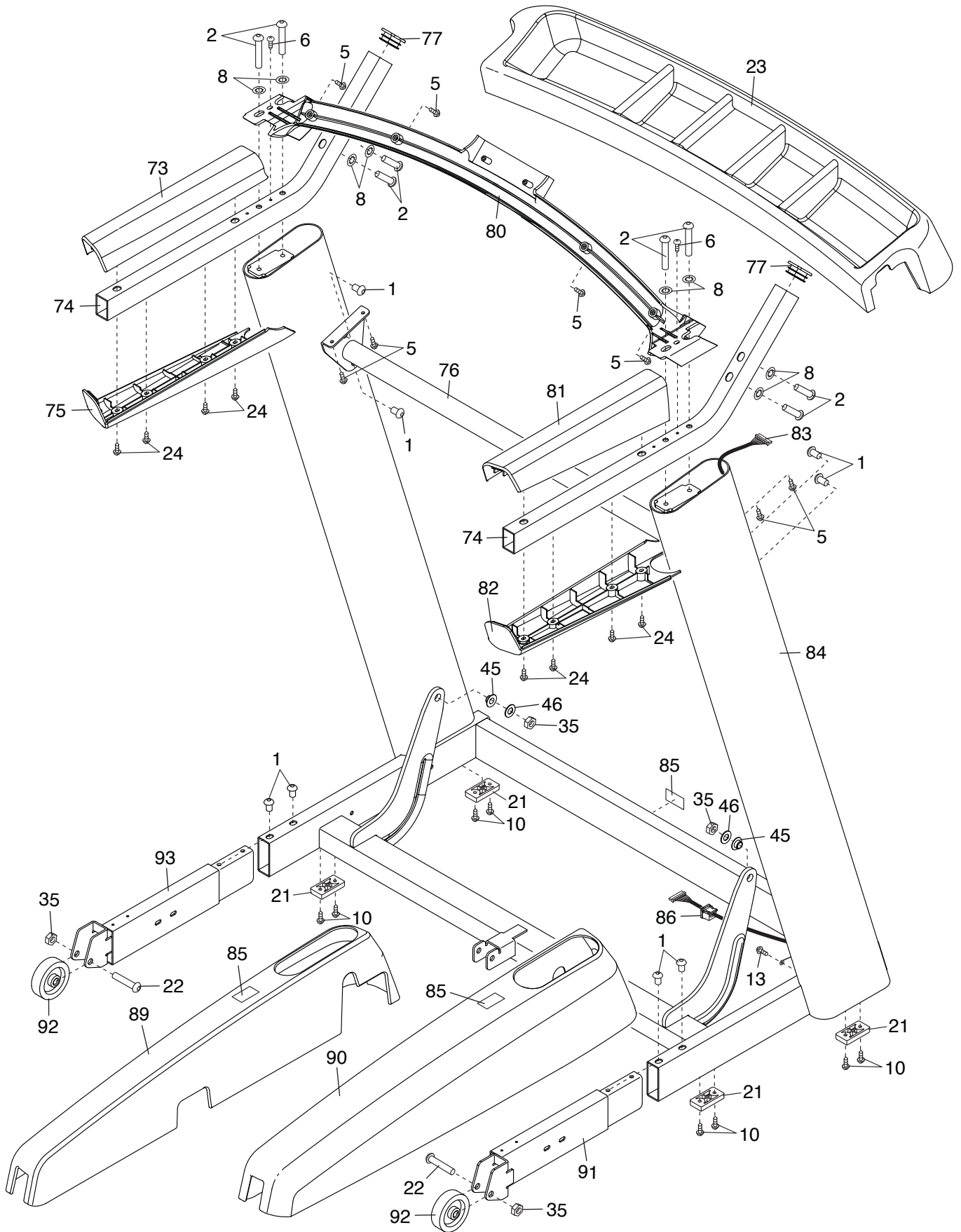

EXPLODED DRAWING D

Model No. PFTL16213.4 R1115A

