

EXPLODED DRAWING B

Model No. PFTL17014.0 R0814A

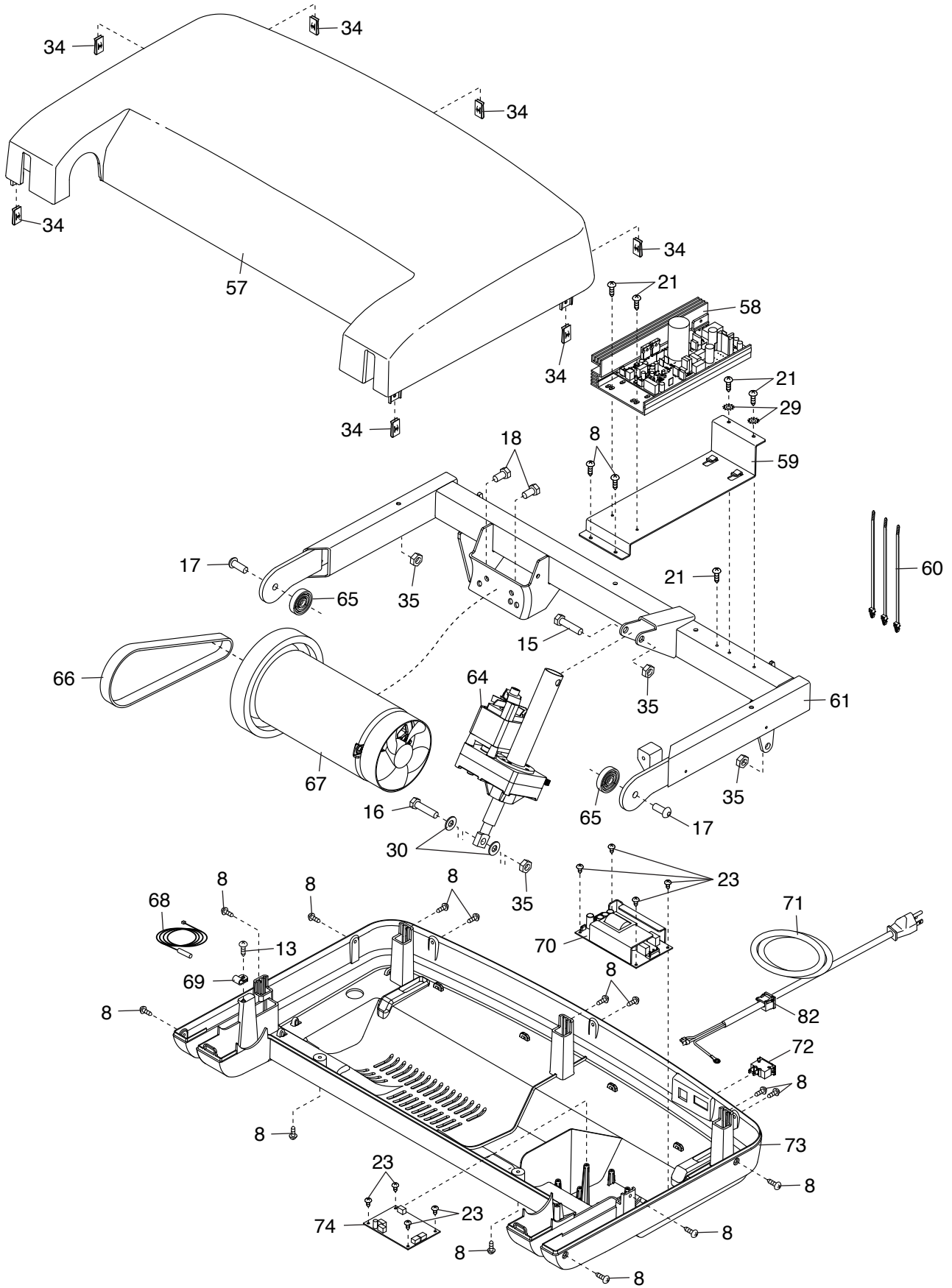

EXPLODED DRAWING C

Model No. PFTL17014.0 R0814A

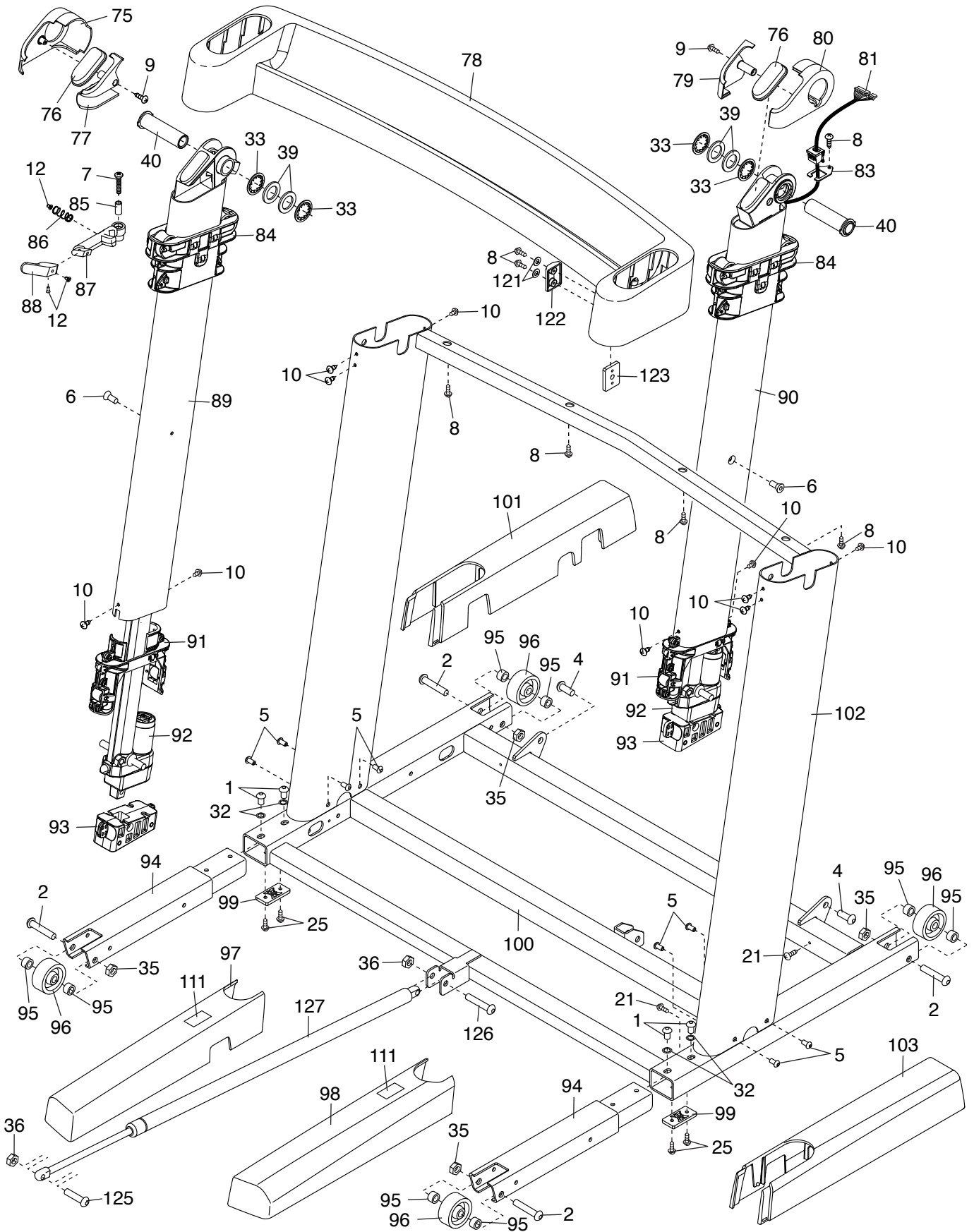

EXPLODED DRAWING D

Model No. PFTL17014.0 R0814A

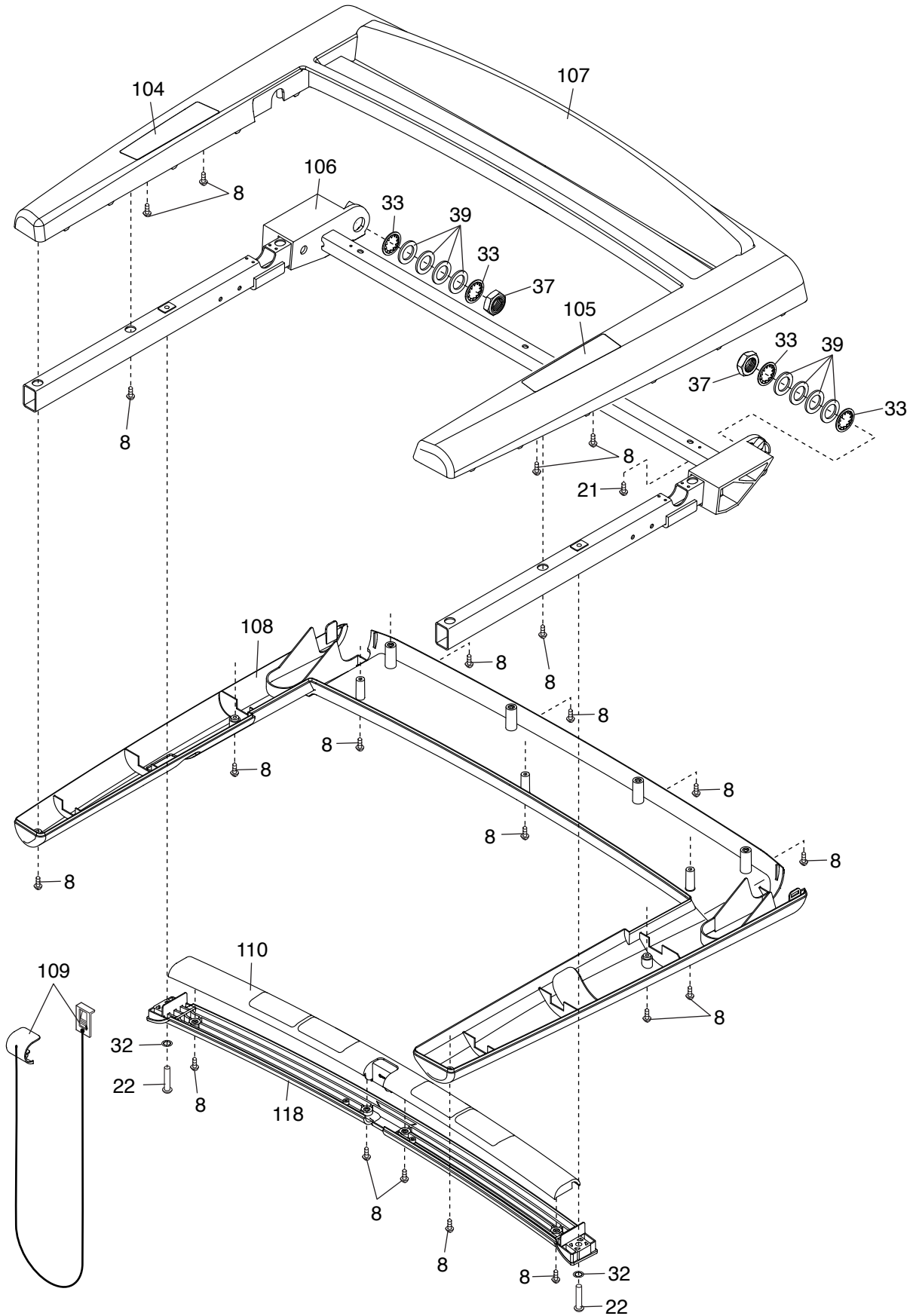

EXPLODED DRAWING E

Model No. PFTL17014.0 R0814A

