

EXPLODED DRAWING A

Model No. PFTL17116.2 R1017A

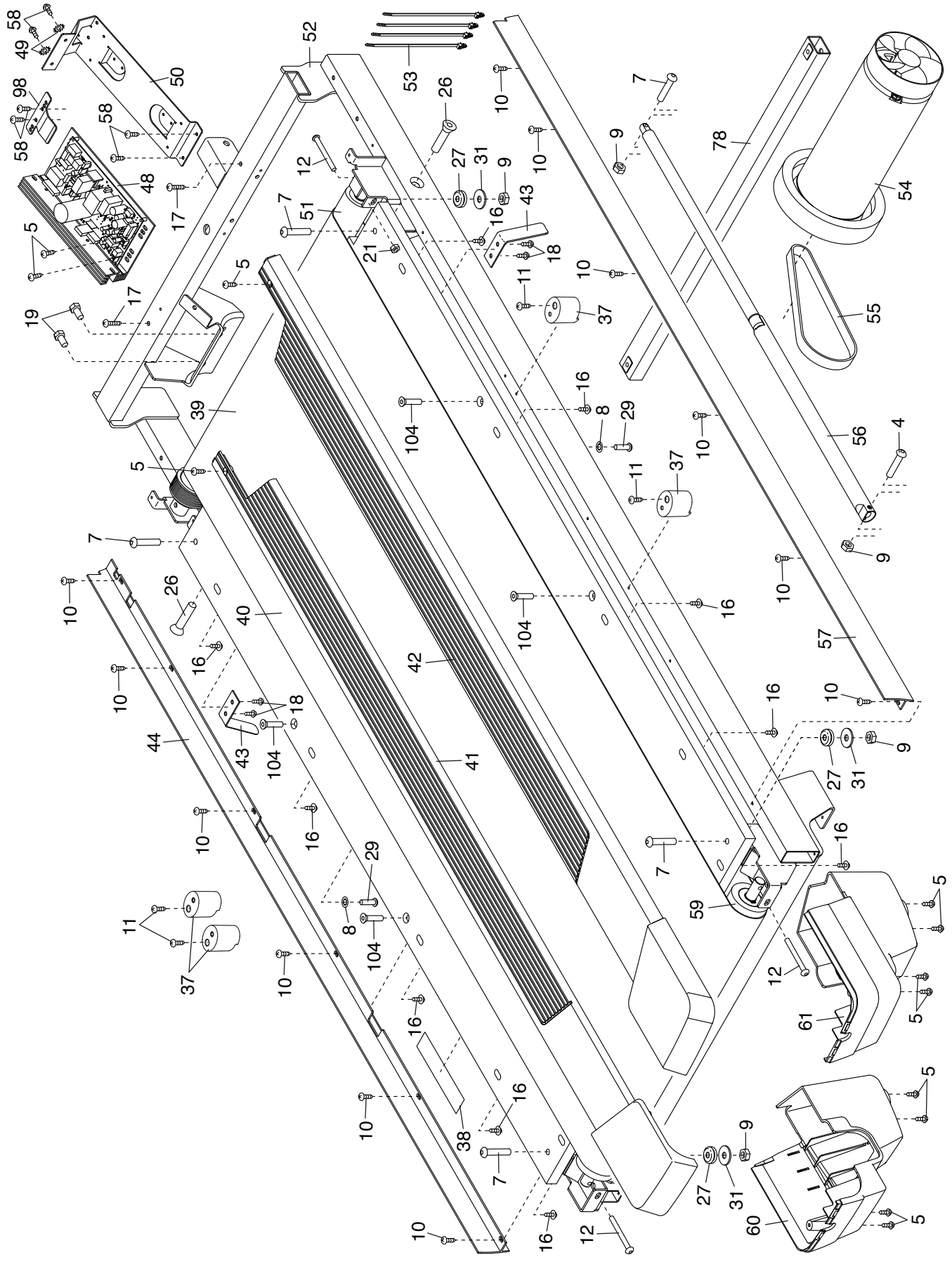

40

EXPLODED DRAWING B

Model No. PFTL17116.2 R1017A

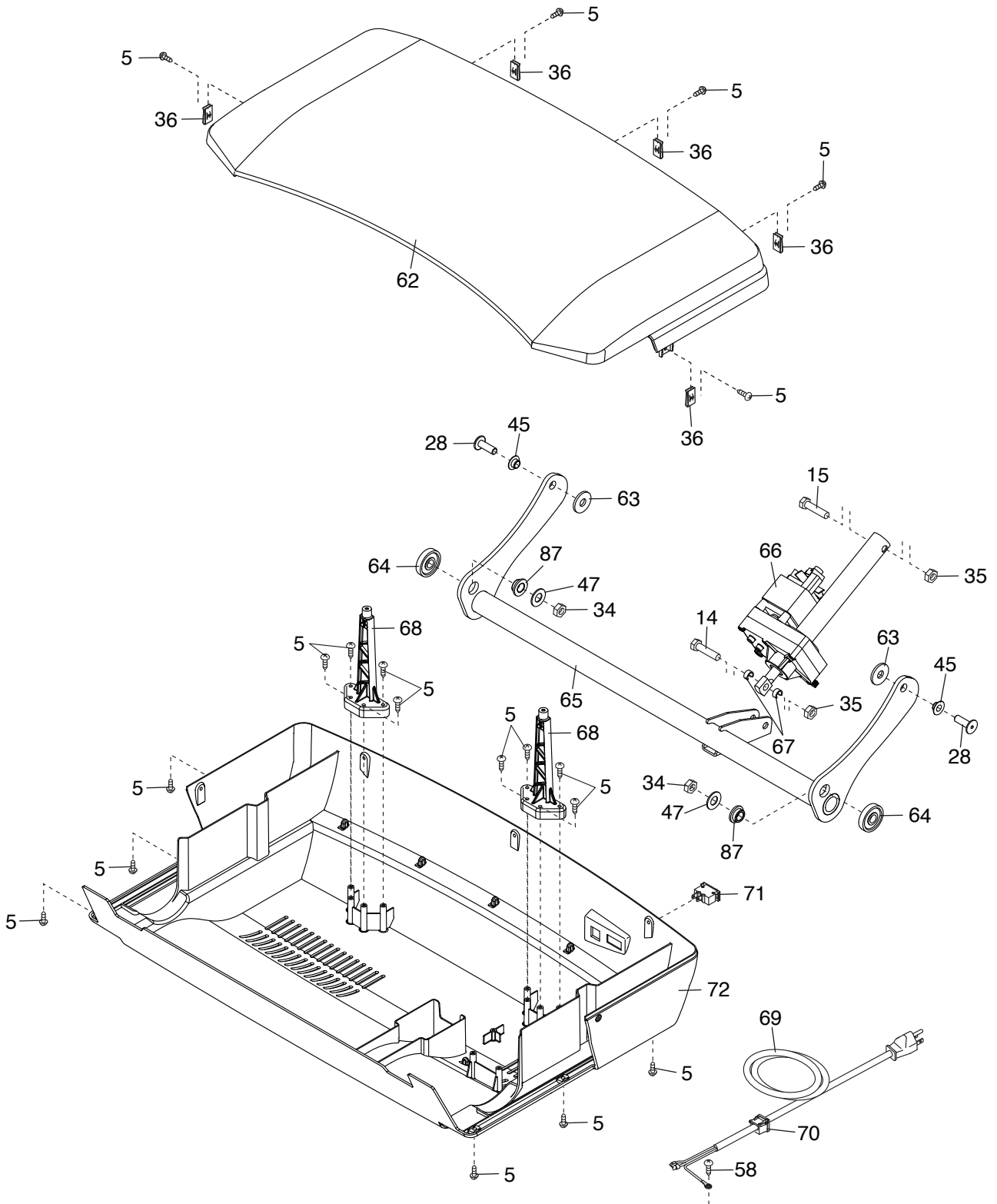

EXPLODED DRAWING C

Model No. PFTL17116.2 R1017A

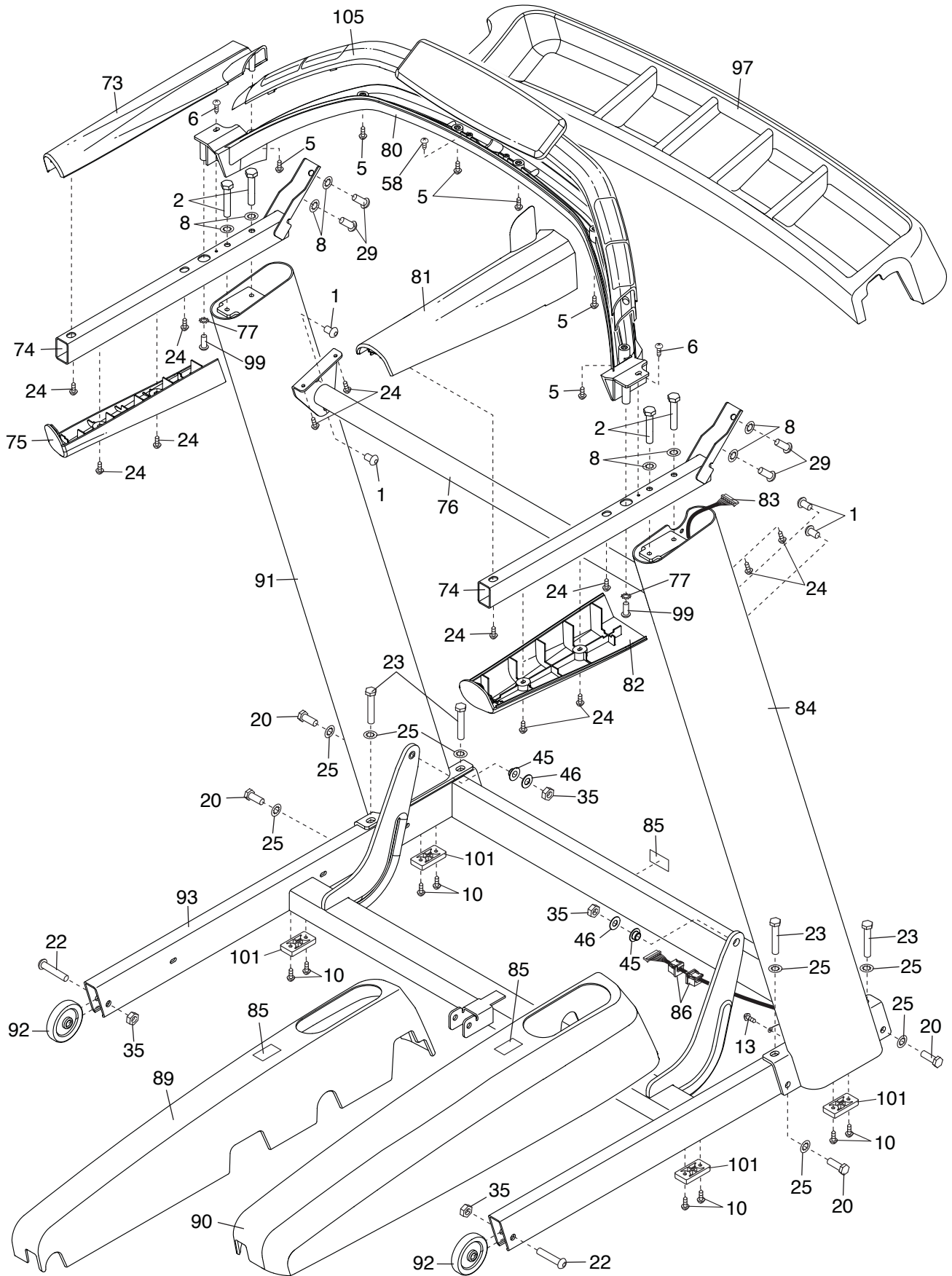

EXPLODED DRAWING D

Model No. PFTL17116.2 R1017A

