

EXPLODED DRAWING A

Model No. PFTL19214.2 R0416A

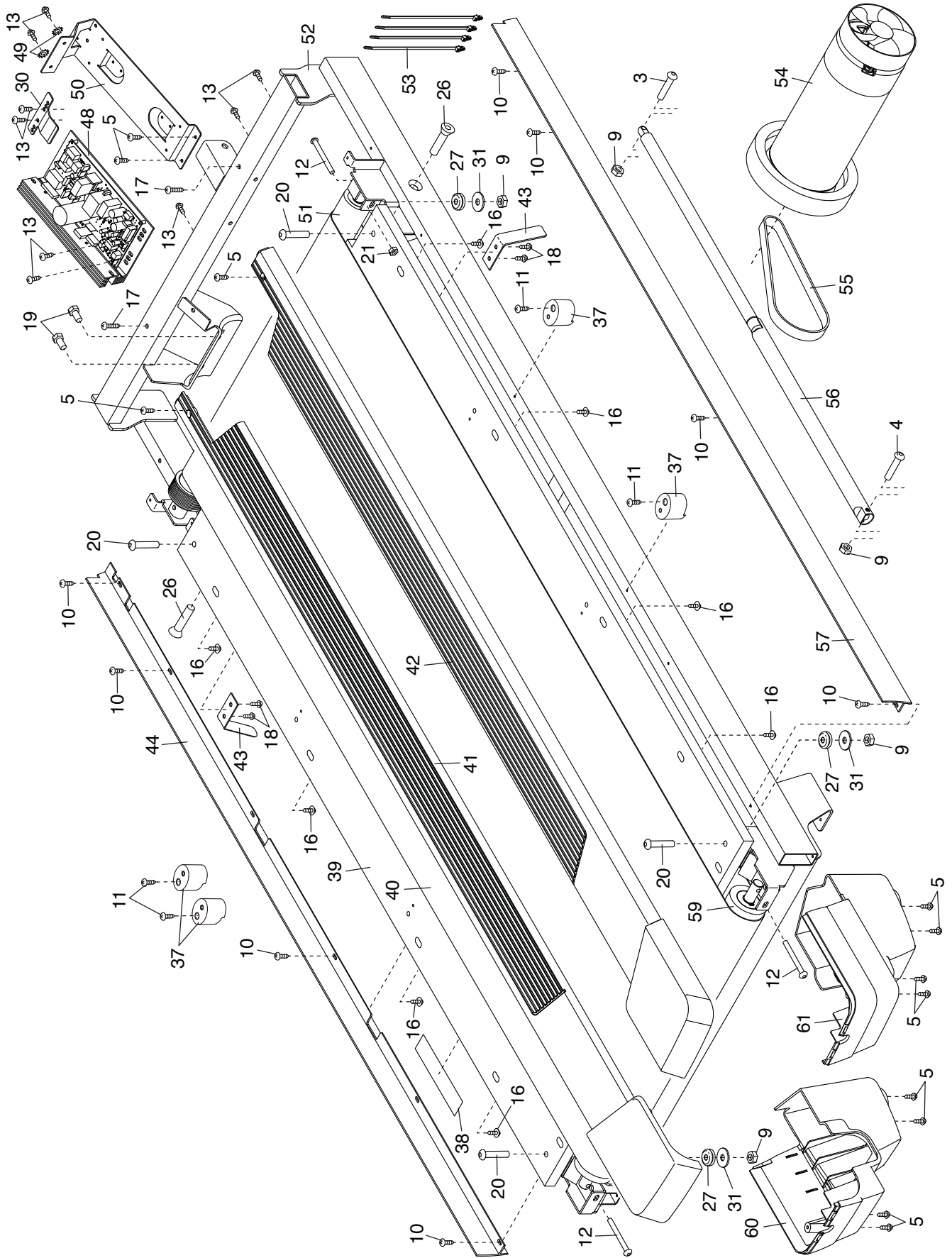

EXPLODED DRAWING C

Model No. PFTL19214.2 R0416A

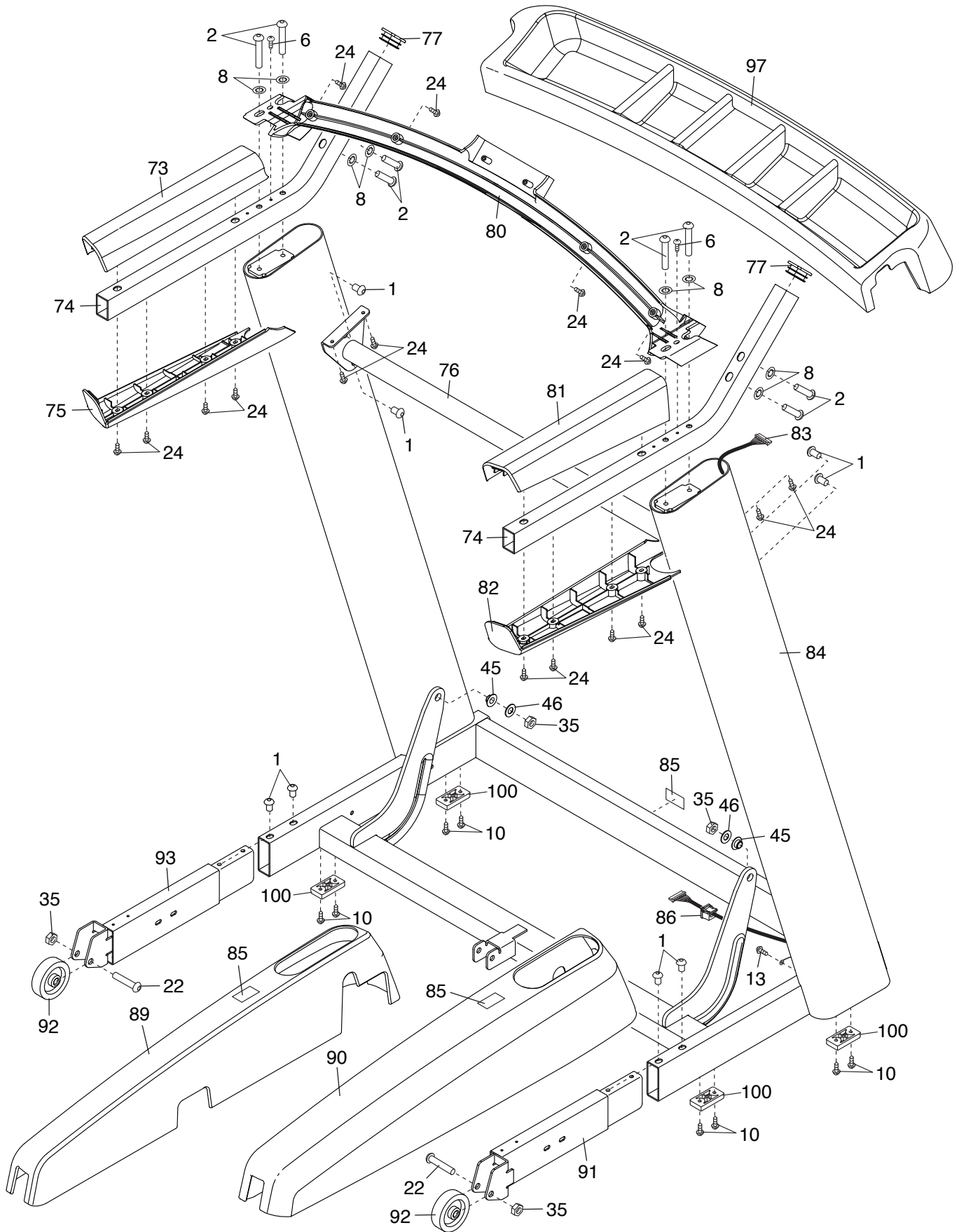

EXPLODED DRAWING D

Model No. PFTL19214.2 R0416A

