

EXPLODED DRAWING A

Model No. PFTL19214.0 R0515A

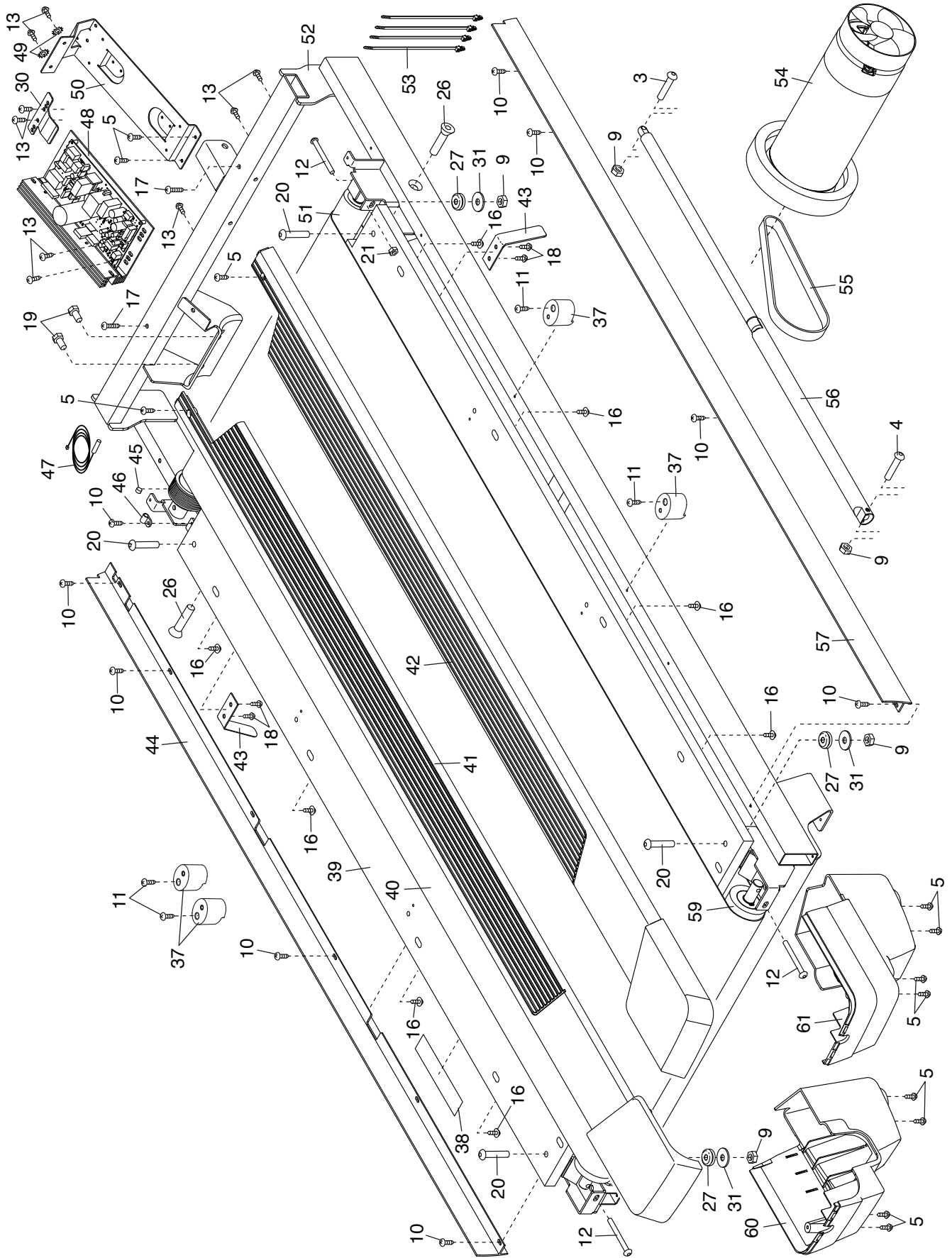

EXPLODED DRAWING B

Model No. PFTL19214.0 R0515A

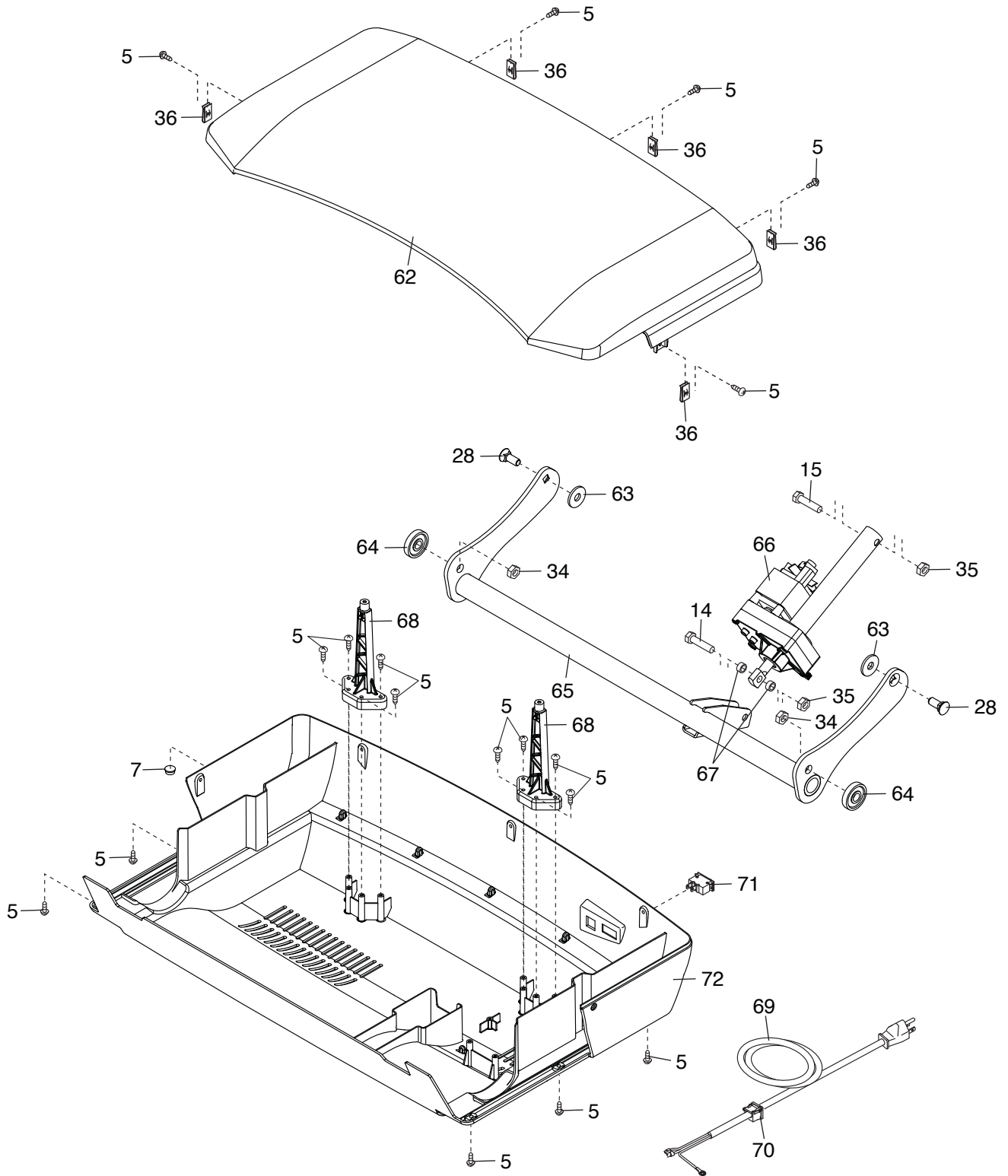

EXPLODED DRAWING C

Model No. PFTL19214.0 R0515A

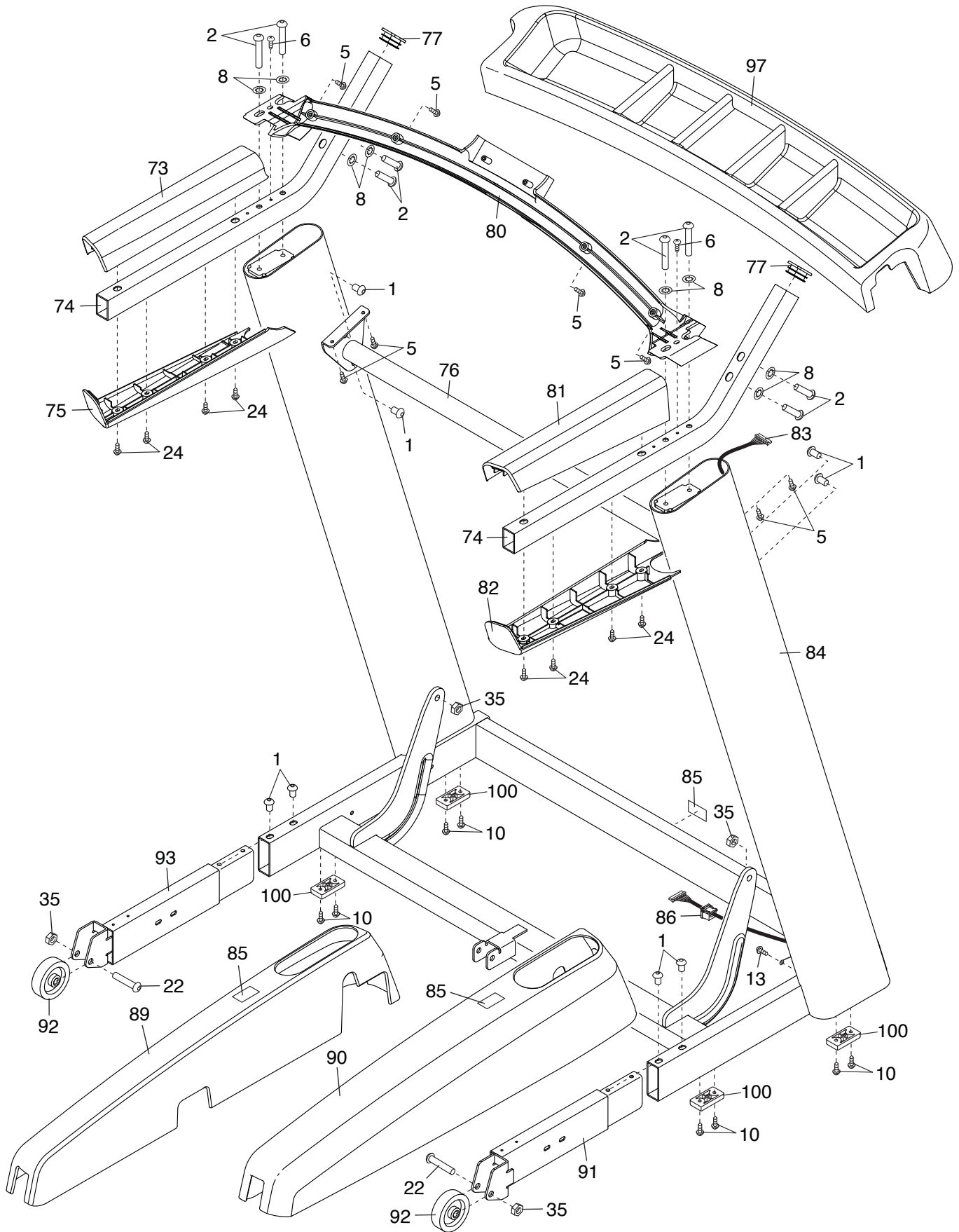

EXPLODED DRAWING D

Model No. PFTL19214.0 R0515A

