

# EXPLODED DRAWING A

Model No. PFTL20012.2 R1013A

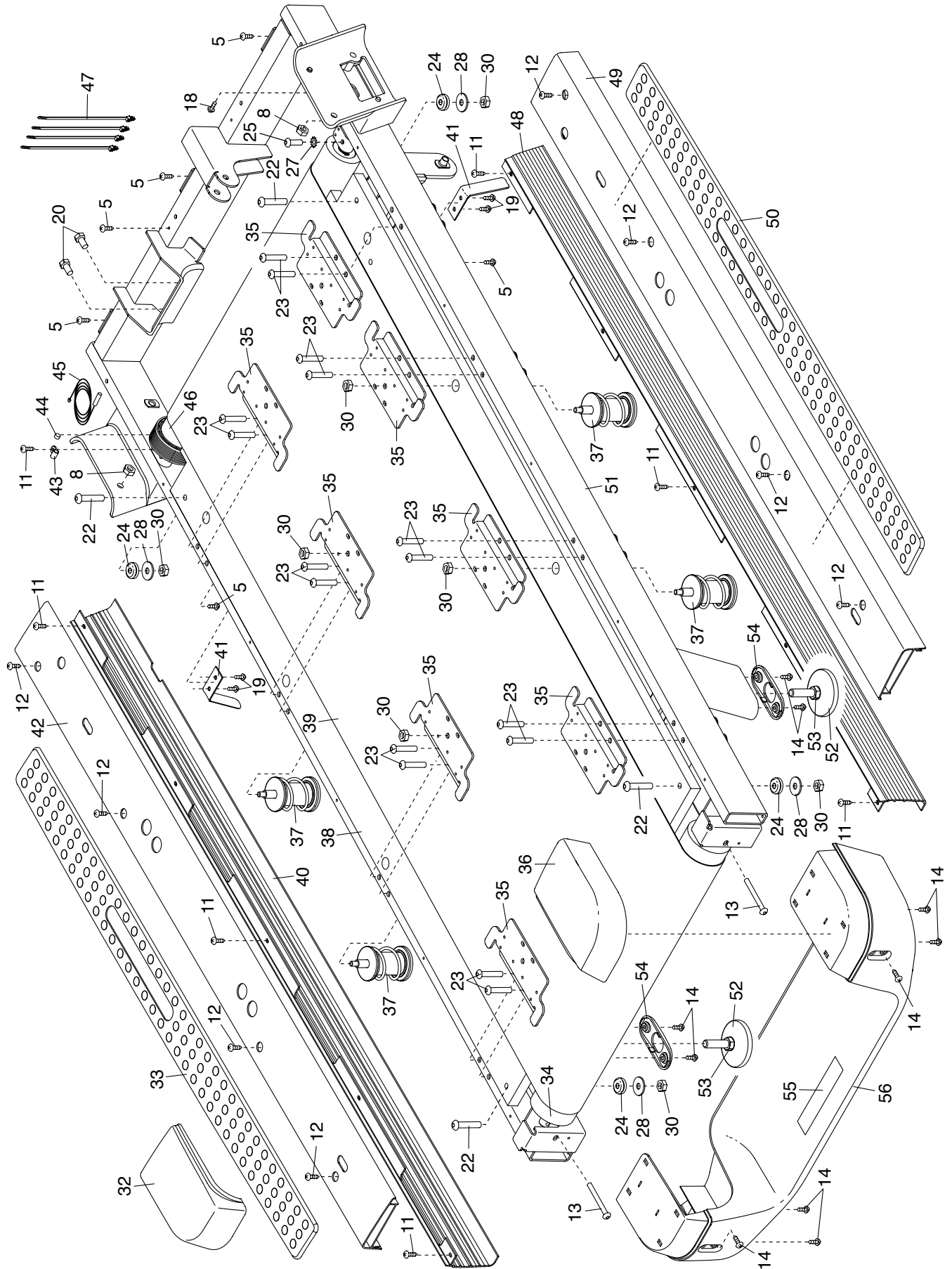

# EXPLODED DRAWING B

Model No. PFTL20012.2 R1013A

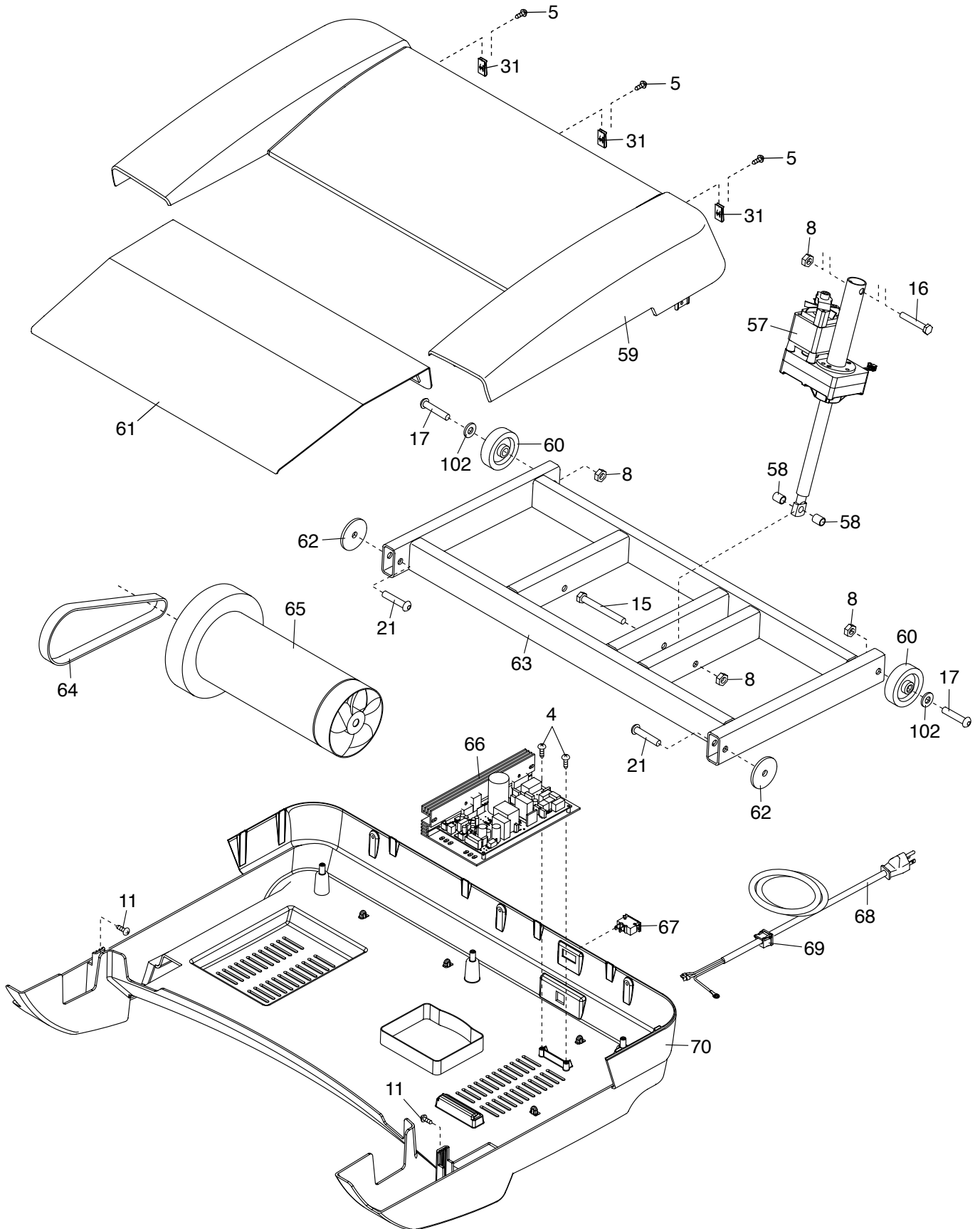

# EXPLODED DRAWING C

Model No. PFTL20012.2 R1013A

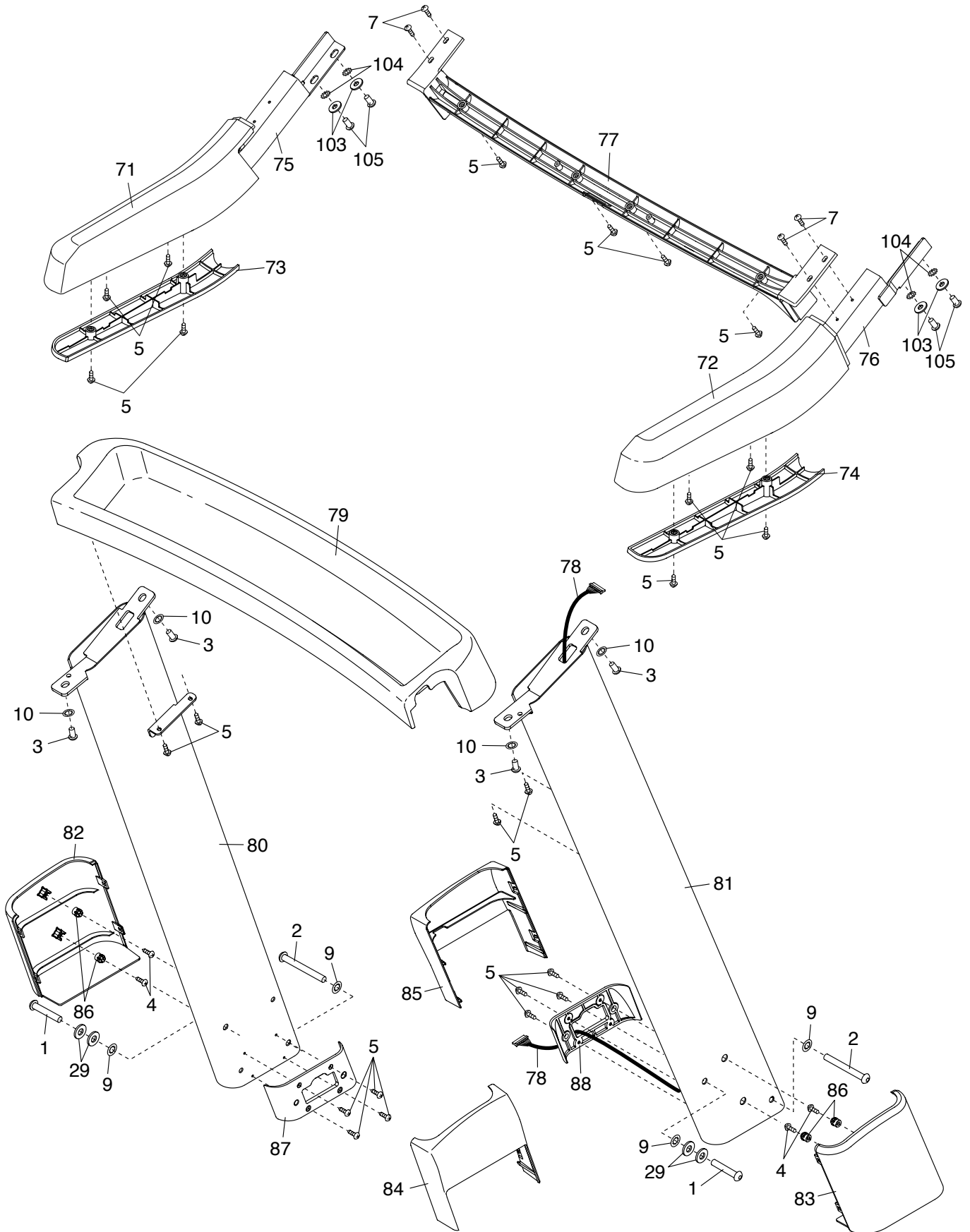

# EXPLODED DRAWING D

Model No. PFTL20012.2 R1013A

