

EXPLODED DRAWING A

Model No. PFTL20511.1 R0213A

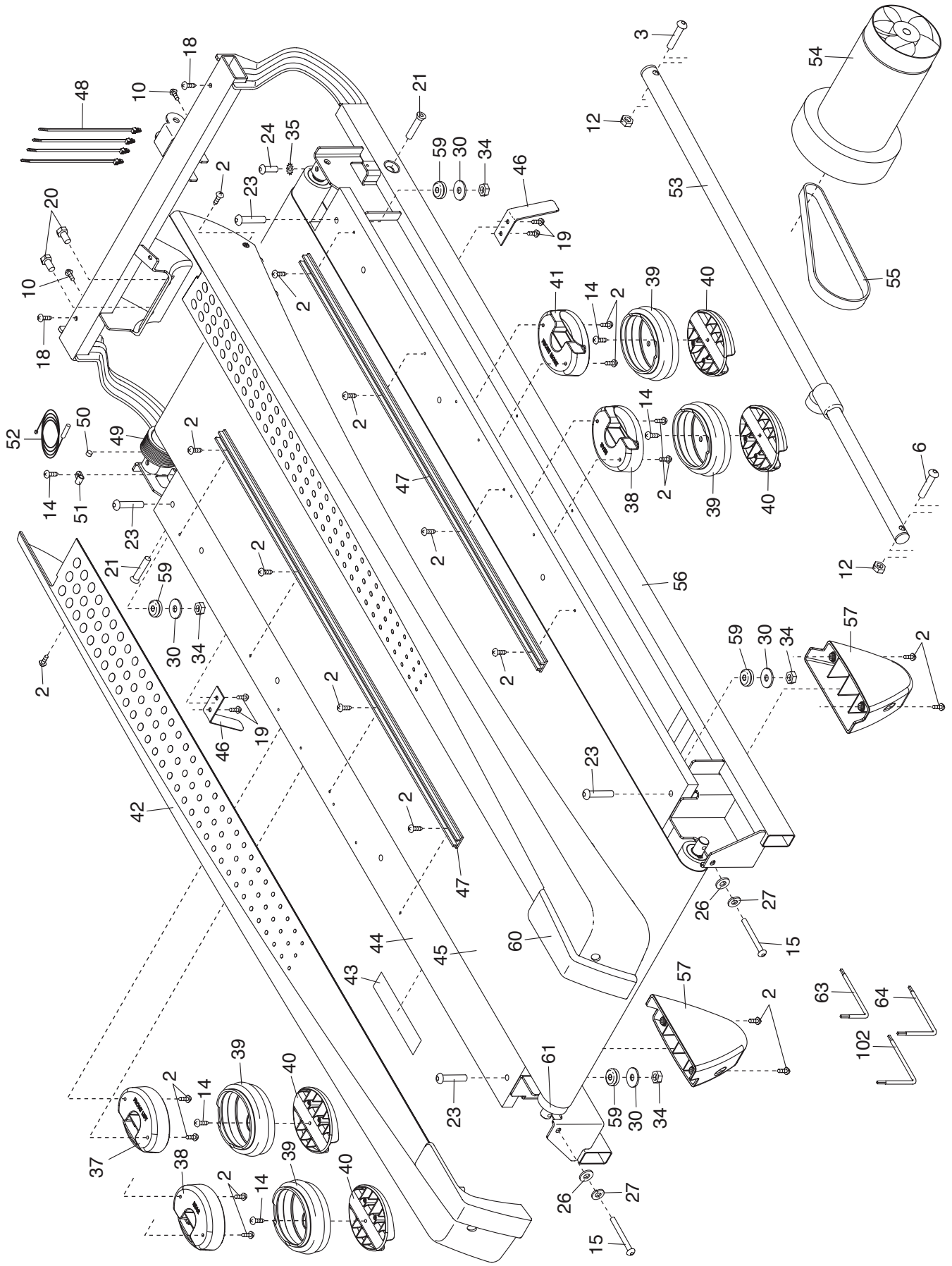

EXPLODED DRAWING C

Model No. PFTL20511.1 R0213A

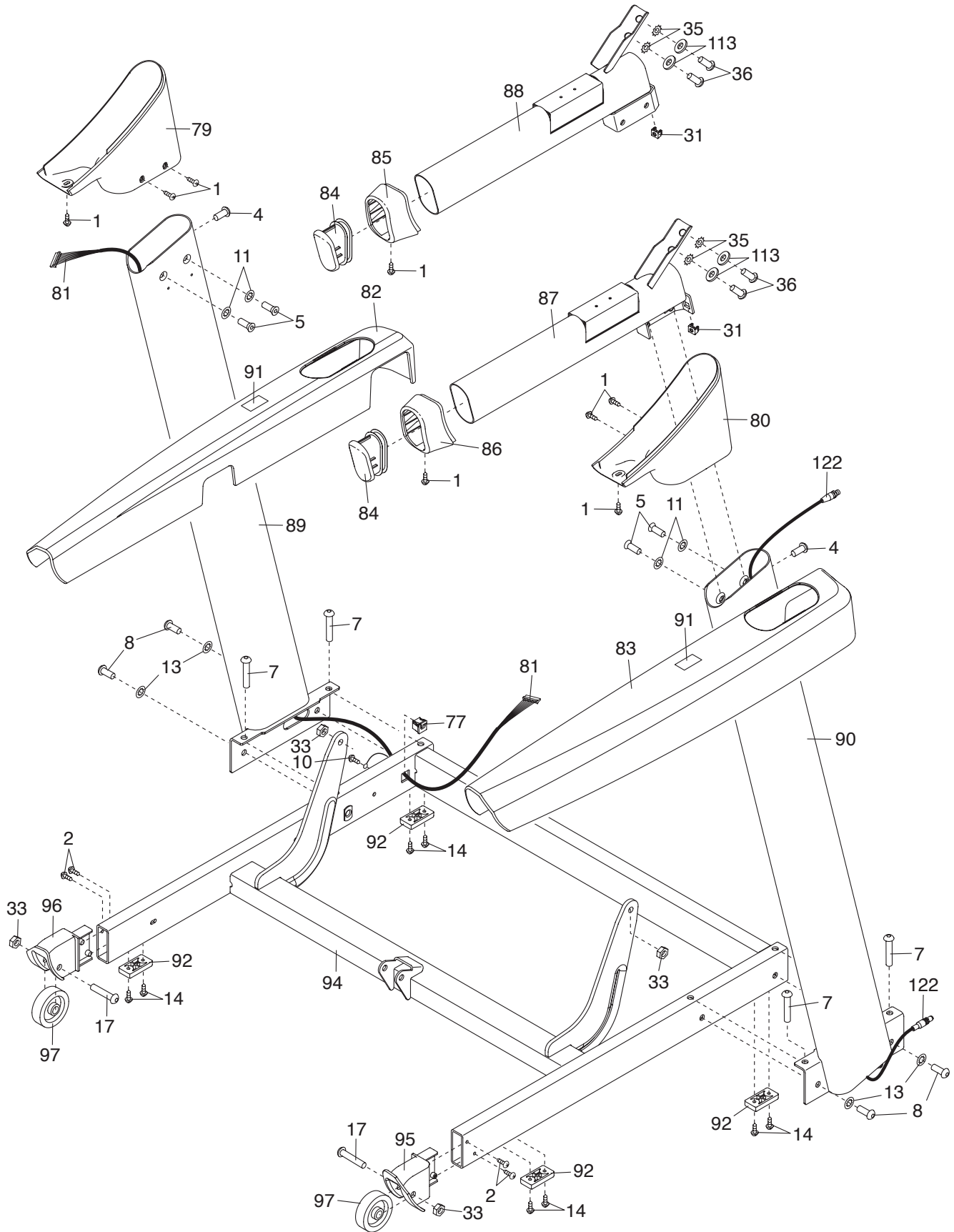

EXPLODED DRAWING D

Model No. PFTL20511.1 R0213A

