

EXPLODED DRAWING A

Model No. PFTL20511.5 R0515A

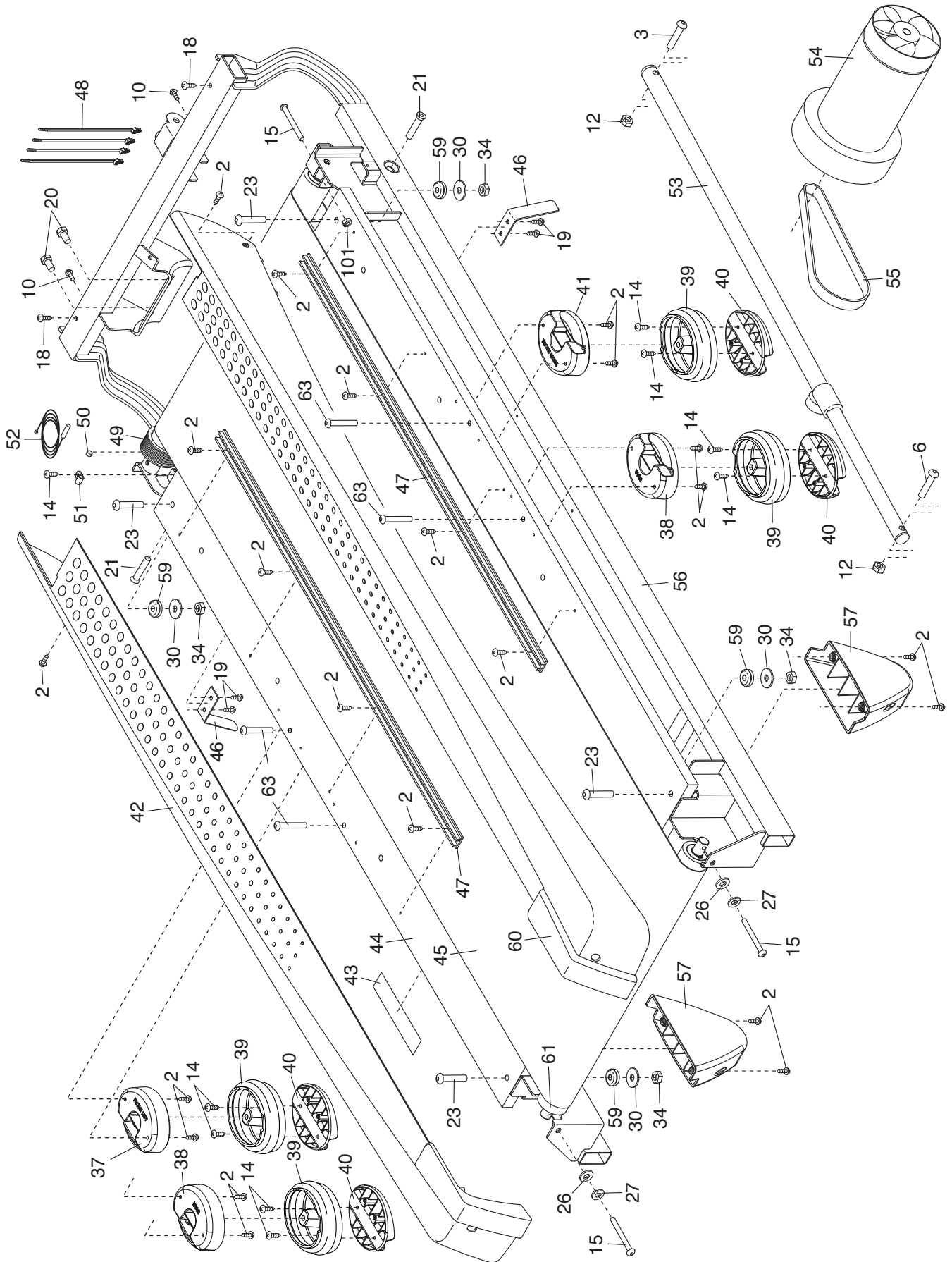

EXPLODED DRAWING C

Model No. PFTL20511.5 R0515A

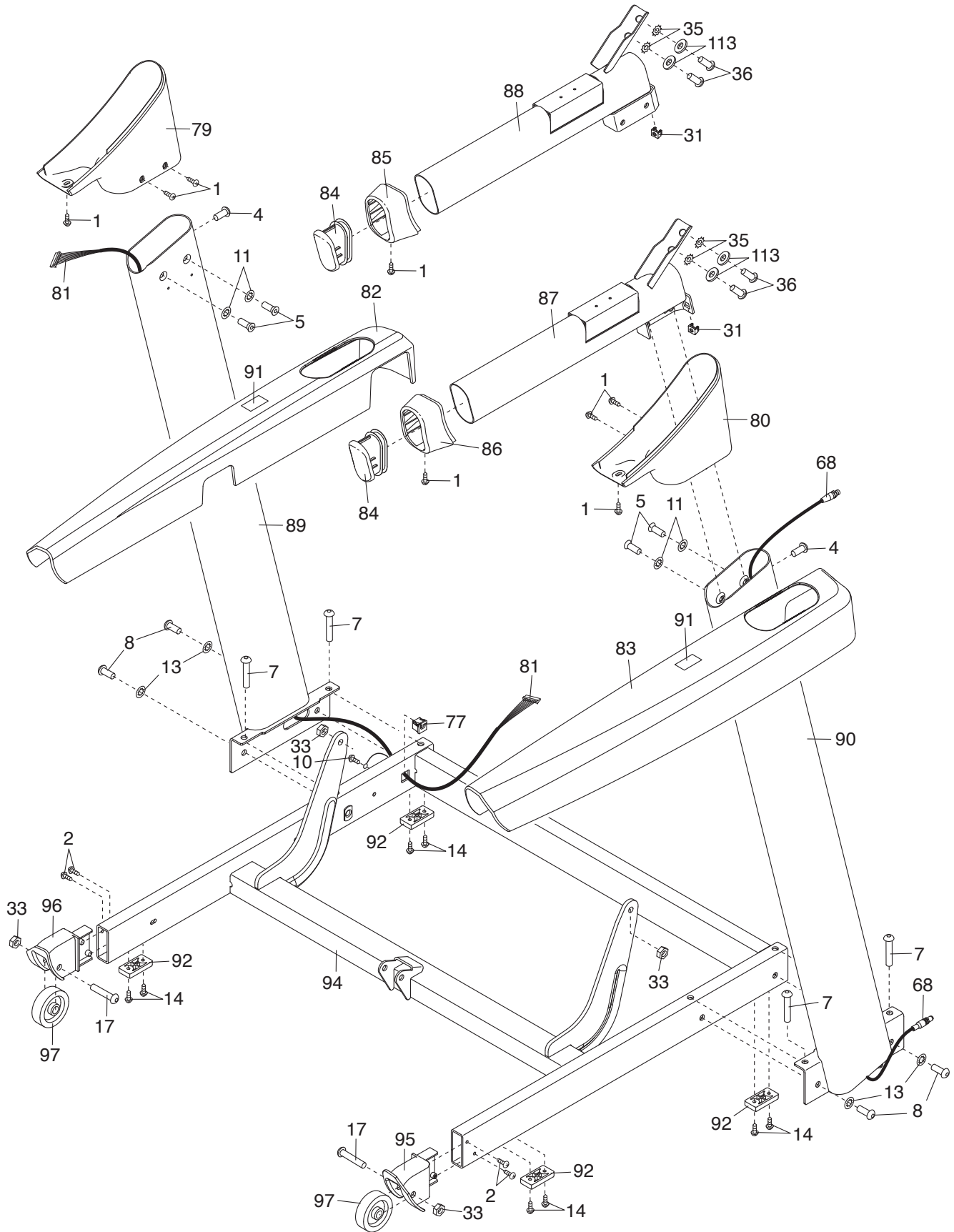

EXPLODED DRAWING D

Model No. PFTL20511.5 R0515A

