

# EXPLODED DRAWING A

Model No. PFTL21012.1 R0913A

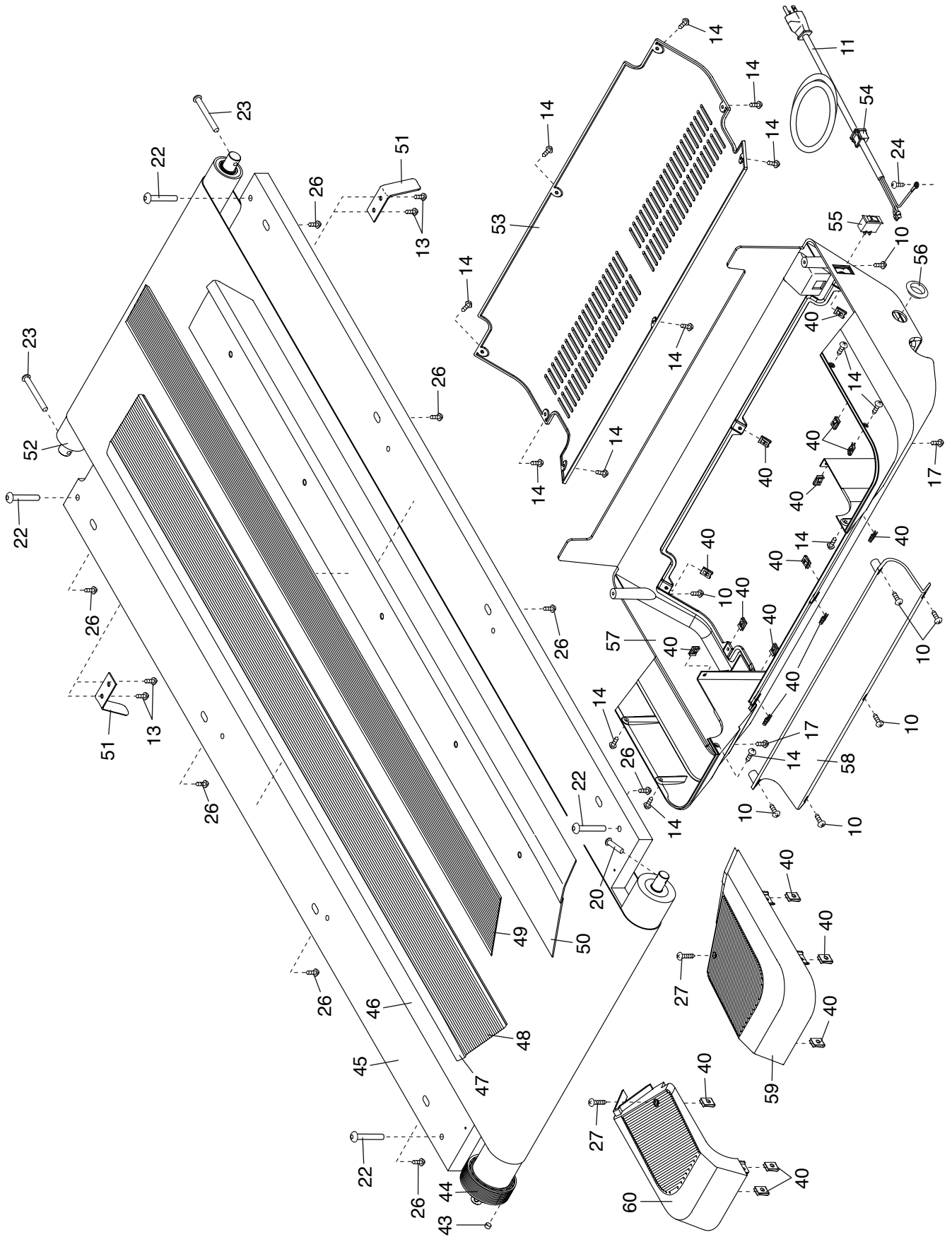

# EXPLODED DRAWING B

Model No. PFTL21012.1 R0913A

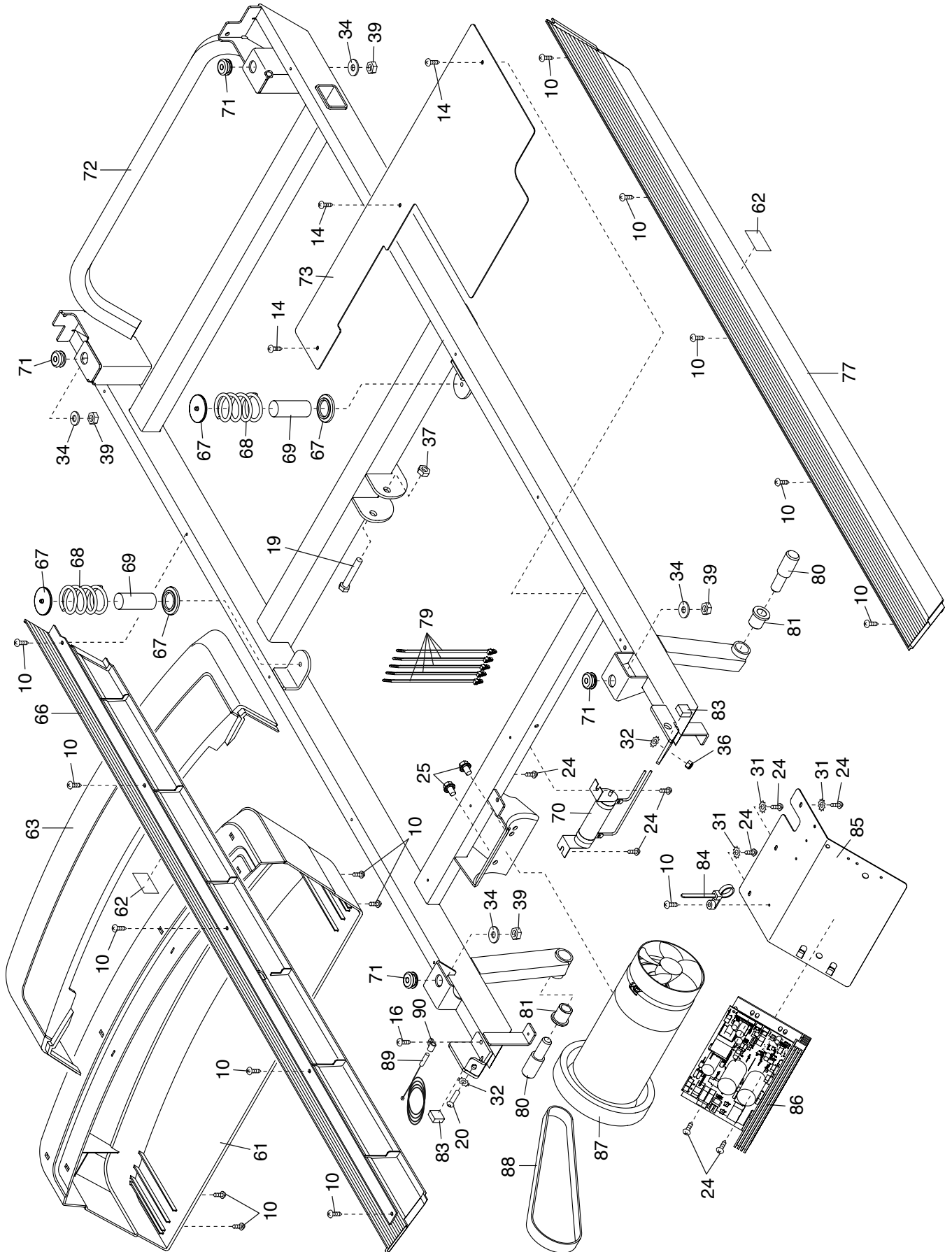

# EXPLODED DRAWING C

Model No. PFTL21012.1 R0913A

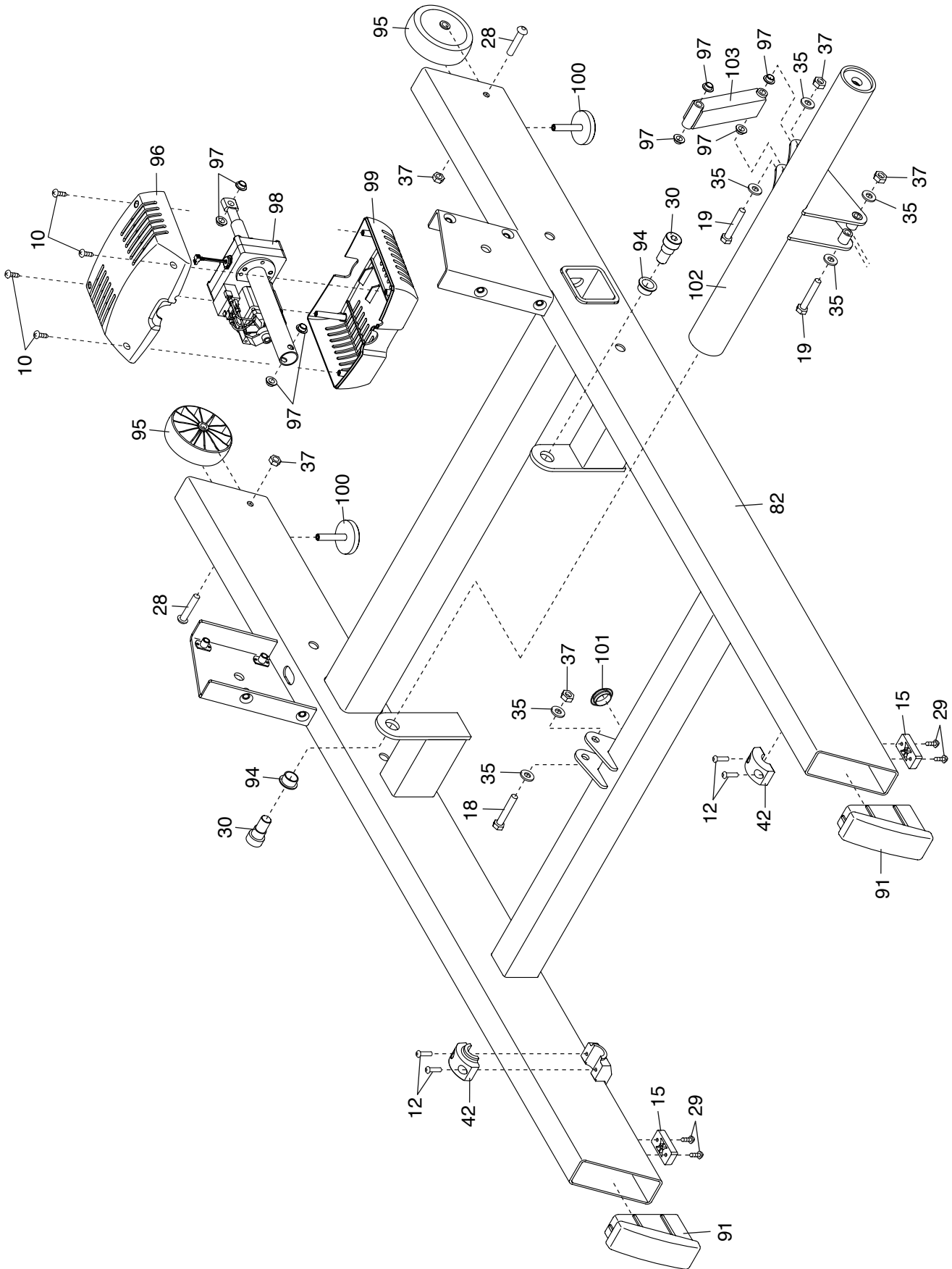

# EXPLODED DRAWING D

Model No. PFTL21012.1 R0913A

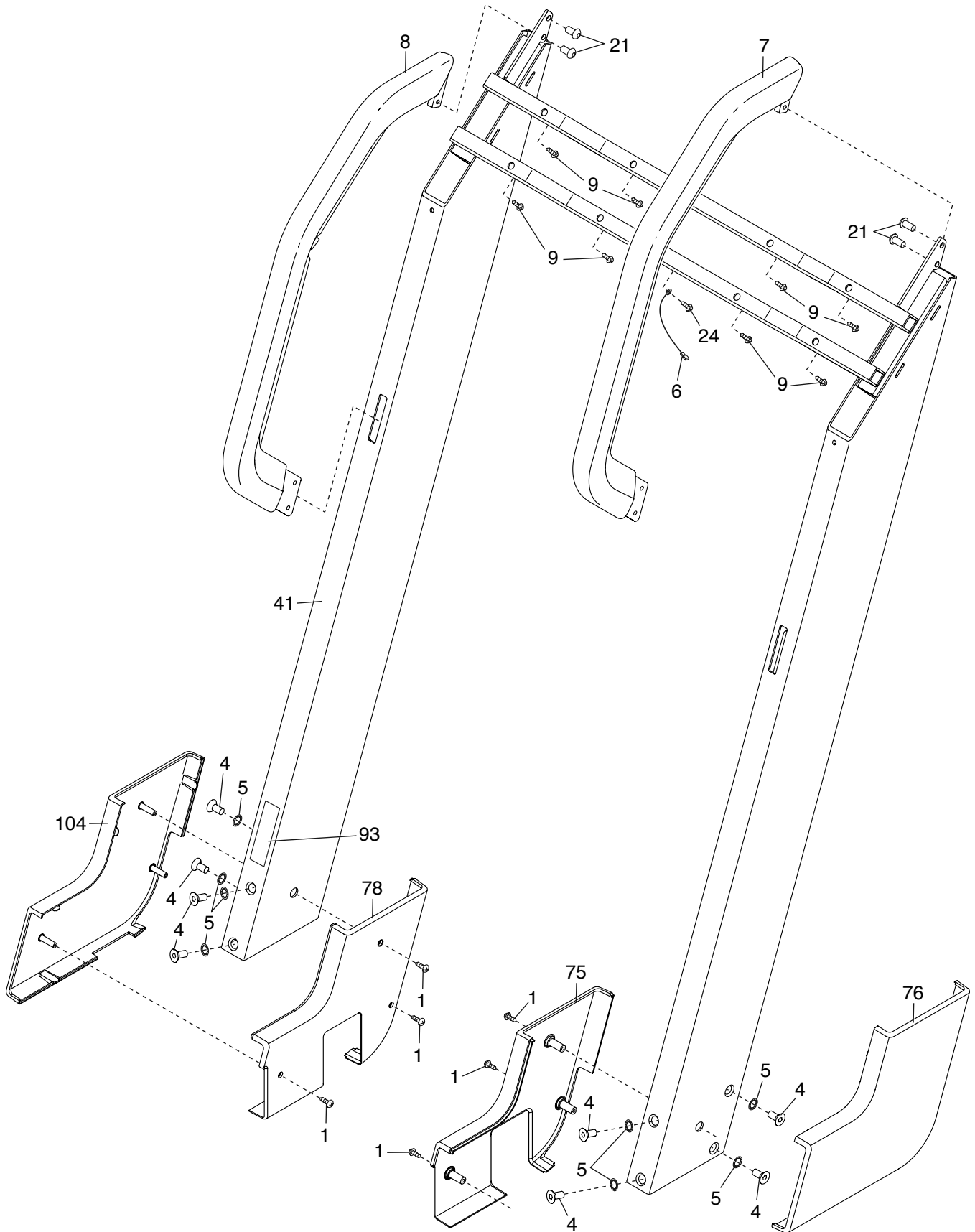

# EXPLODED DRAWING E

Model No. PFTL21012.1 R0913A

