

# EXPLODED DRAWING A

Model No. PFTL39115.0 R0615A

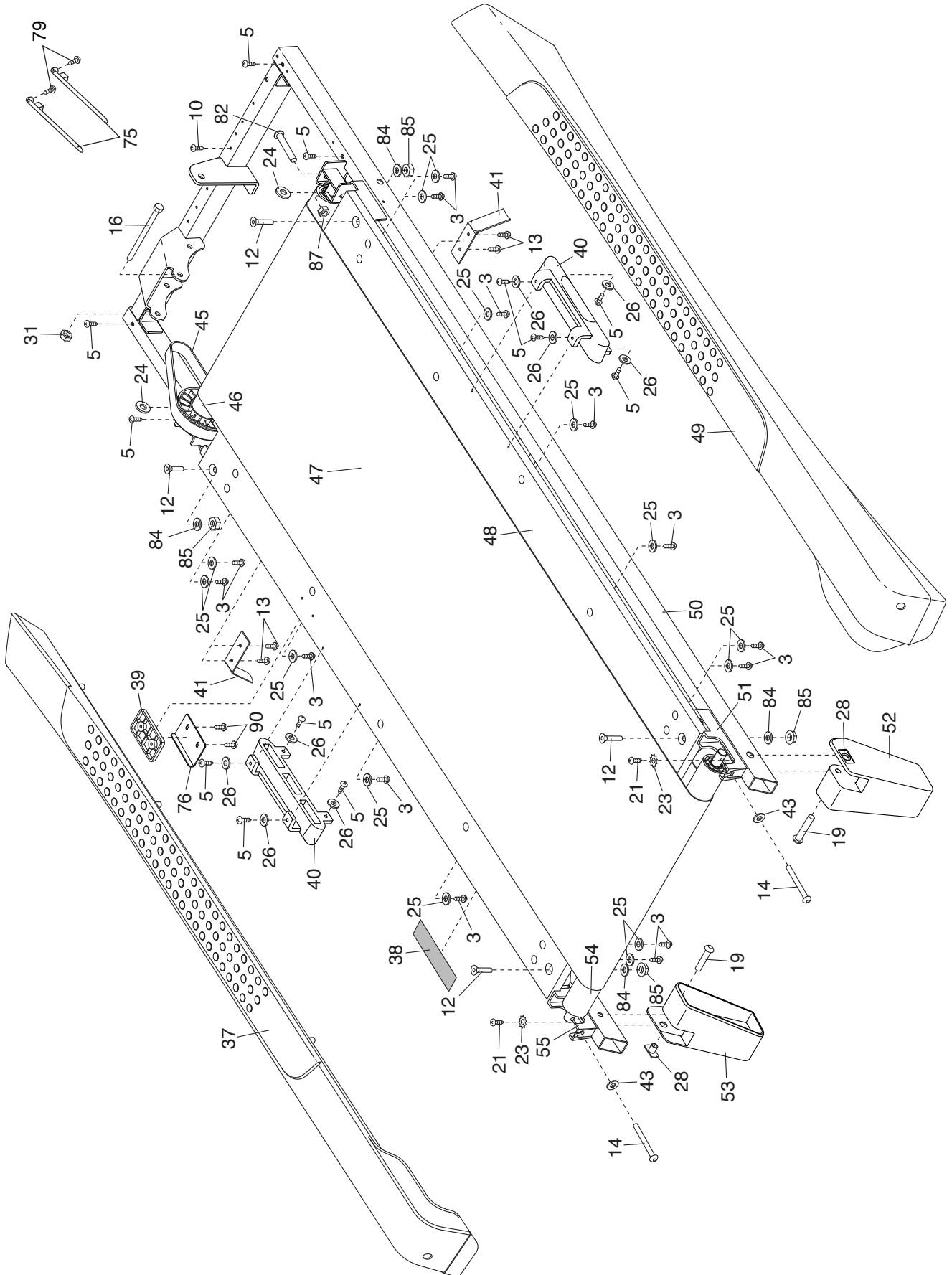

# EXPLODED DRAWING B

Model No. PFTL39115.0 R0615A

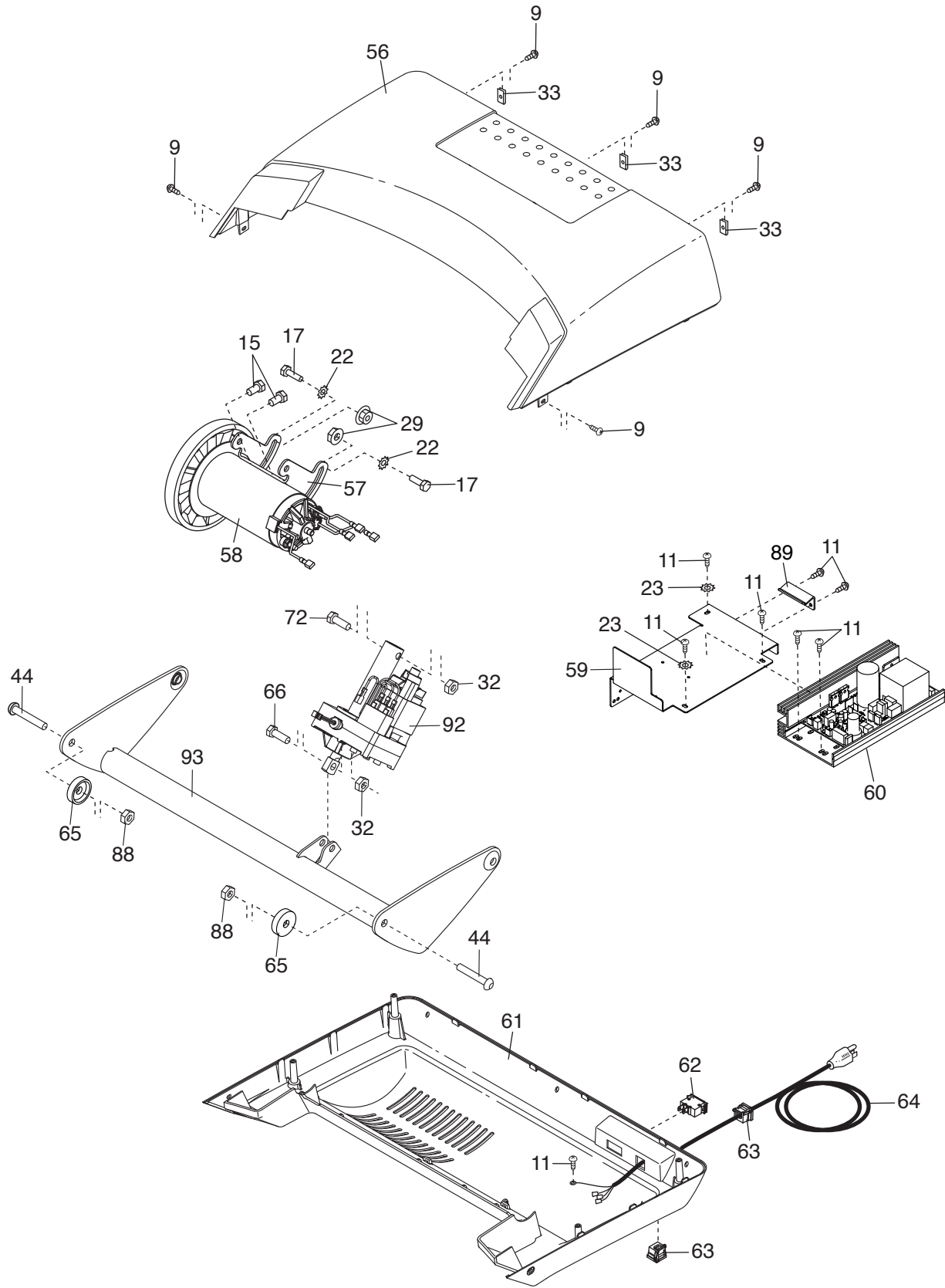

# EXPLODED DRAWING C

Model No. PFTL39115.0 R0615A

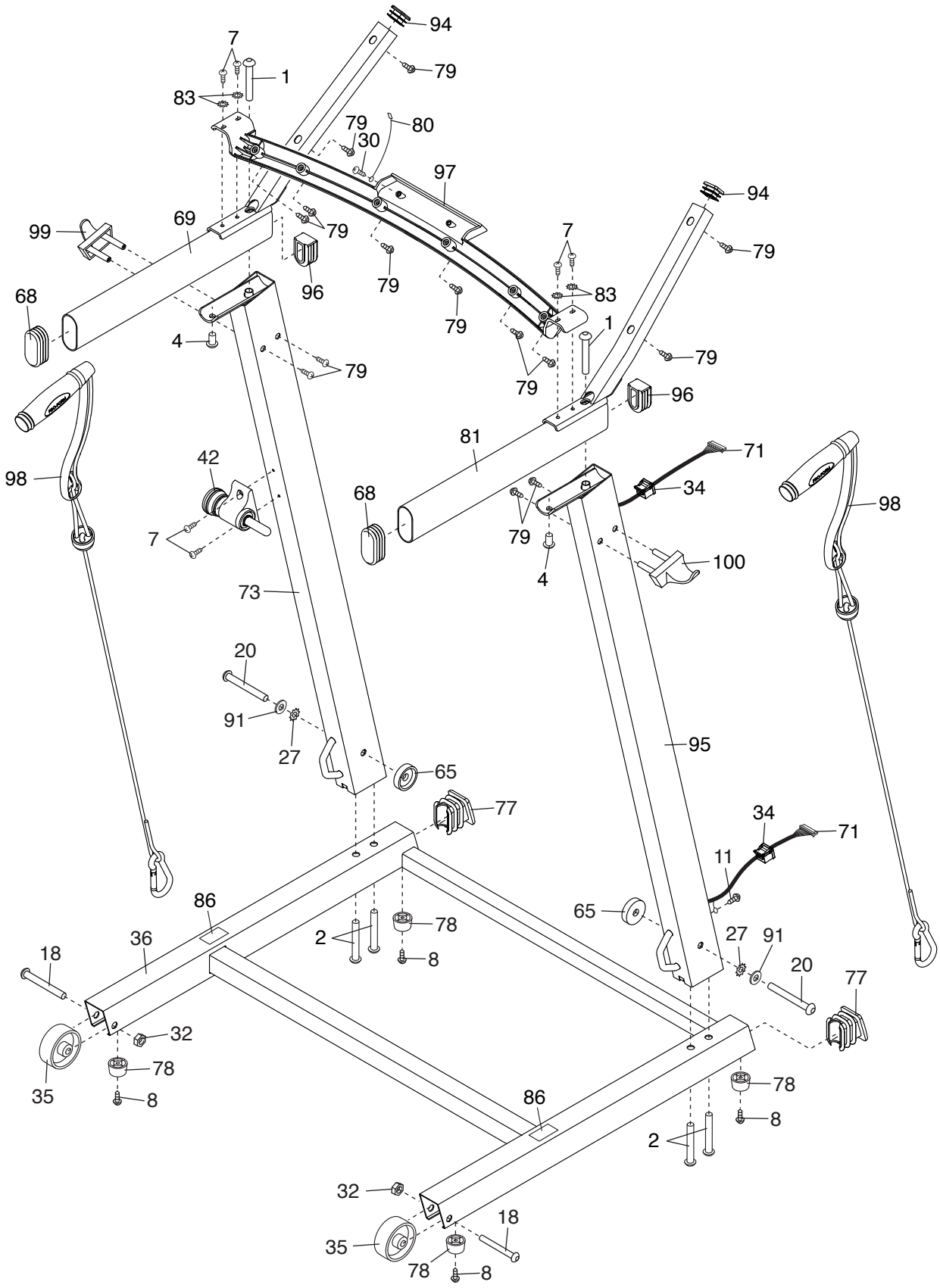

# EXPLODED DRAWING D

Model No. PFTL39115.0 R0615A

