

EXPLODED DRAWING A—Model No. PFTL39507.0

R0607A

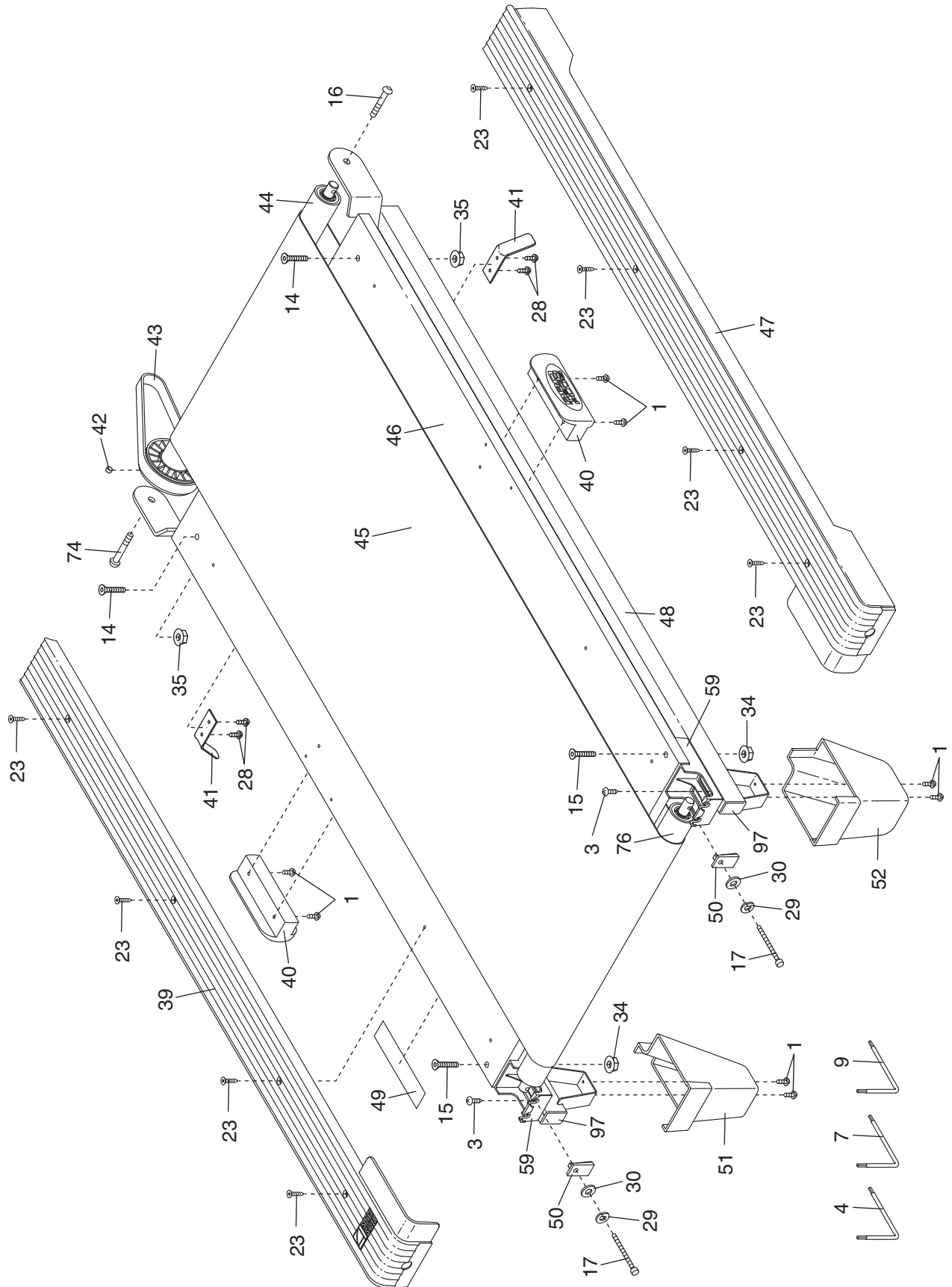

EXPLODED DRAWING B—Model No. PFTL39507.0

R0607A

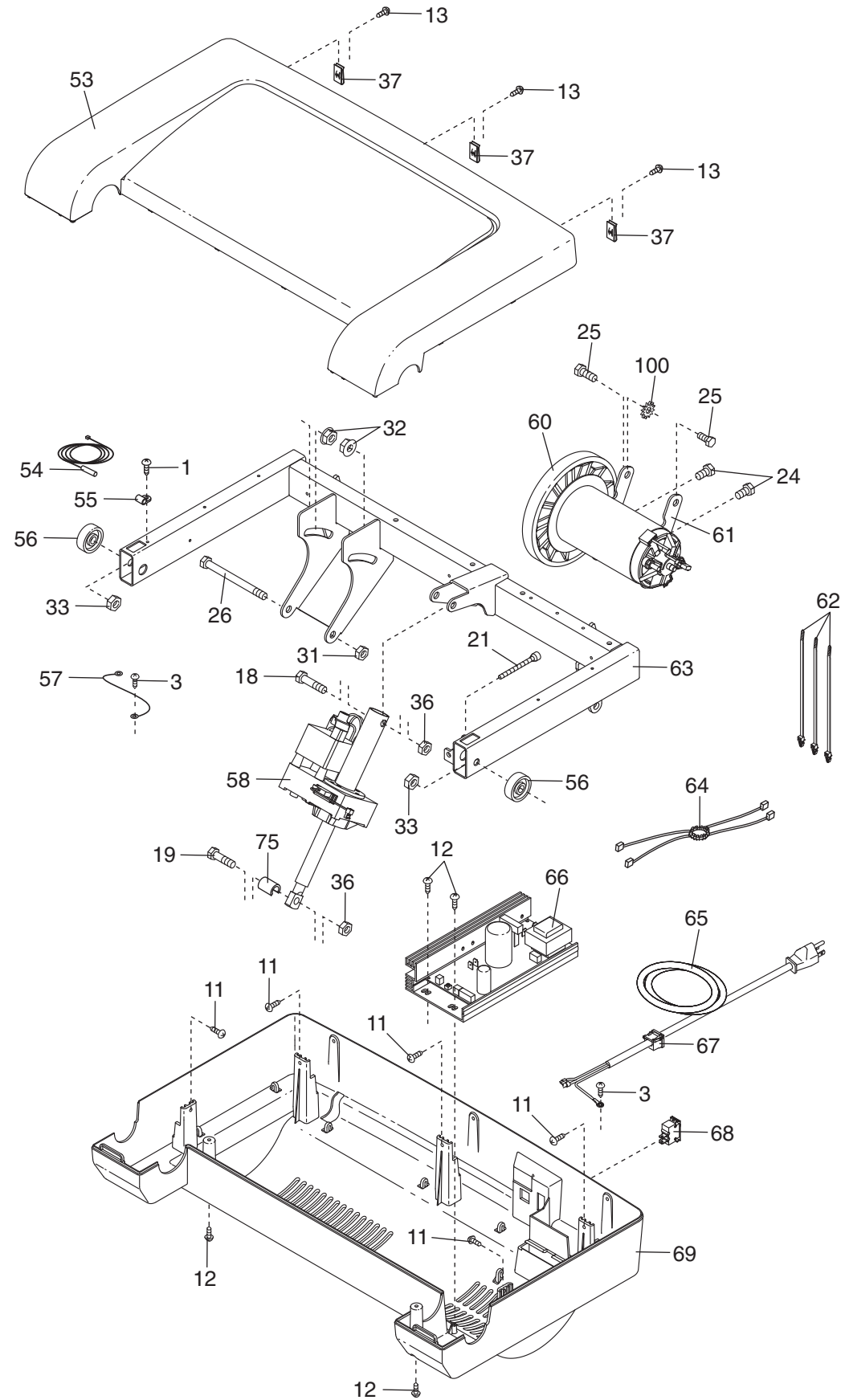

EXPLODED DRAWING C—Model No. PFTL39507.0

R0607A

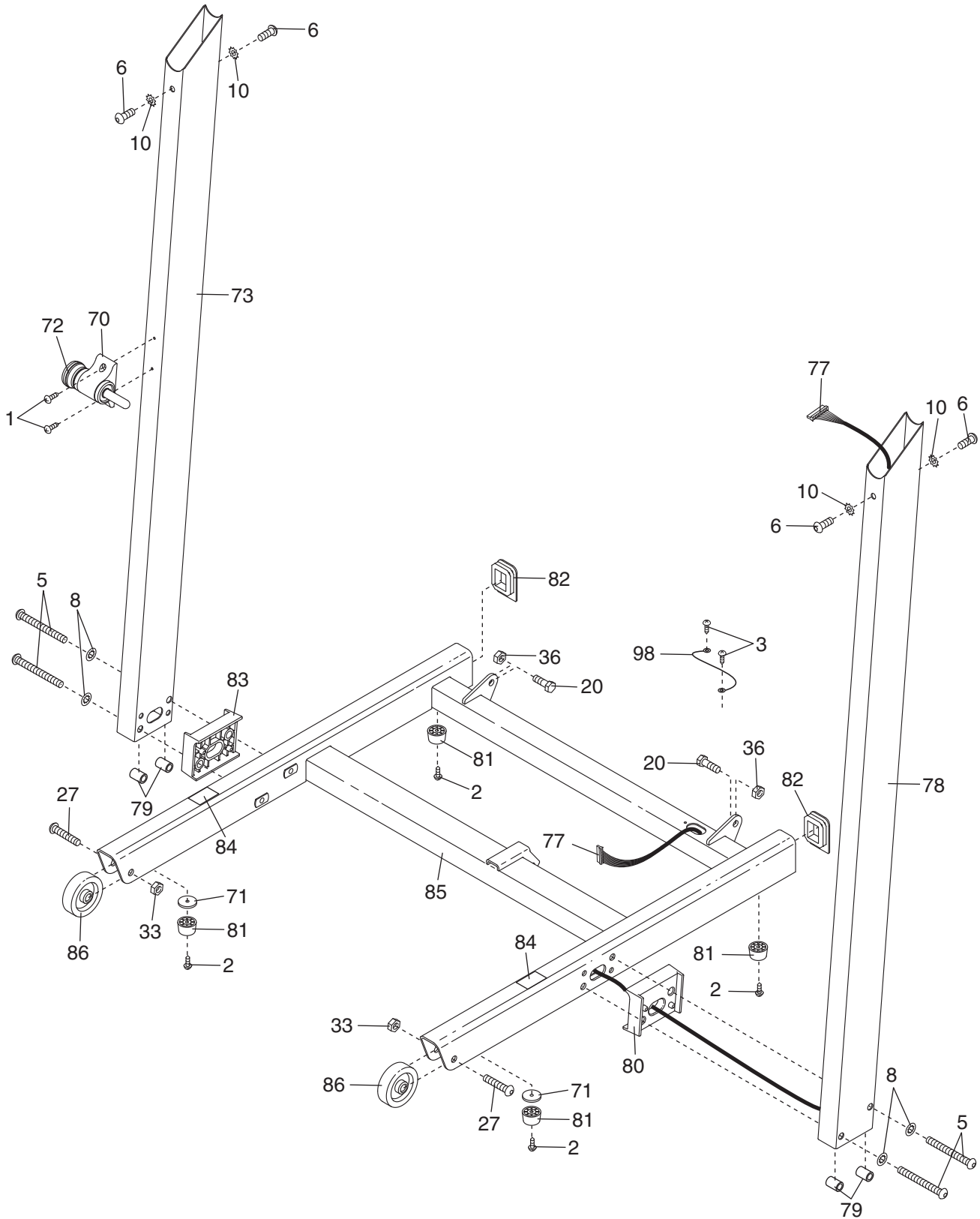

EXPLODED DRAWING D—Model No. PFTL39507.0

R0607A

