

# EXPLODED DRAWING A—Model No. PFTL39507.2

R0608A

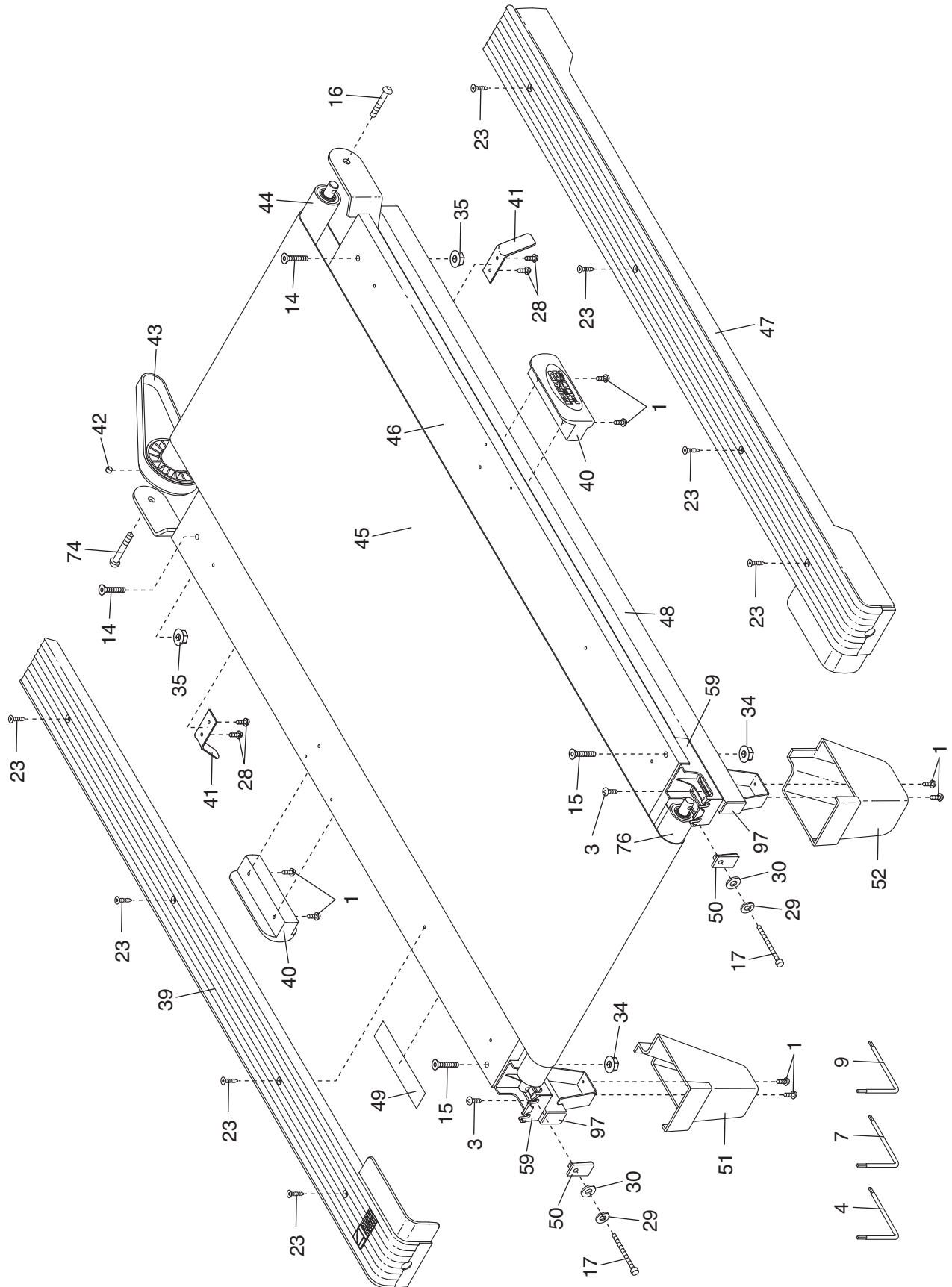

# EXPLODED DRAWING B—Model No. PFTL39507.2

R0608A

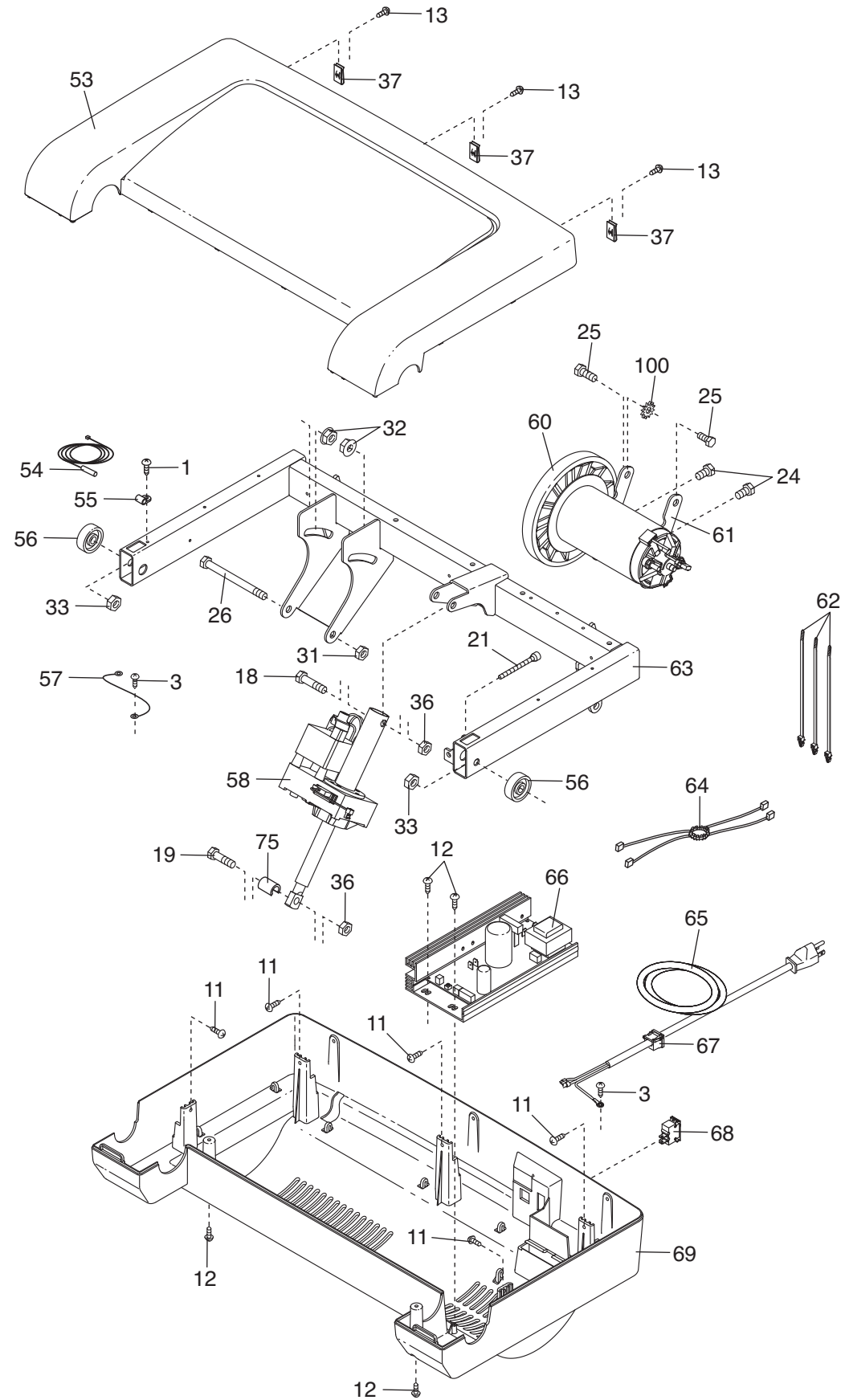

# EXPLODED DRAWING C—Model No. PFTL39507.2

R0608A

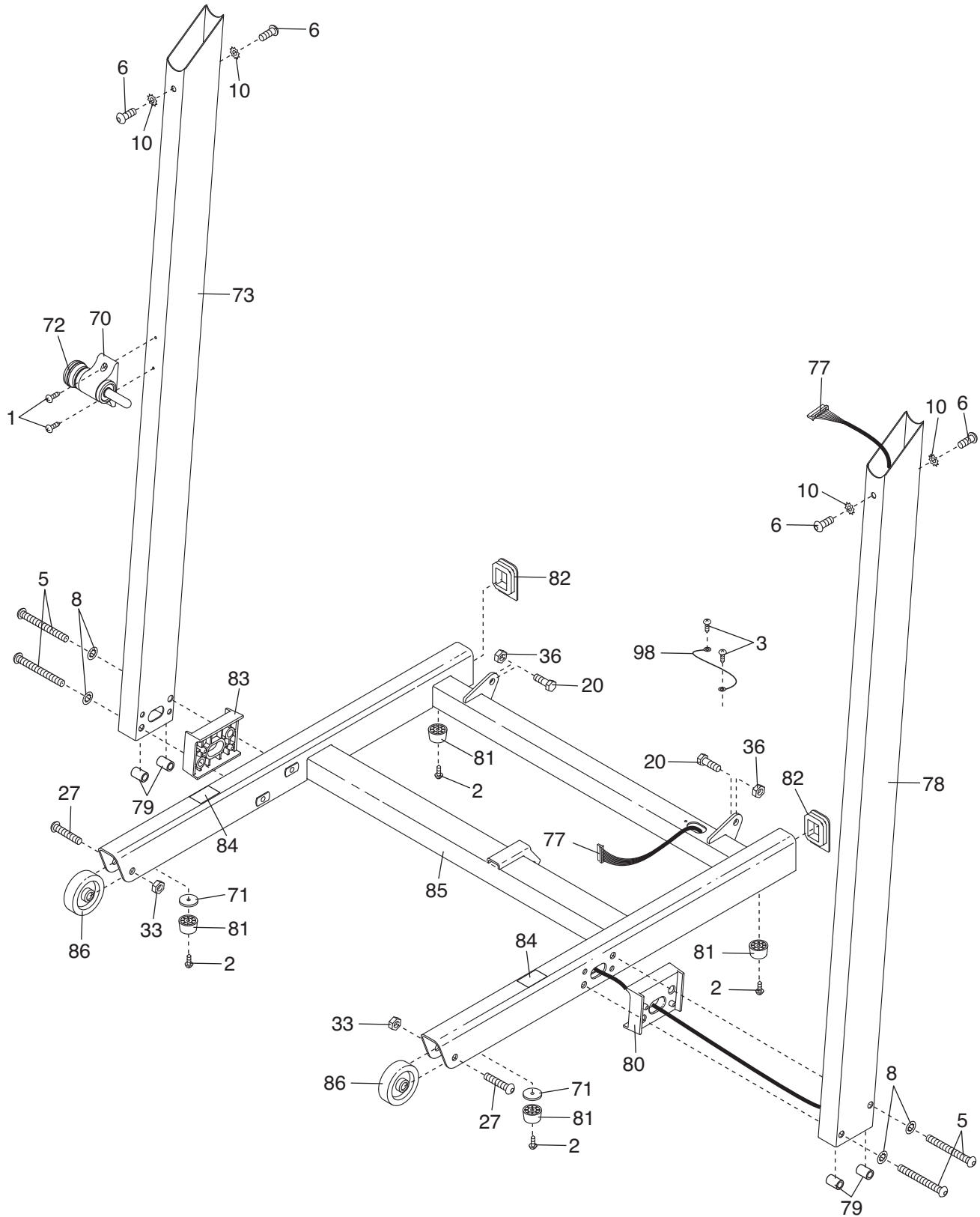

# EXPLODED DRAWING D—Model No. PFTL39507.2

R0608A

