

# EXPLODED DRAWING A—Model No. PFTL39507.4

R0708A

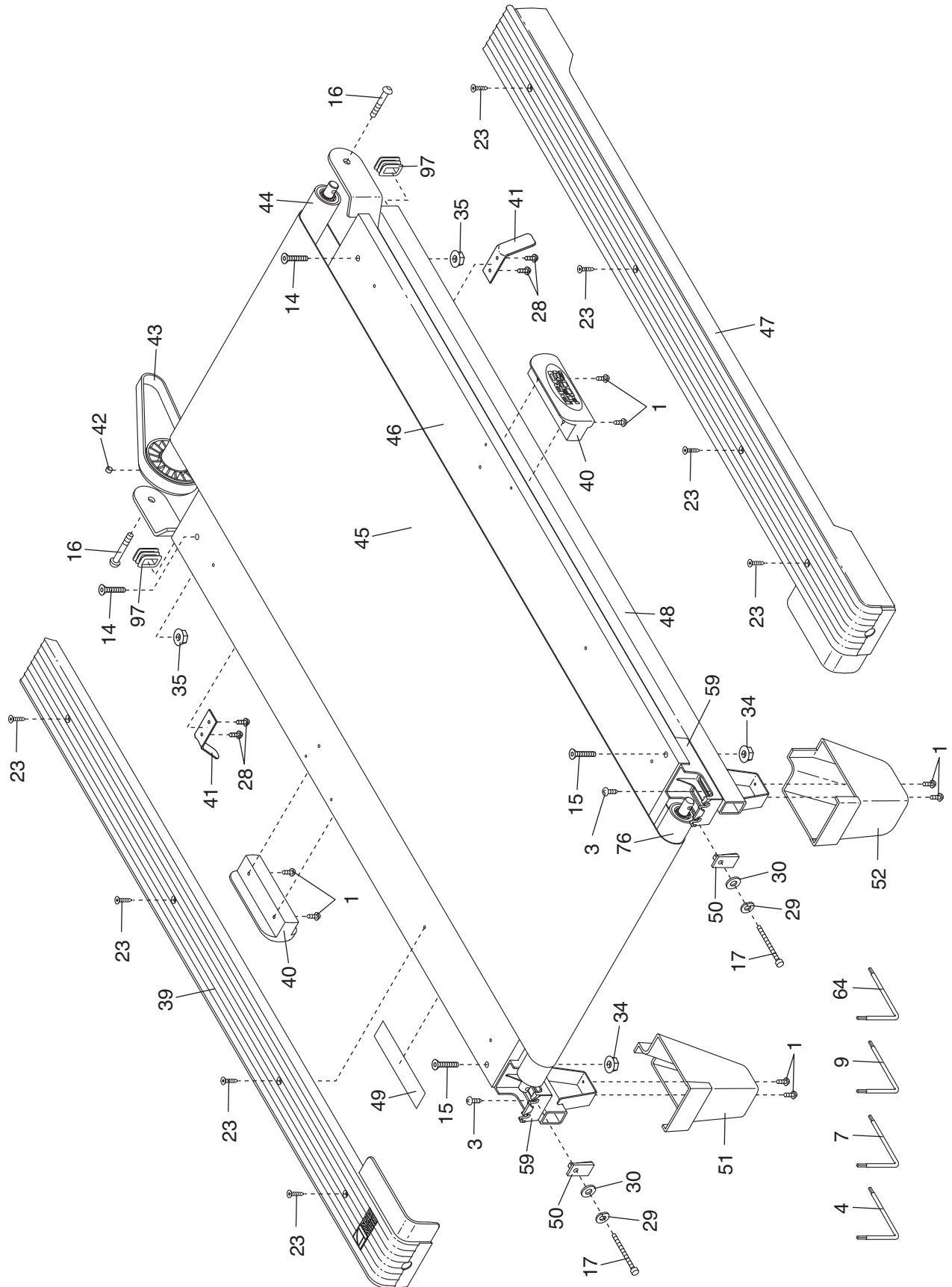

# EXPLODED DRAWING B—Model No. PFTL39507.4

R0708A

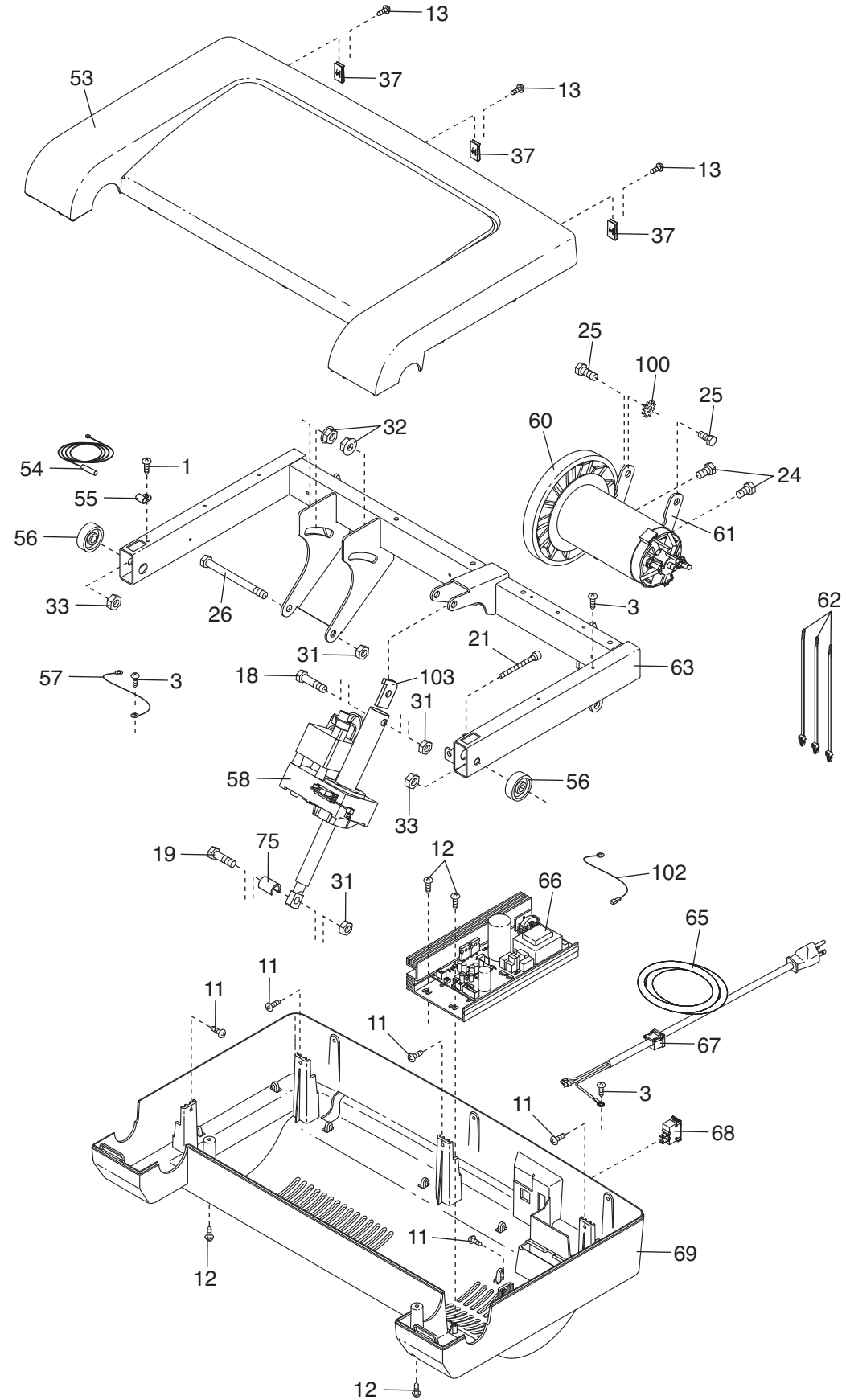

# EXPLODED DRAWING C—Model No. PFTL39507.4

R0708A

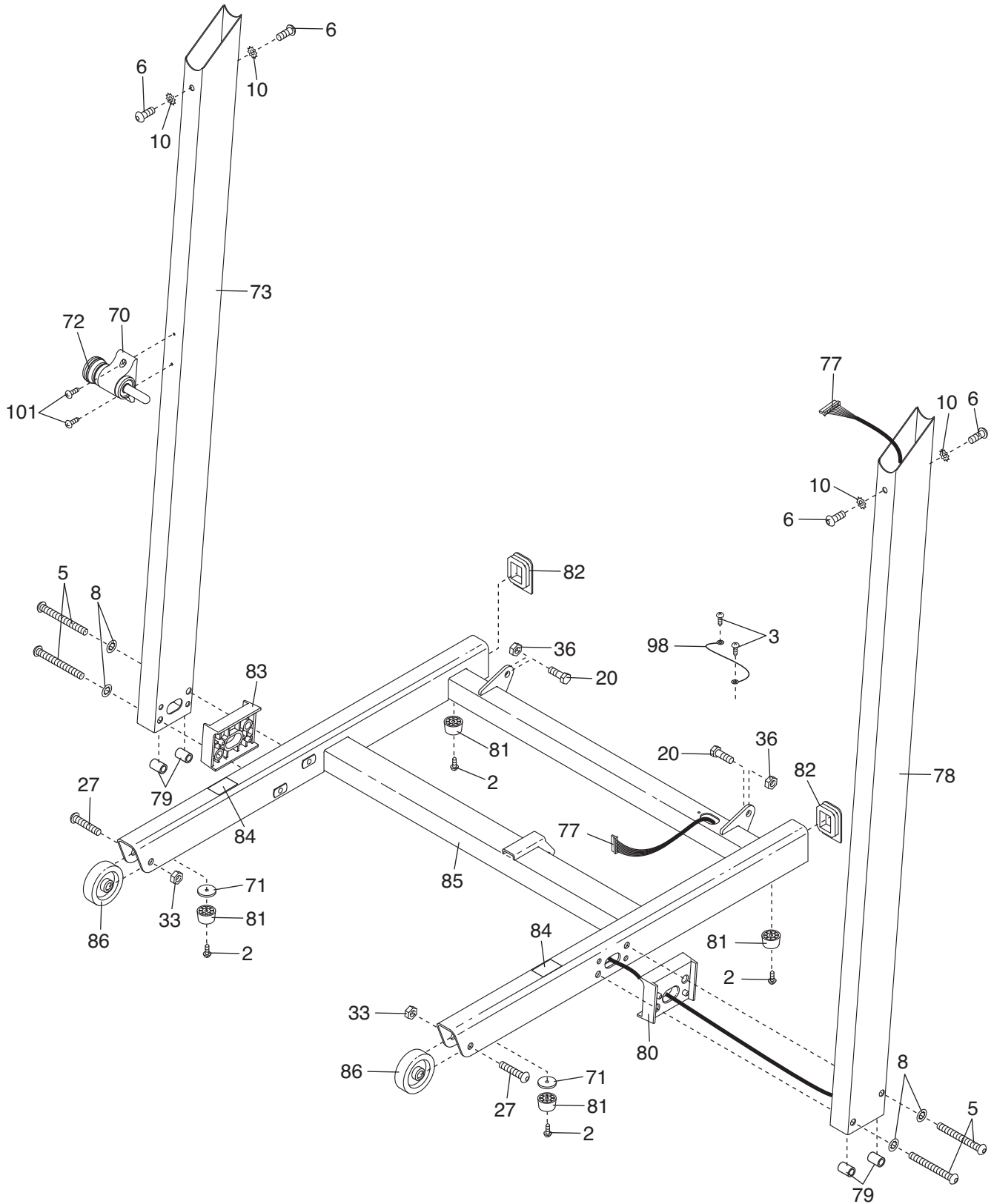

# EXPLODED DRAWING D—Model No. PFTL39507.4

R0708A

