

EXPLODED DRAWING B

Model No. PFTL39511.3 R0413A

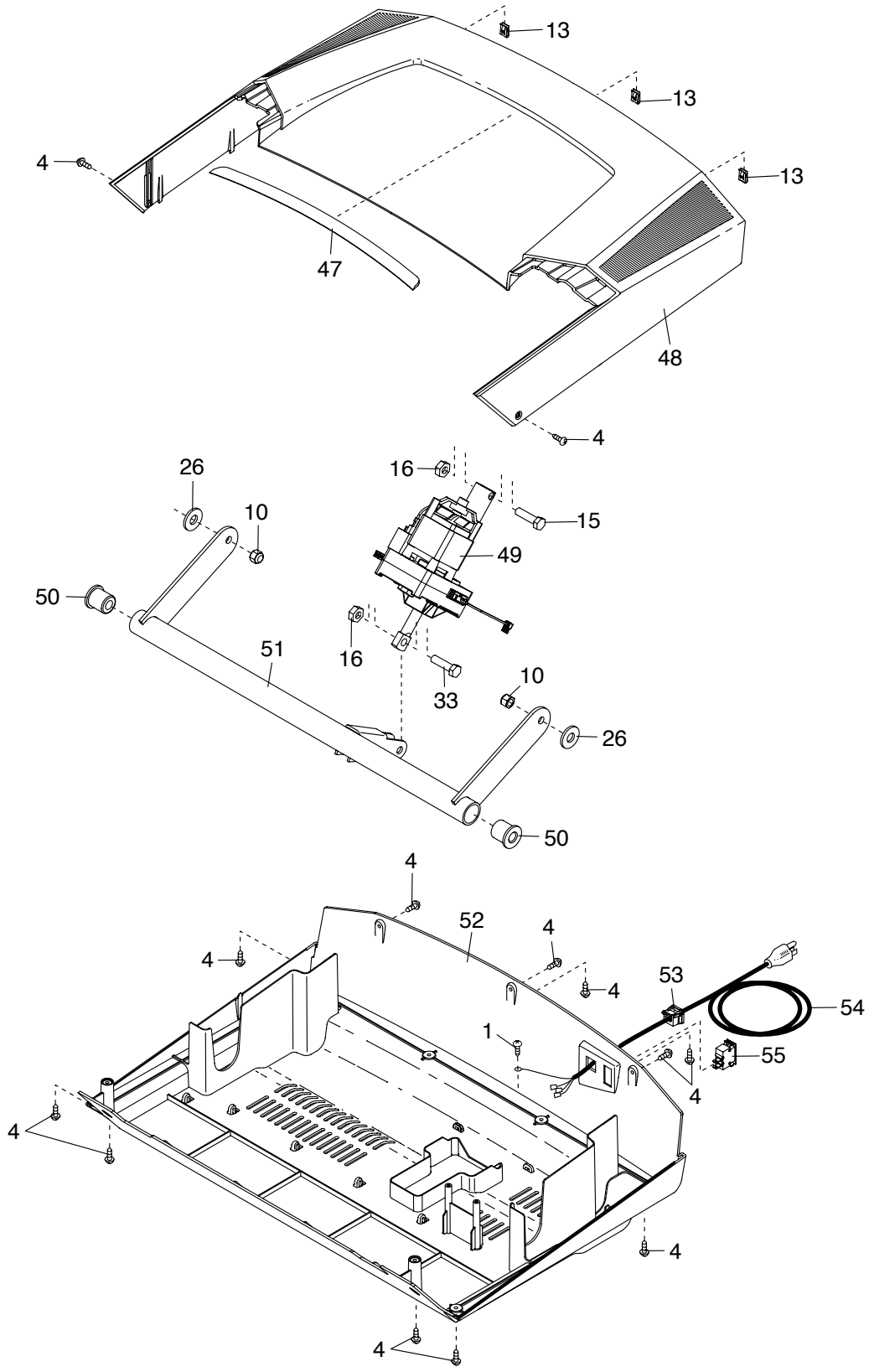

EXPLODED DRAWING C

Model No. PFTL39511.3 R0413A

