

EXPLODED DRAWING A

Model No. PFTL39511.4 R0113A

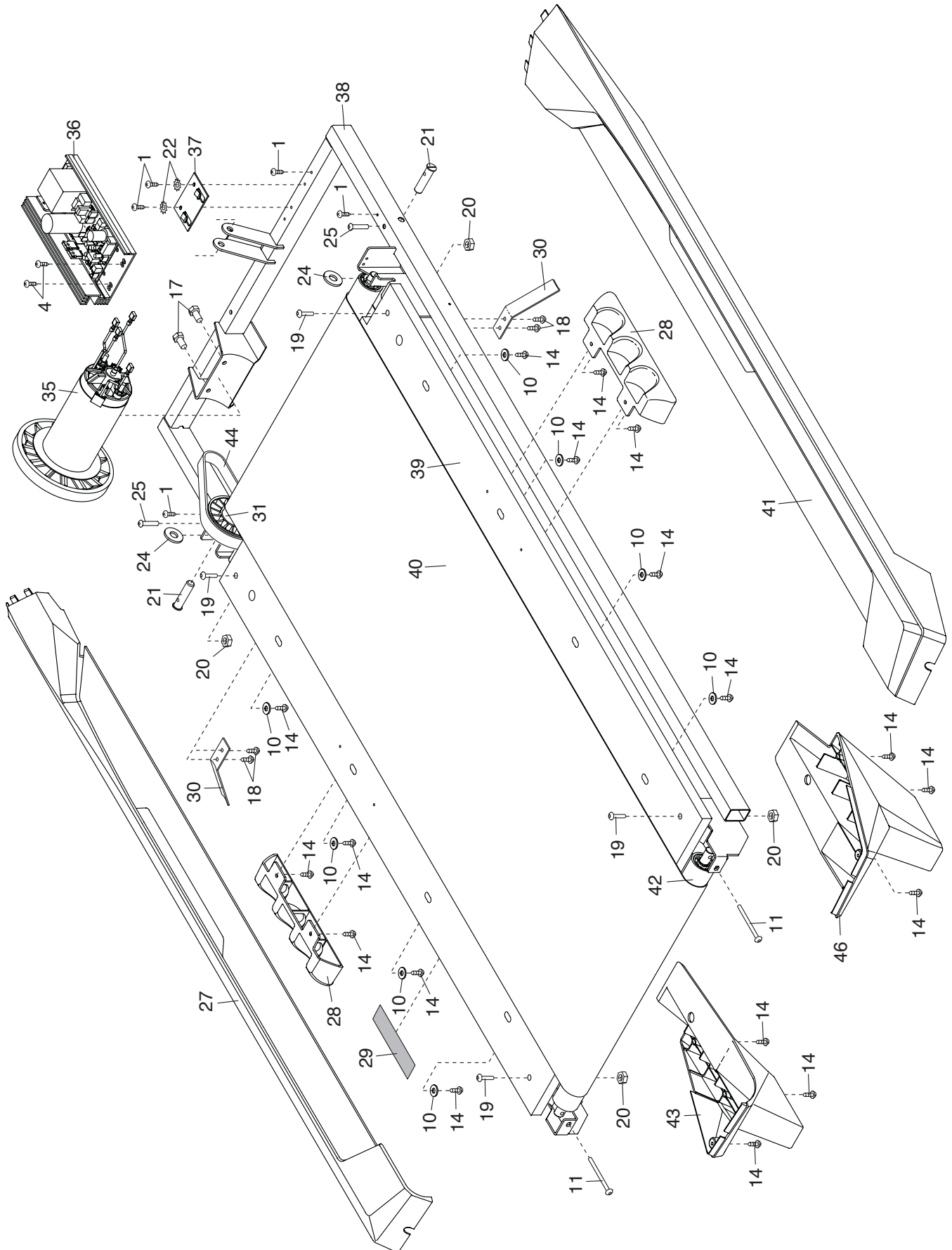

EXPLODED DRAWING B

Model No. PFTL39511.4 R0113A

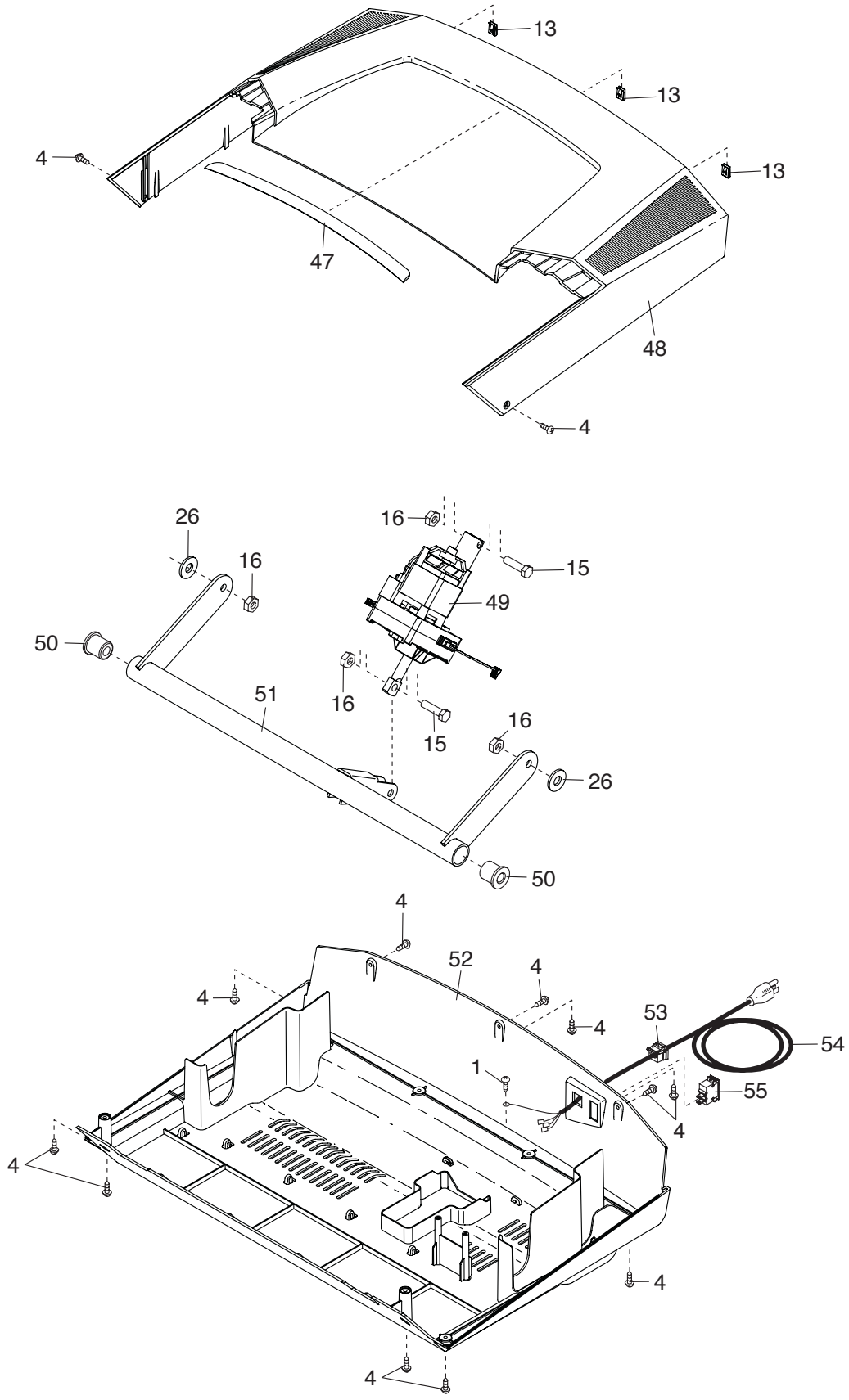

EXPLODED DRAWING C

Model No. PFTL39511.4 R0113A

