

EXPLODED DRAWING A

Model No. PFTL39511.5 R1113A

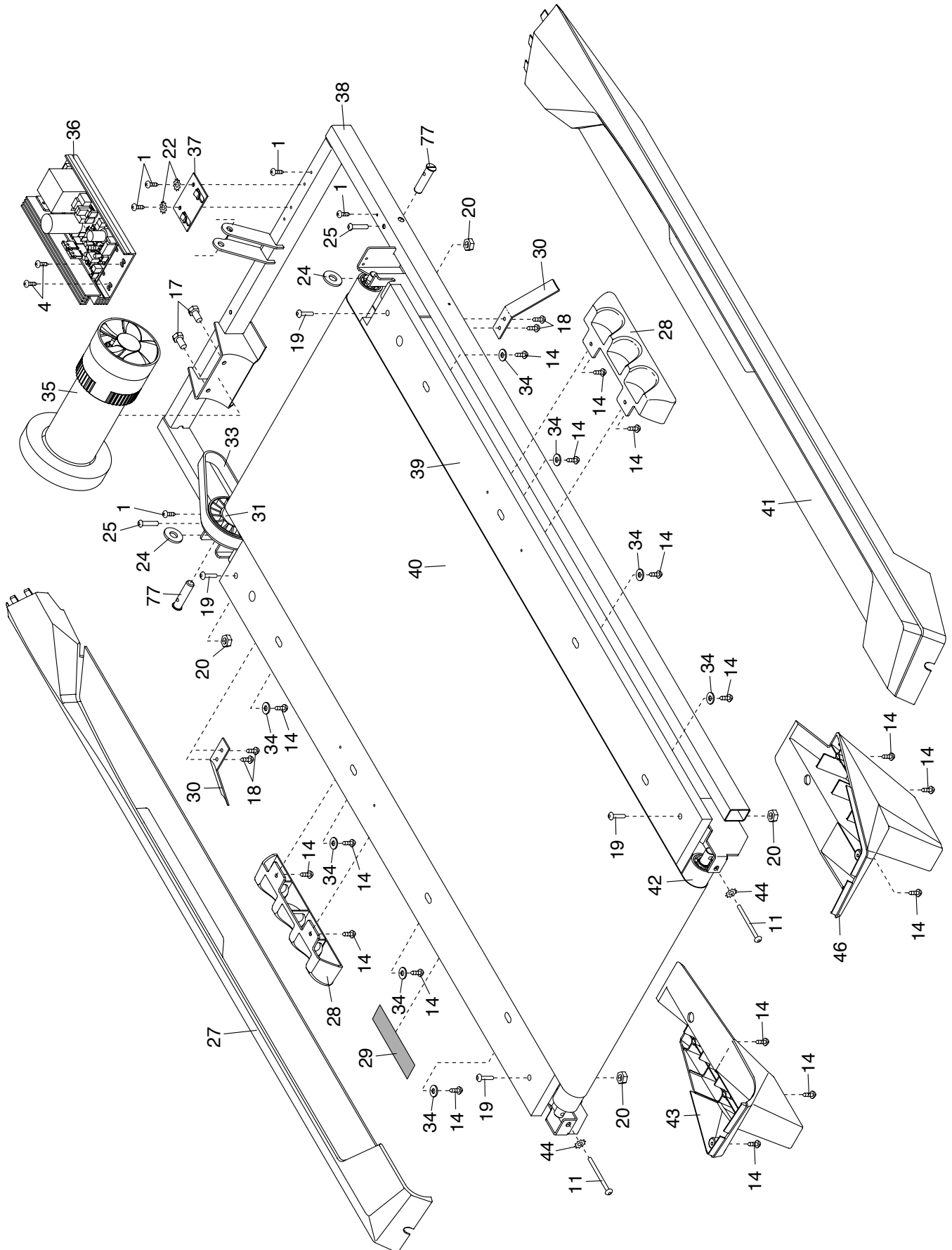

EXPLODED DRAWING B

Model No. PFTL39511.5 R1113A

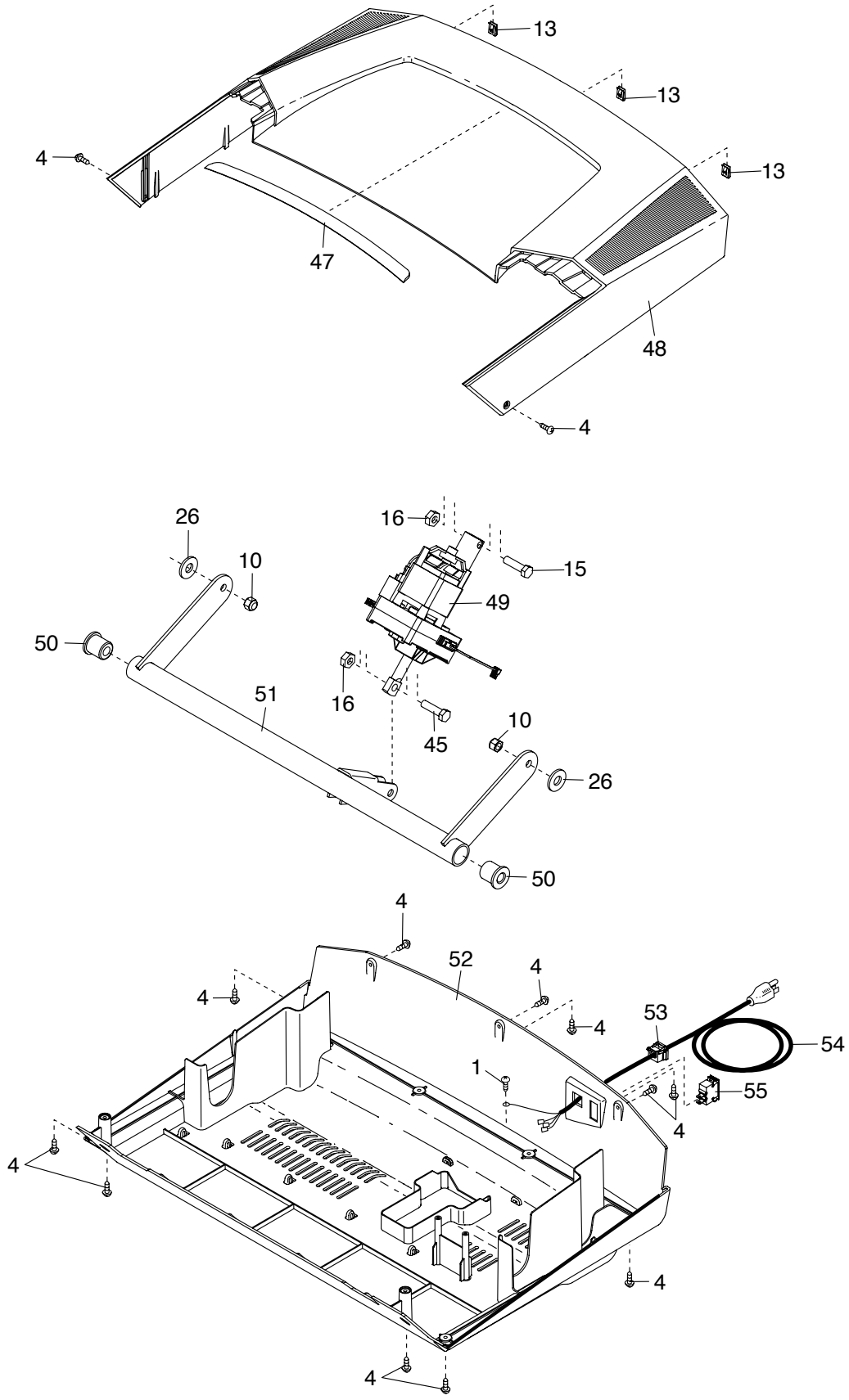

EXPLODED DRAWING C

Model No. PFTL39511.5 R1113A

