

# EXPLODED DRAWING A

Model No. PFTL39511.8 R1214A

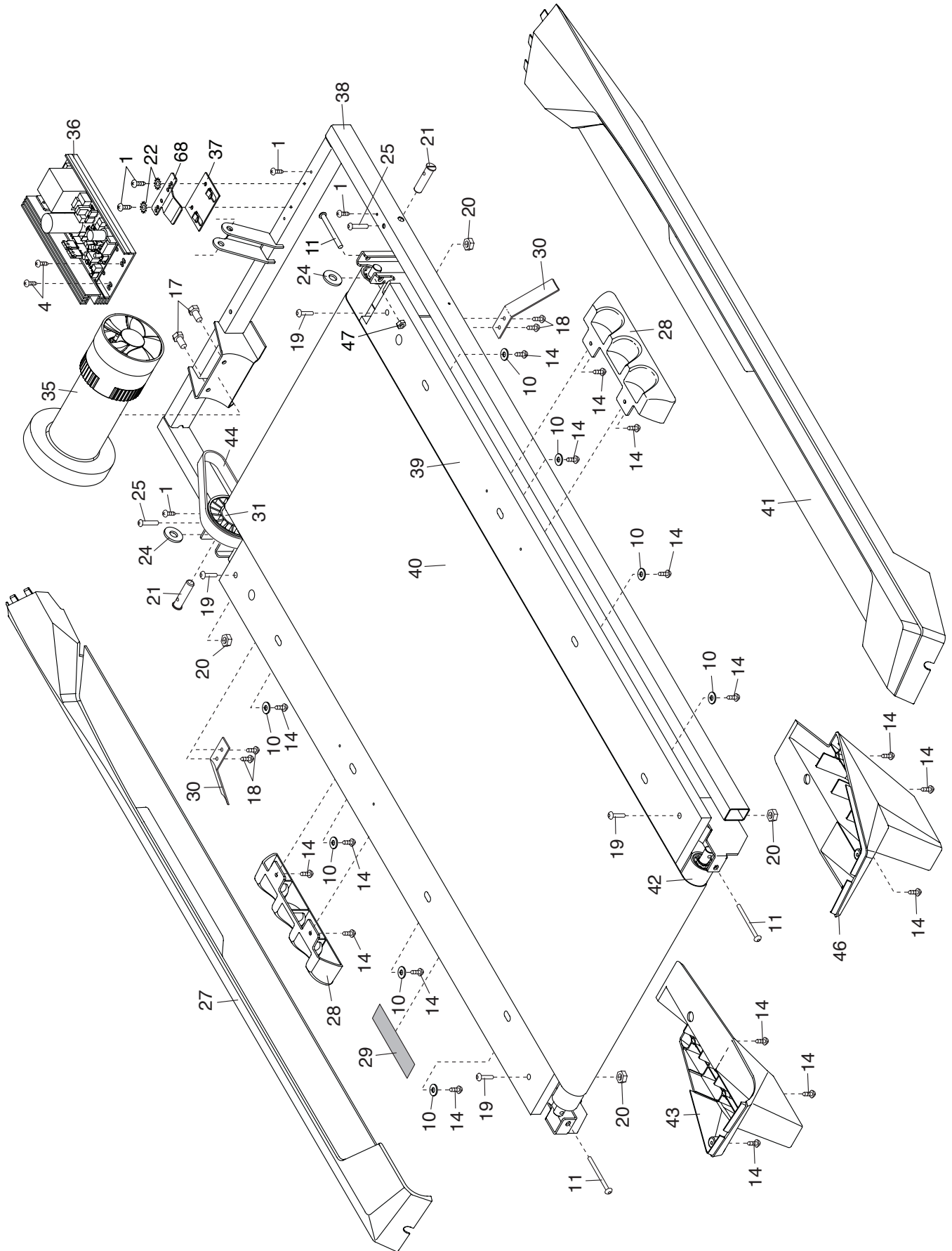

# EXPLODED DRAWING B

Model No. PFTL39511.8 R1214A

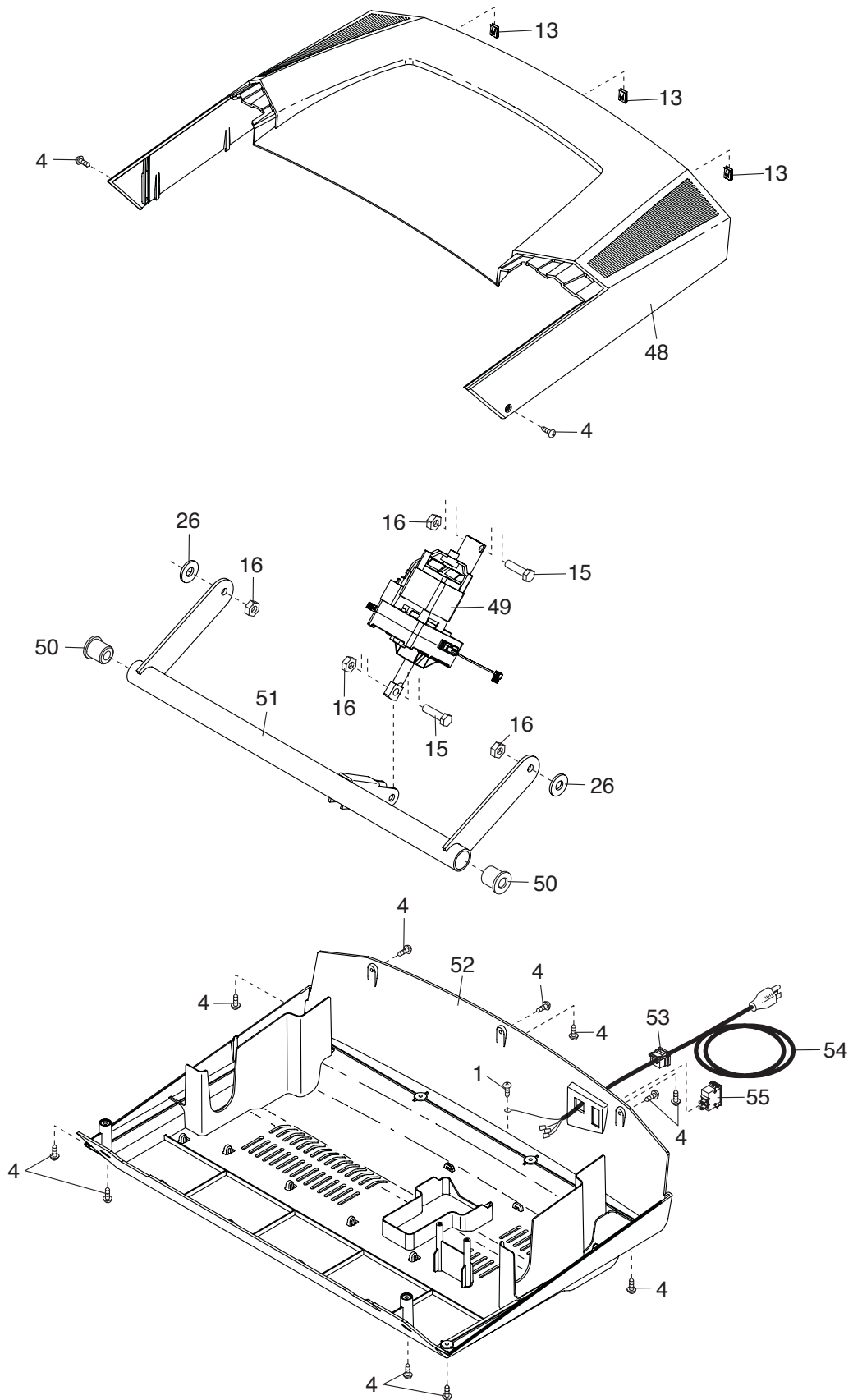

# EXPLODED DRAWING C

Model No. PFTL39511.8 R1214A

