

EXPLODED DRAWING A

Model No. PFTL39511.2 R1212A

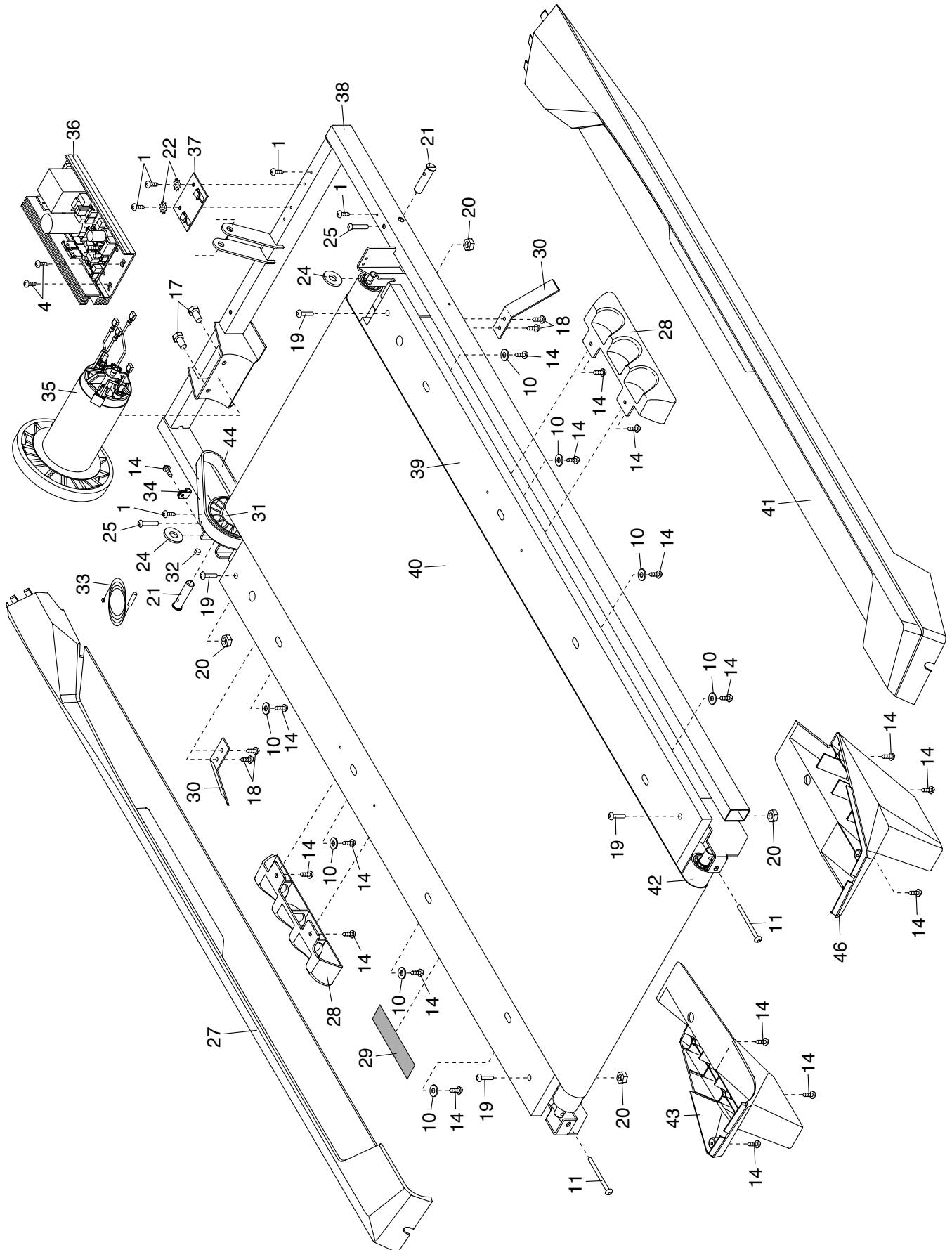

EXPLODED DRAWING B

Model No. PFTL39511.2 R1212A

