

EXPLODED DRAWING A

Model No. PFTL39513.1 R0315A

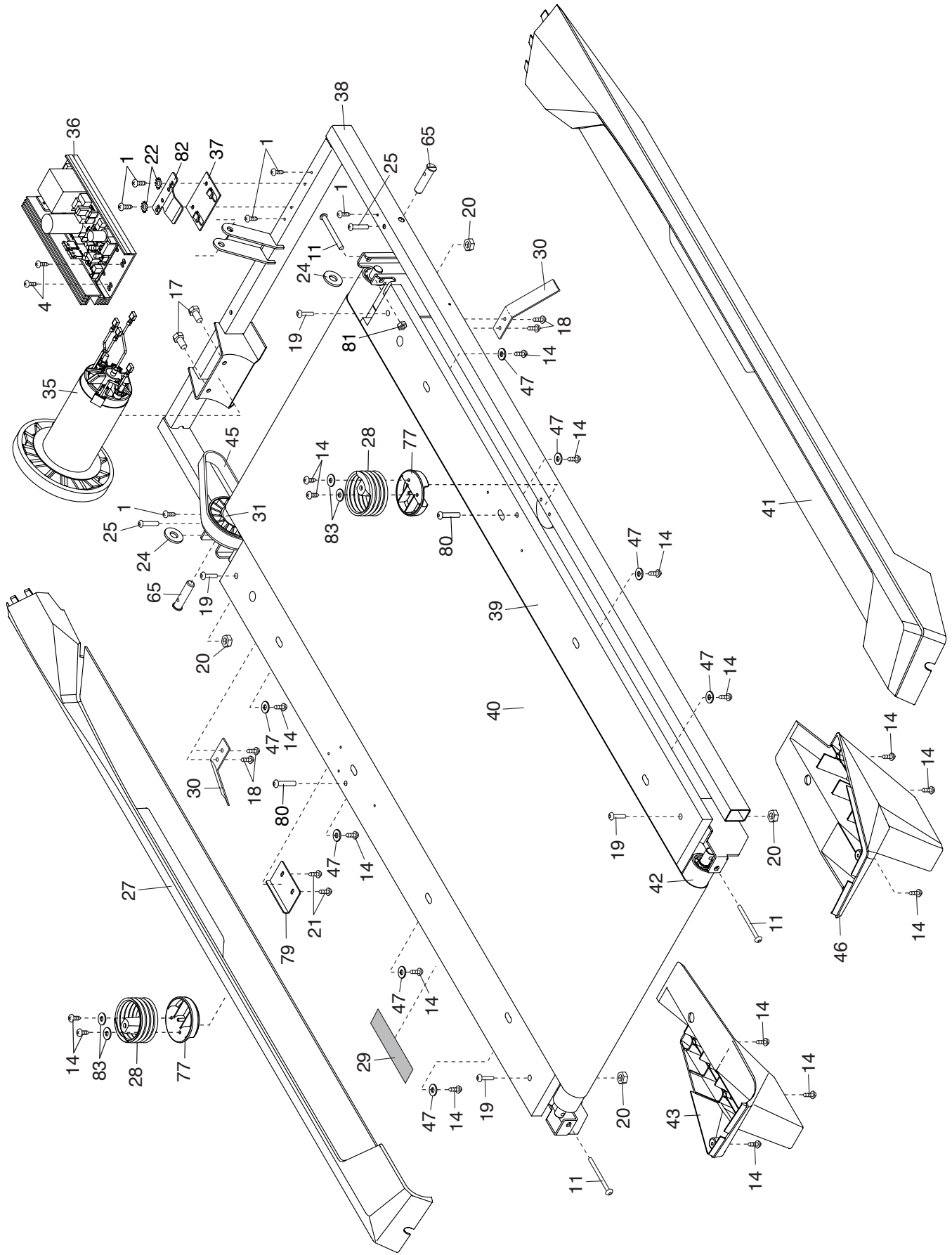

EXPLODED DRAWING B

Model No. PFTL39513.1 R0315A

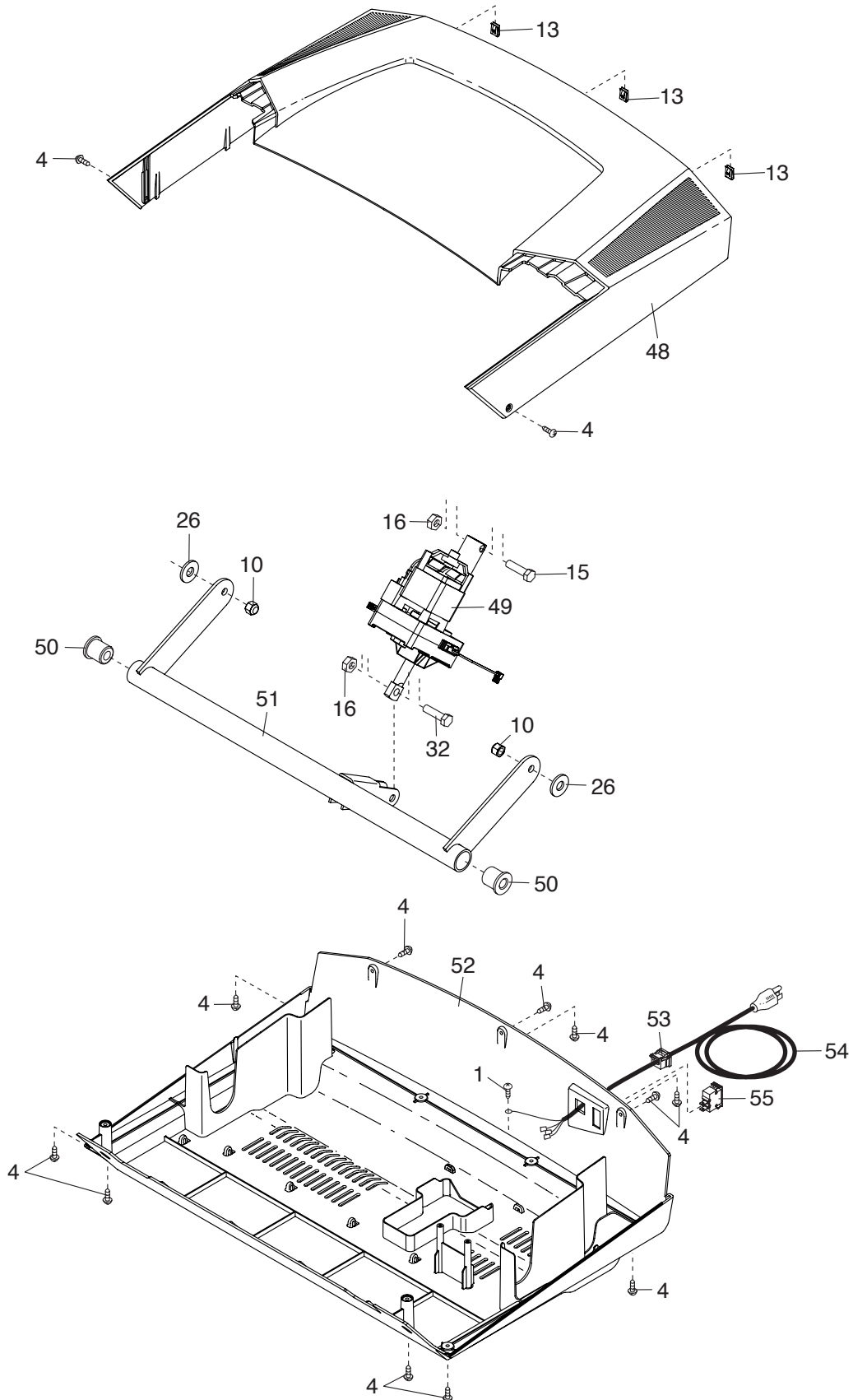

EXPLODED DRAWING C

Model No. PFTL39513.1 R0315A

