

EXPLODED DRAWING A

Model No. PFTL39715.0 R0715A

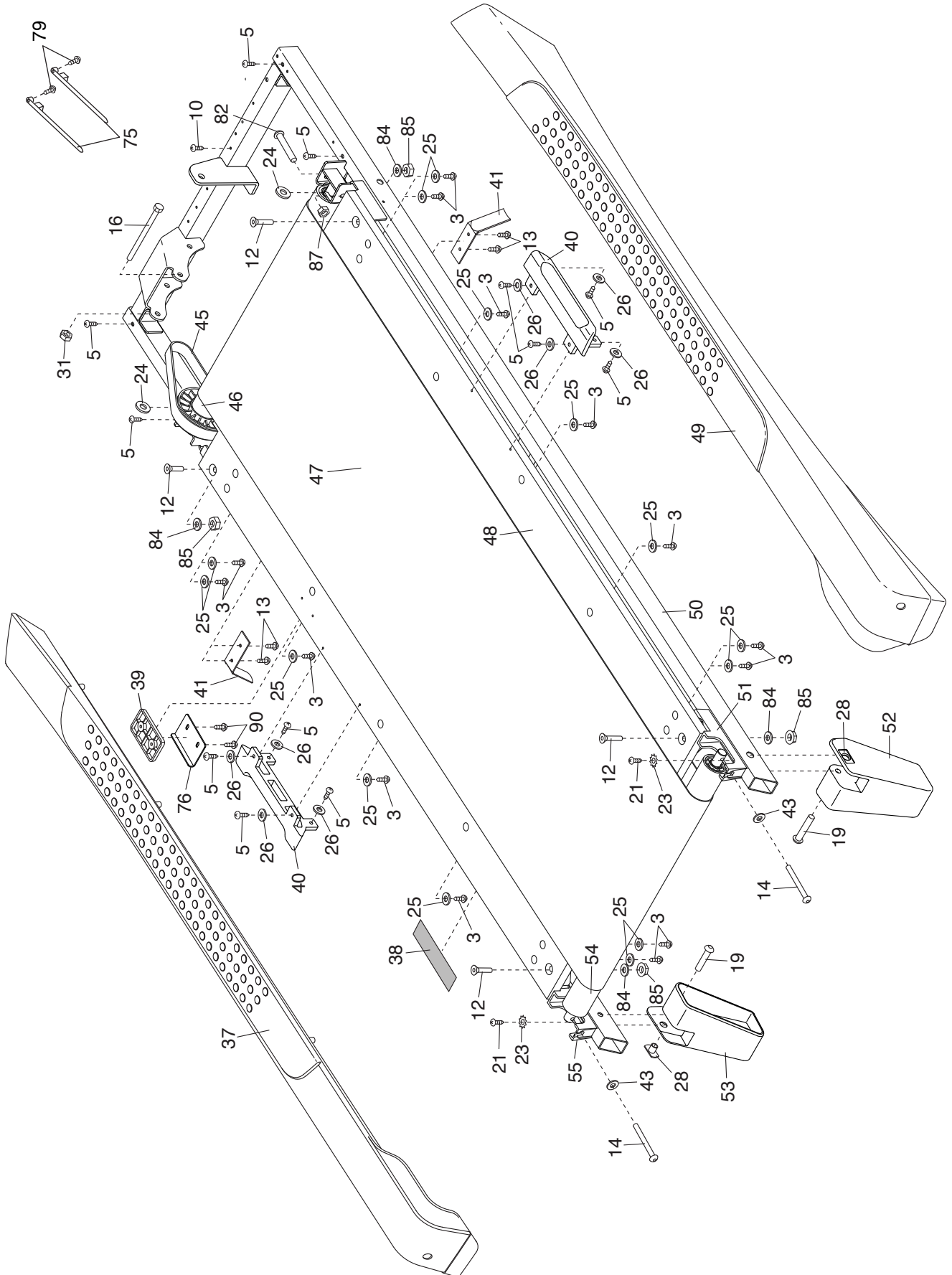

EXPLODED DRAWING B

Model No. PFTL39715.0 R0715A

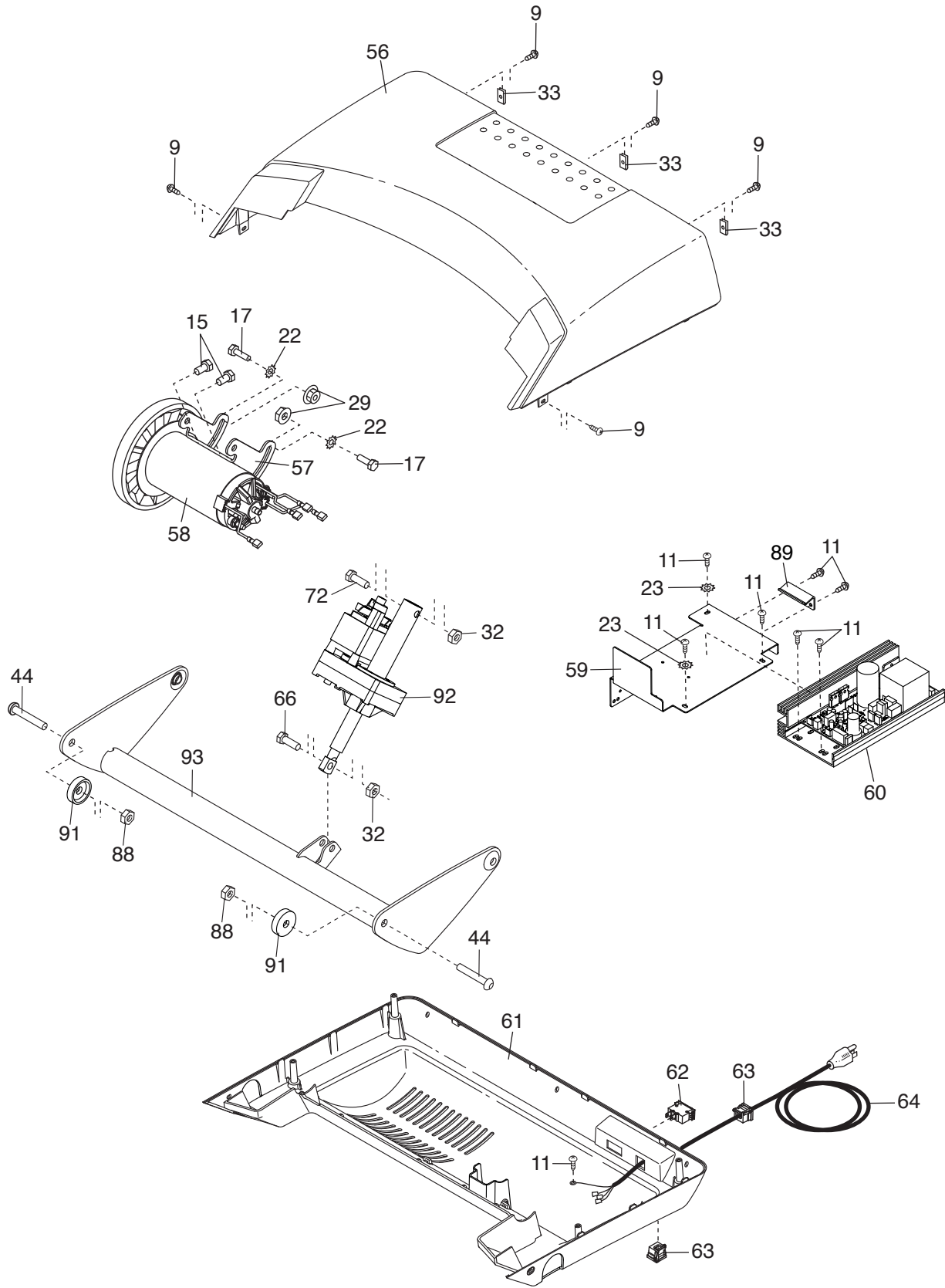

EXPLODED DRAWING C

Model No. PFTL39715.0 R0715A

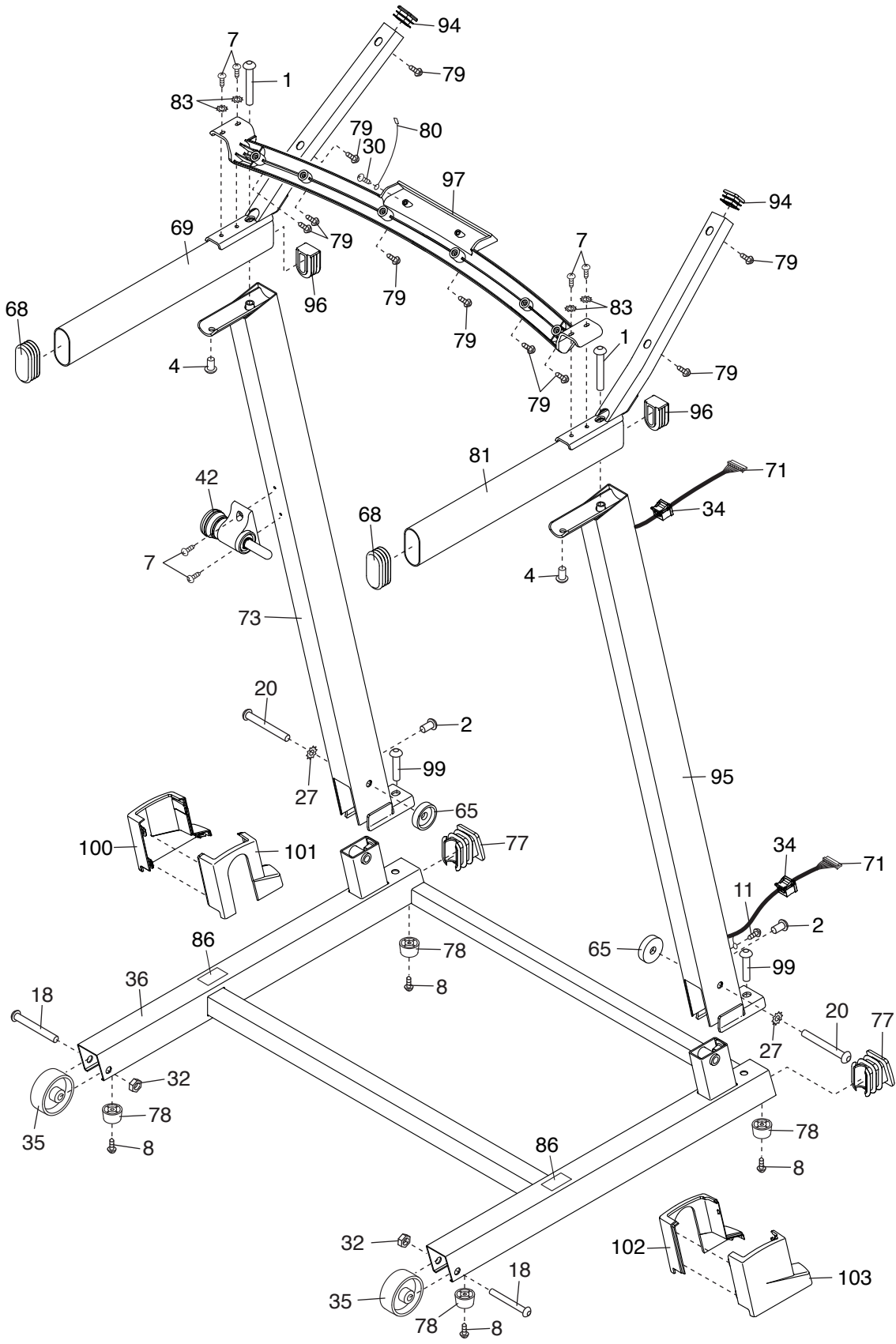

EXPLODED DRAWING D

Model No. PFTL39715.0 R0715A

