

EXPLODED DRAWING A—Model No. PFTL39907.0

R0307A

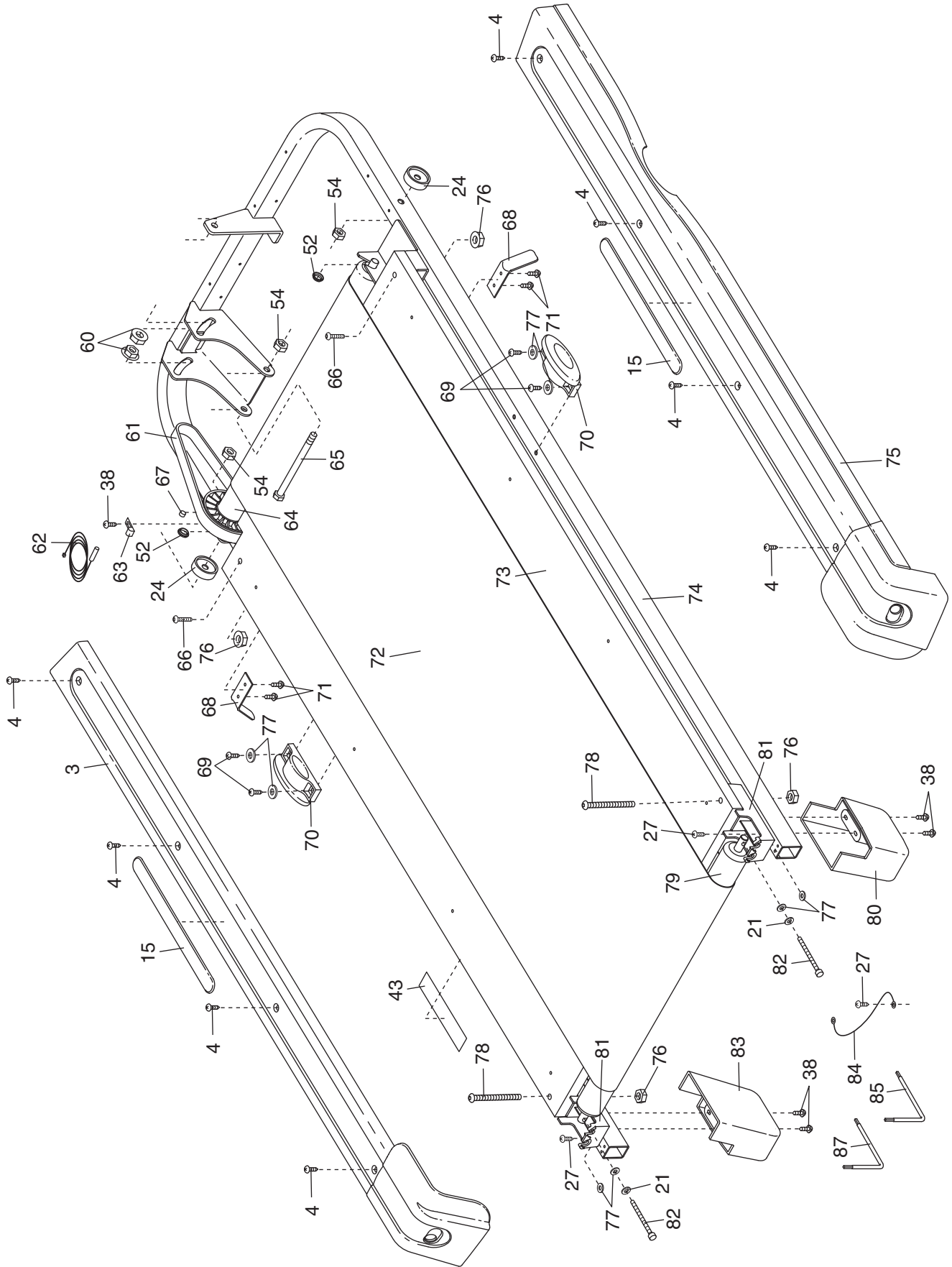

EXPLODED DRAWING B—Model No. PFTL39907.0

R0307A

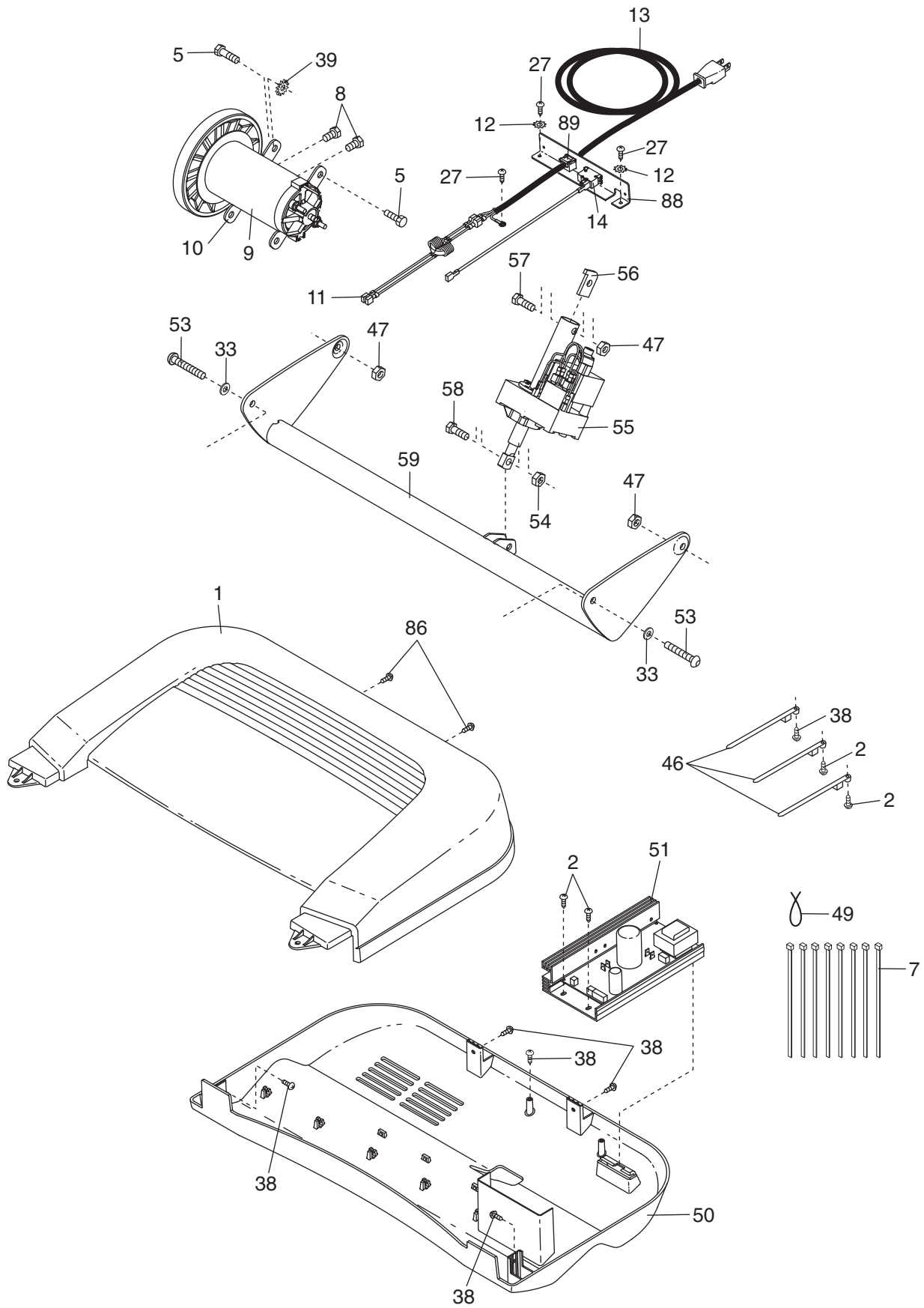

EXPLODED DRAWING C—Model No. PFTL39907.0

R0307A

