

EXPLODED DRAWING A

Model No. PFTL40012.4 R1214A

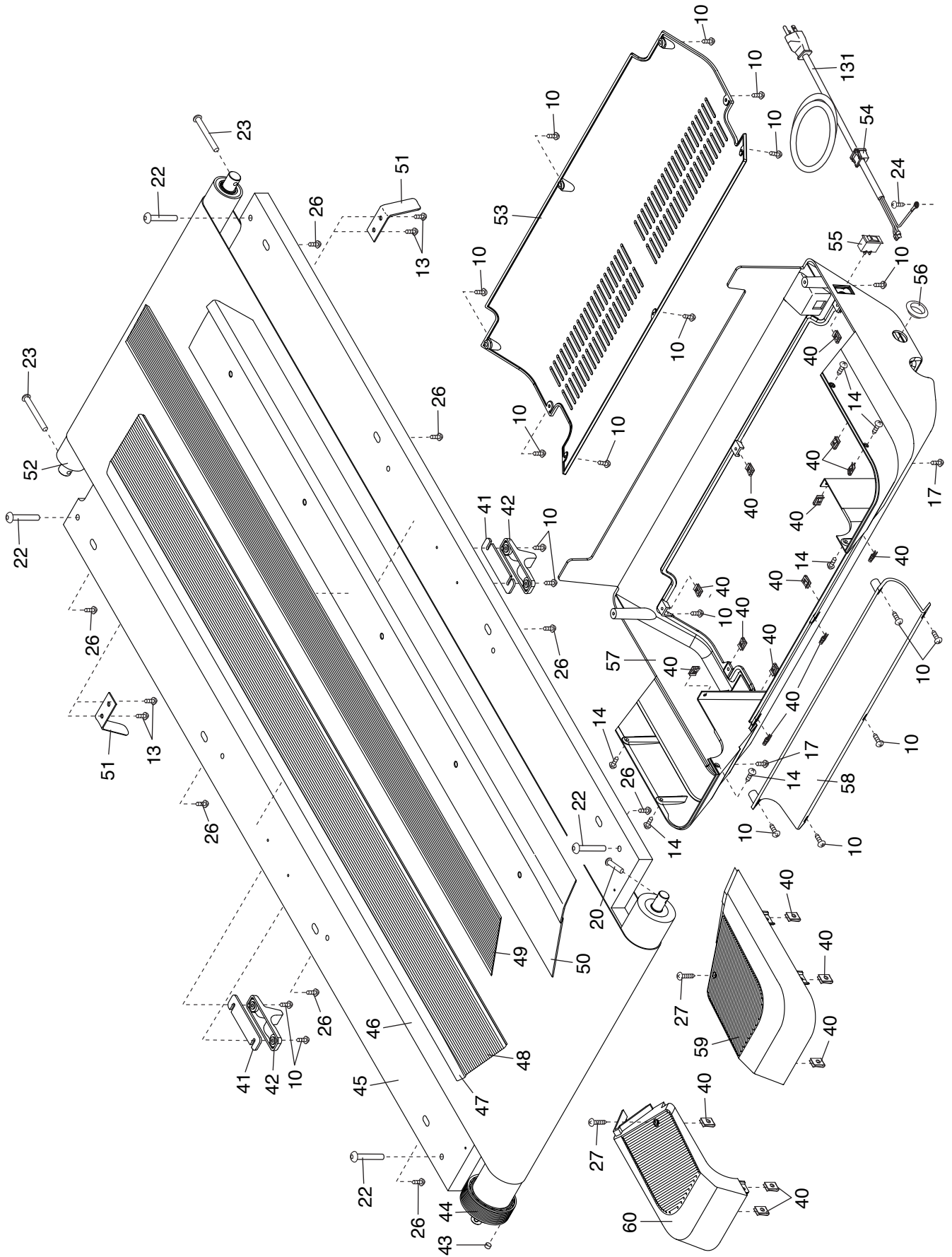

EXPLODED DRAWING B

Model No. PFTL40012.4 R1214A

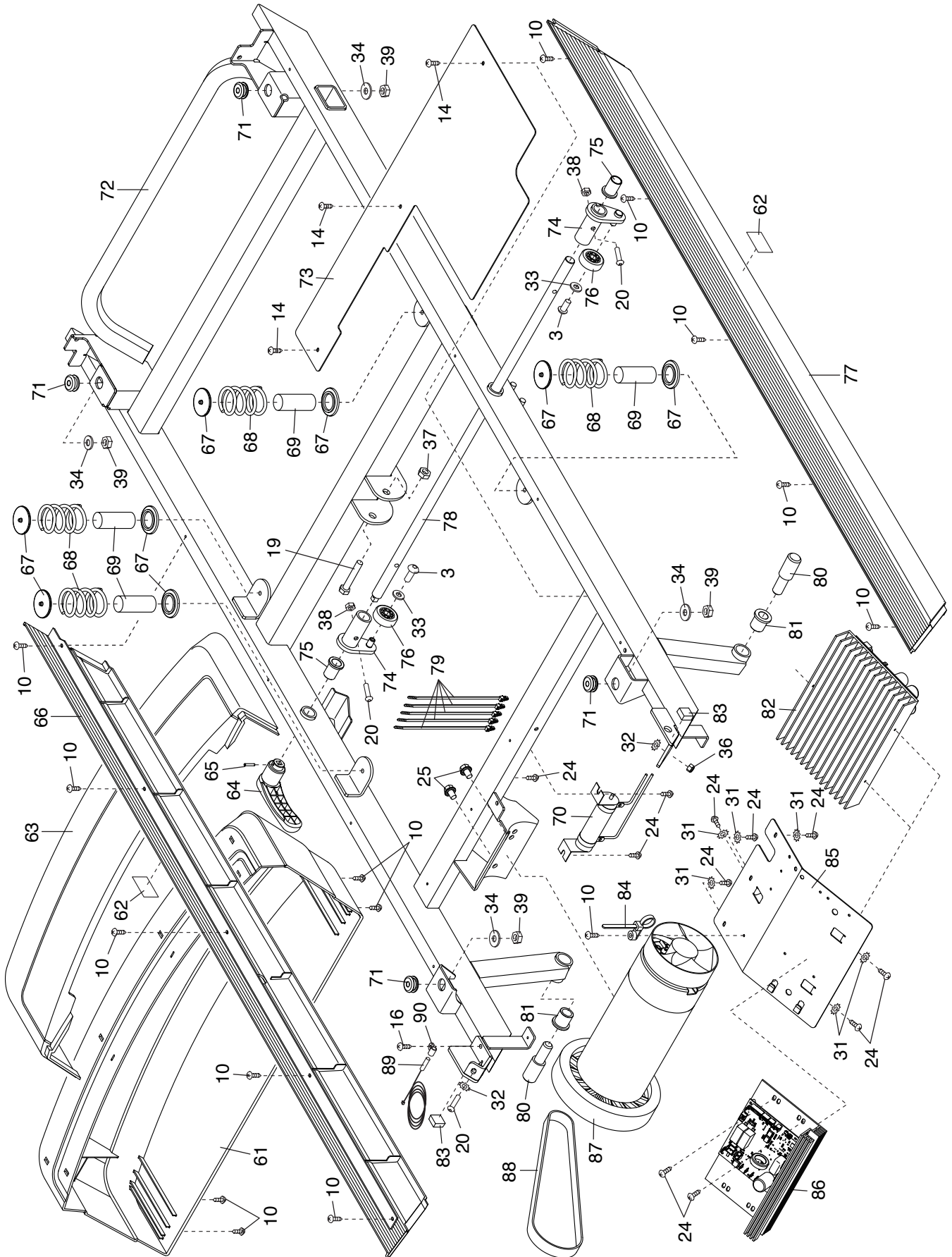

EXPLODED DRAWING C

Model No. PFTL40012.4 R1214A

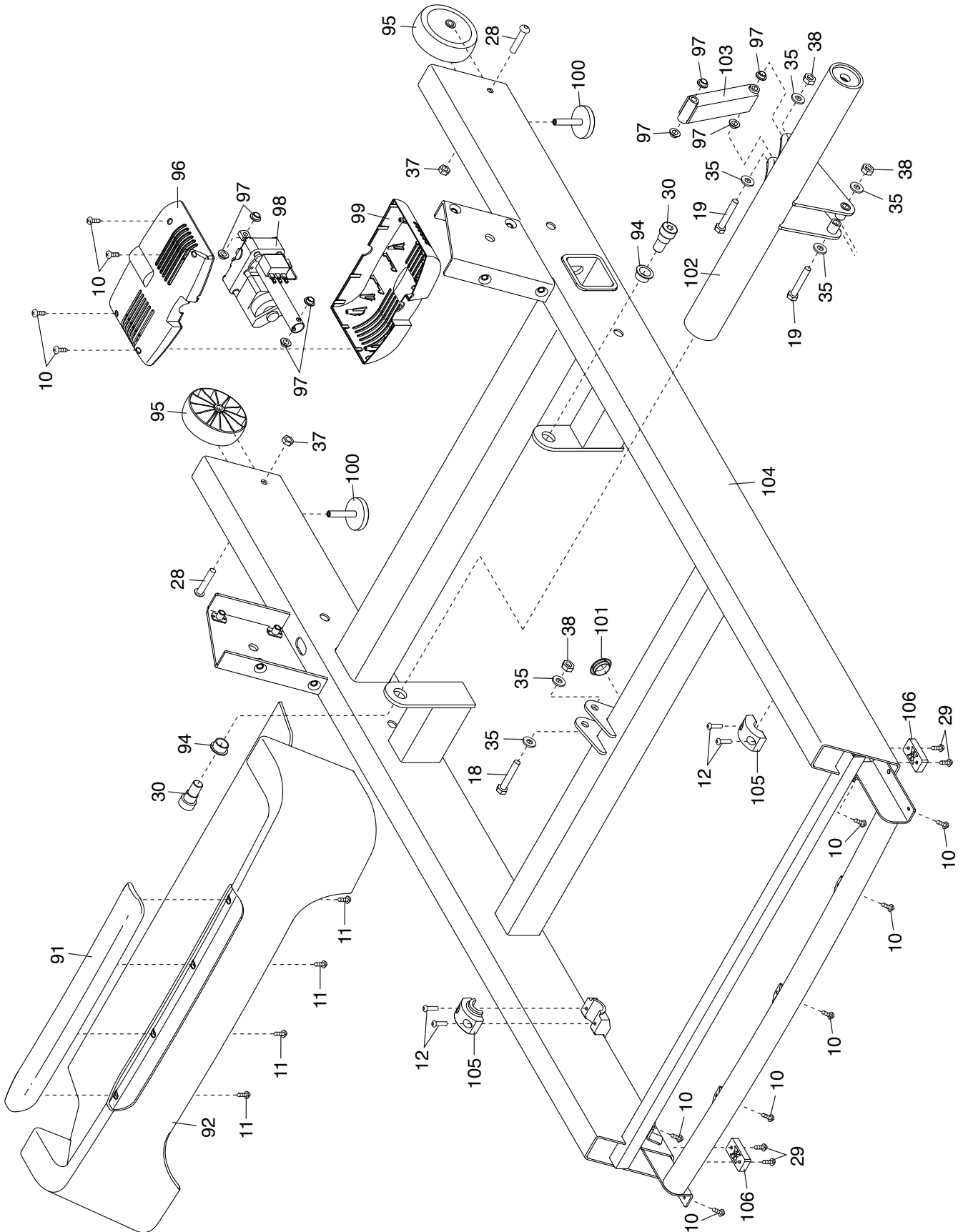

EXPLODED DRAWING D

Model No. PFTL40012.4 R1214A

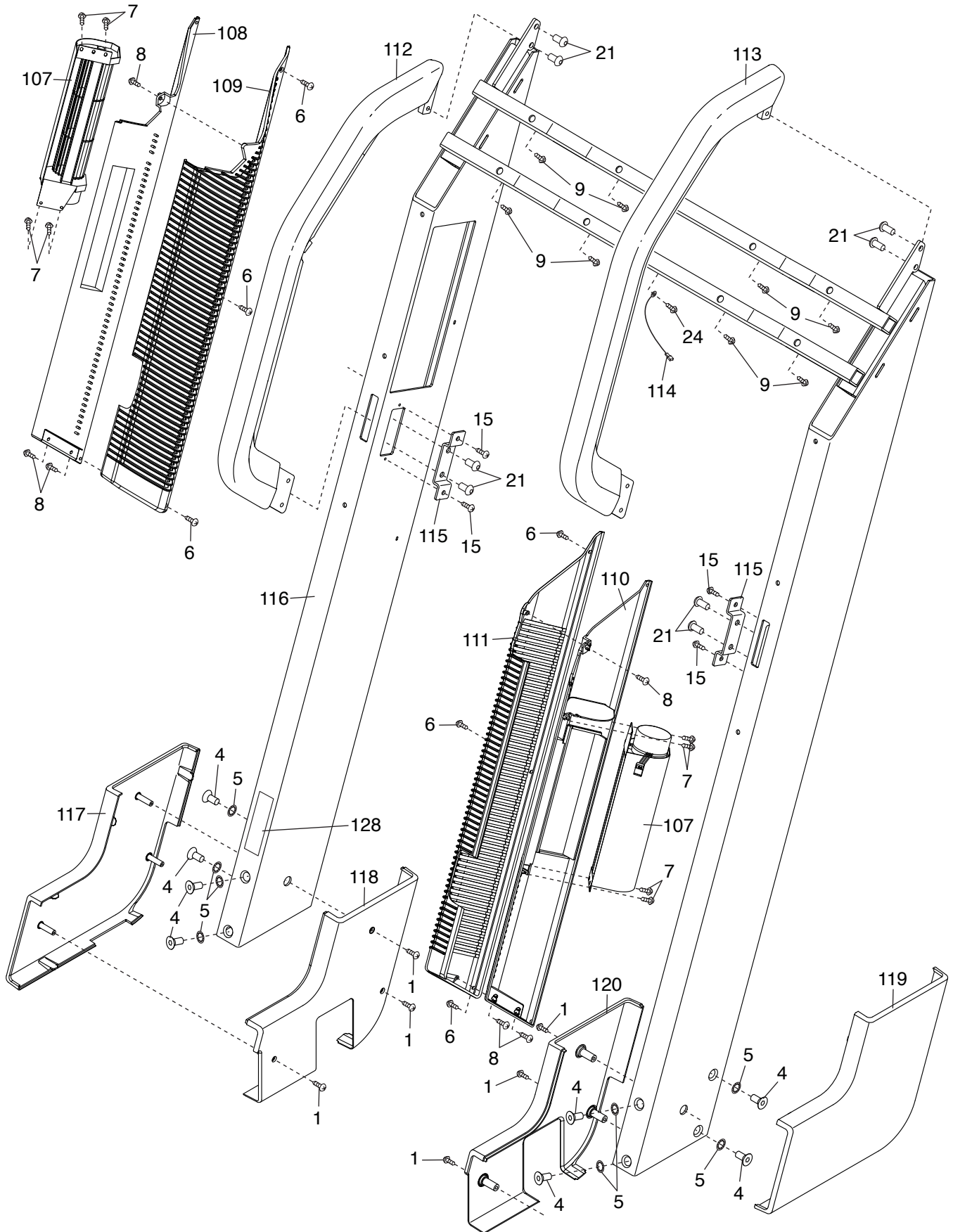

EXPLODED DRAWING E

Model No. PFTL40012.4 R1214A

