

# EXPLODED DRAWING A

Model No. PFTL40916.0 R0816A

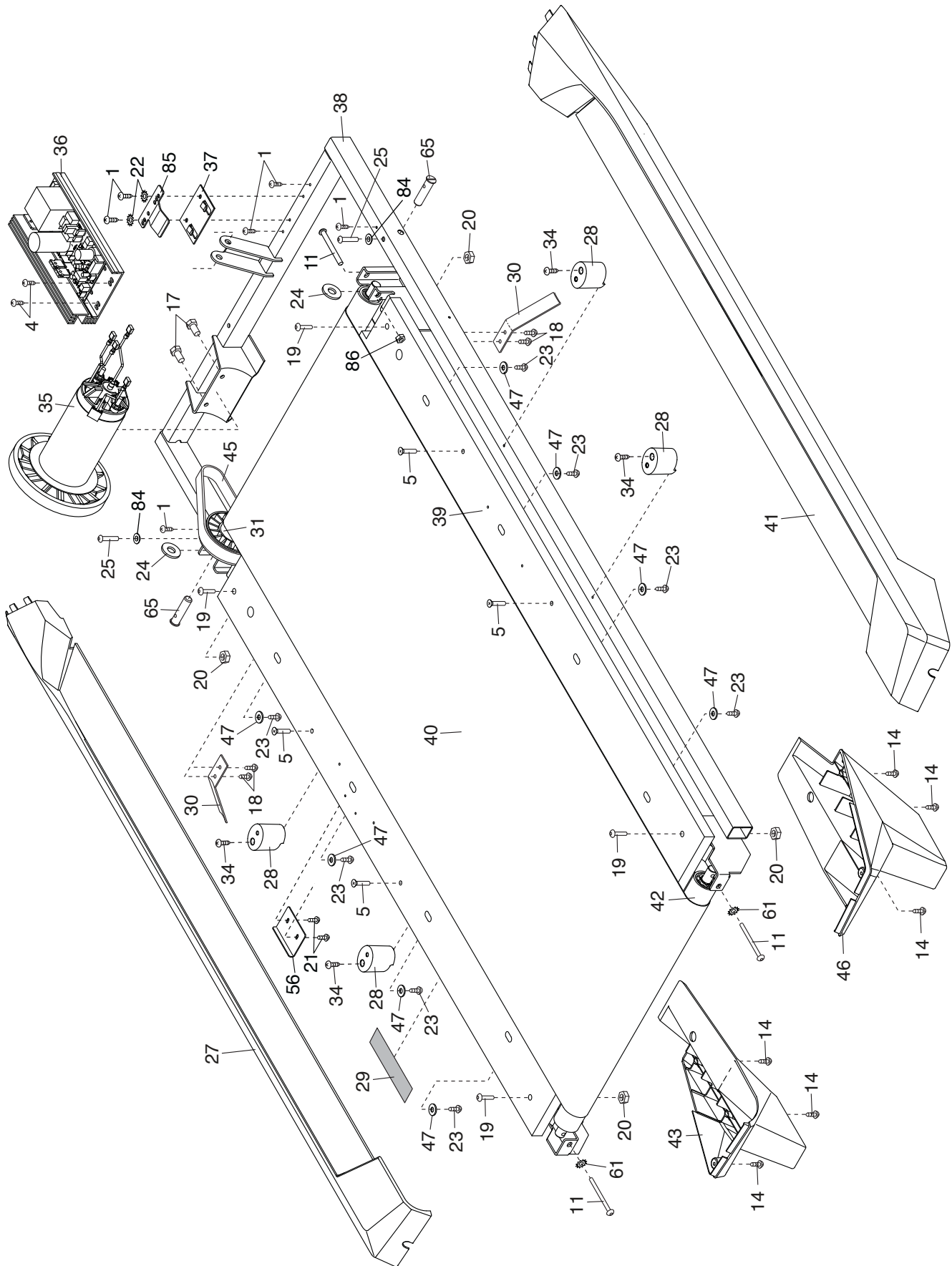

# EXPLODED DRAWING B

Model No. PFTL40916.0 R0816A

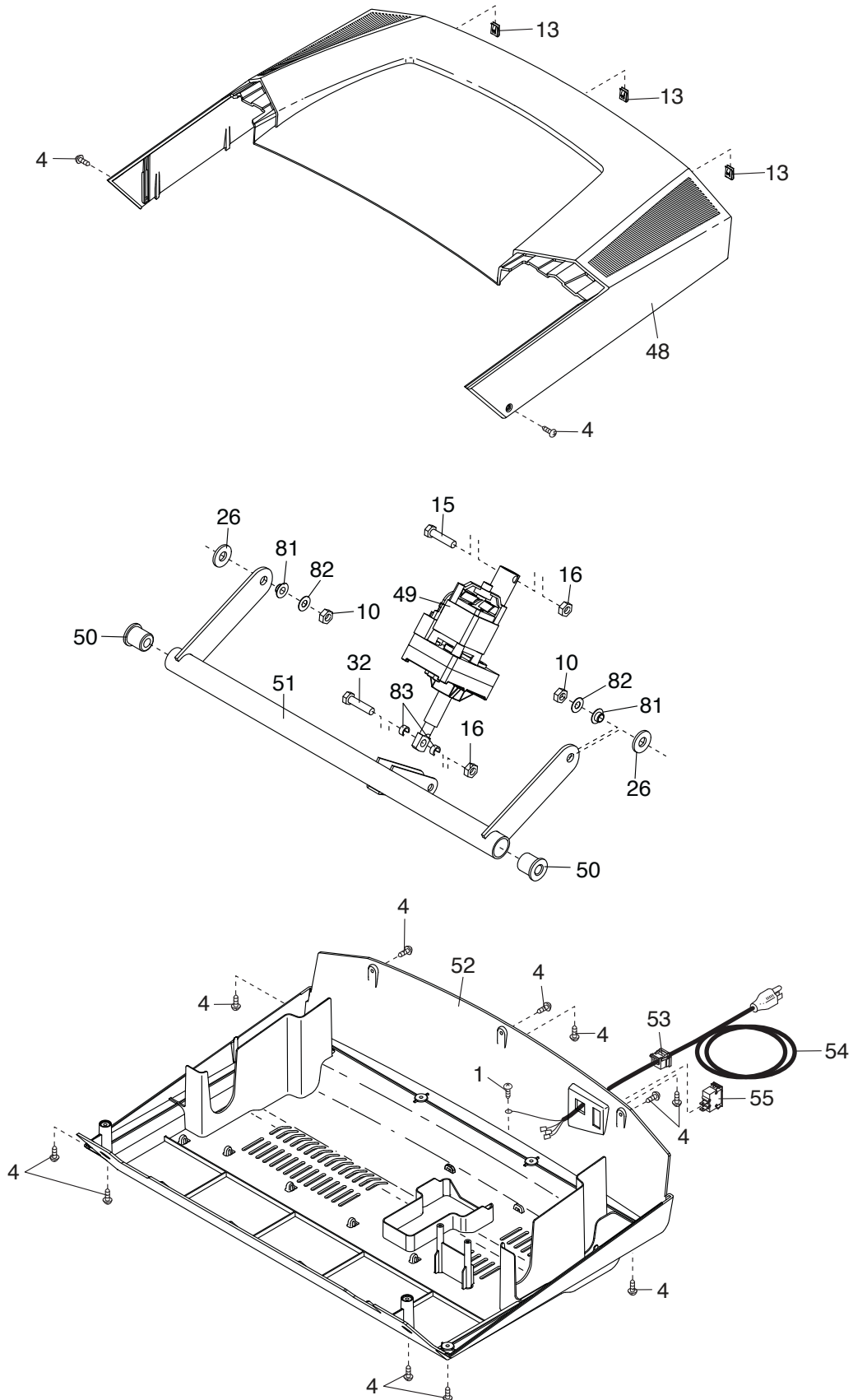

# EXPLODED DRAWING C

Model No. PFTL40916.0 R0816A

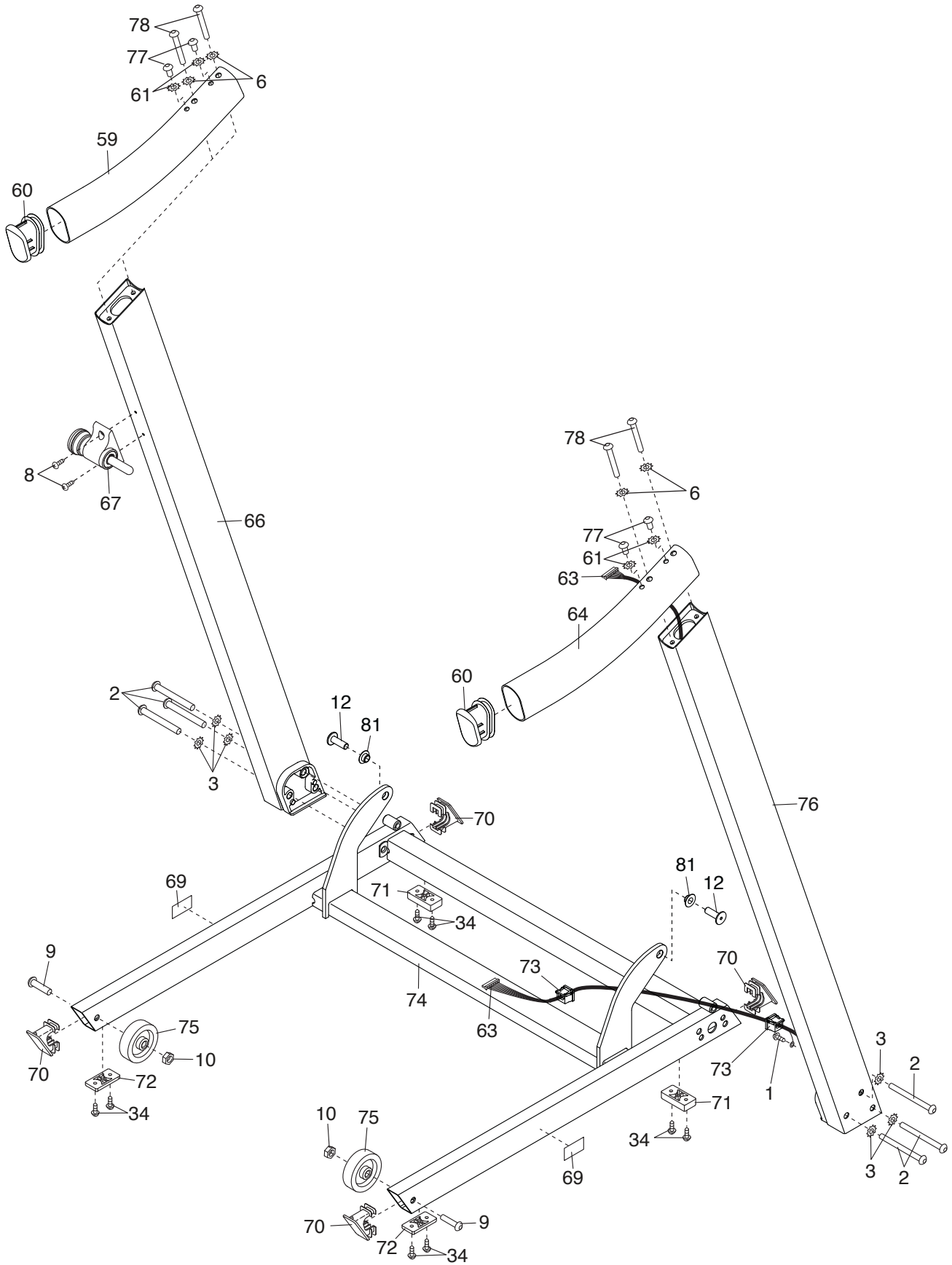

# EXPLODED DRAWING D

Model No. PFTL40916.0 R0816A

