

EXPLODED DRAWING A

Model No. PFTL40916.1 R0517A

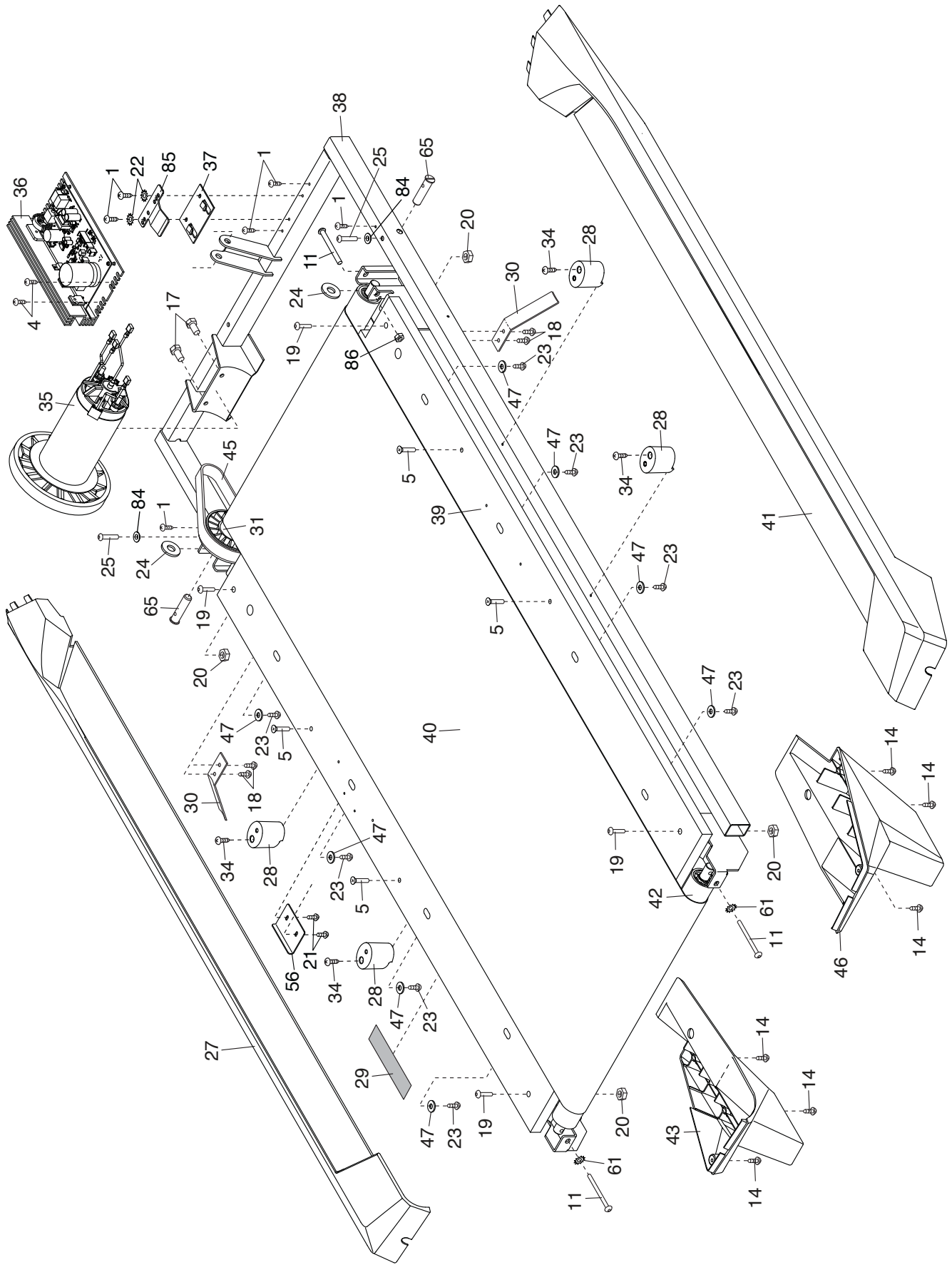

EXPLODED DRAWING B

Model No. PFTL40916.1 R0517A

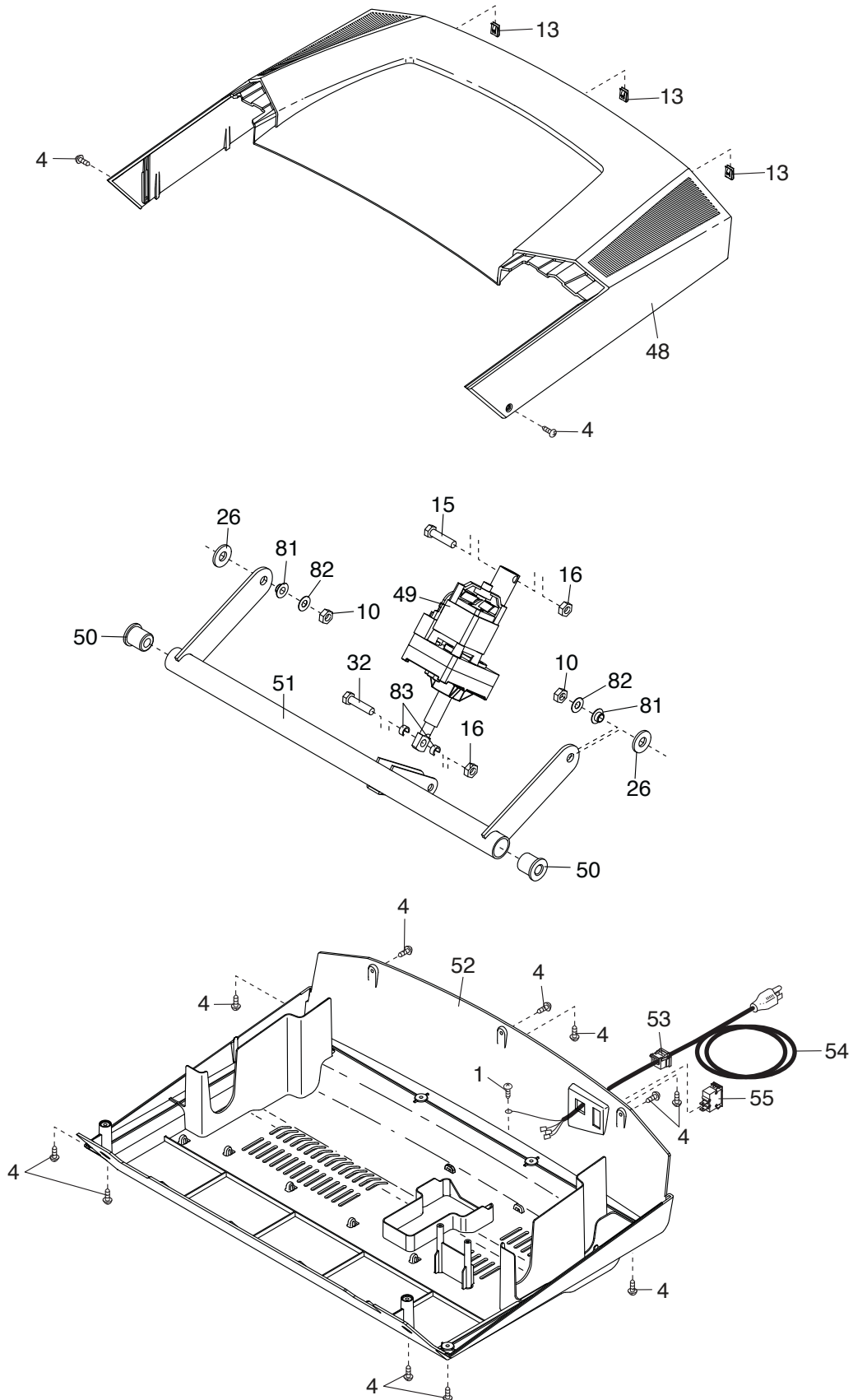

EXPLODED DRAWING C

Model No. PFTL40916.1 R0517A

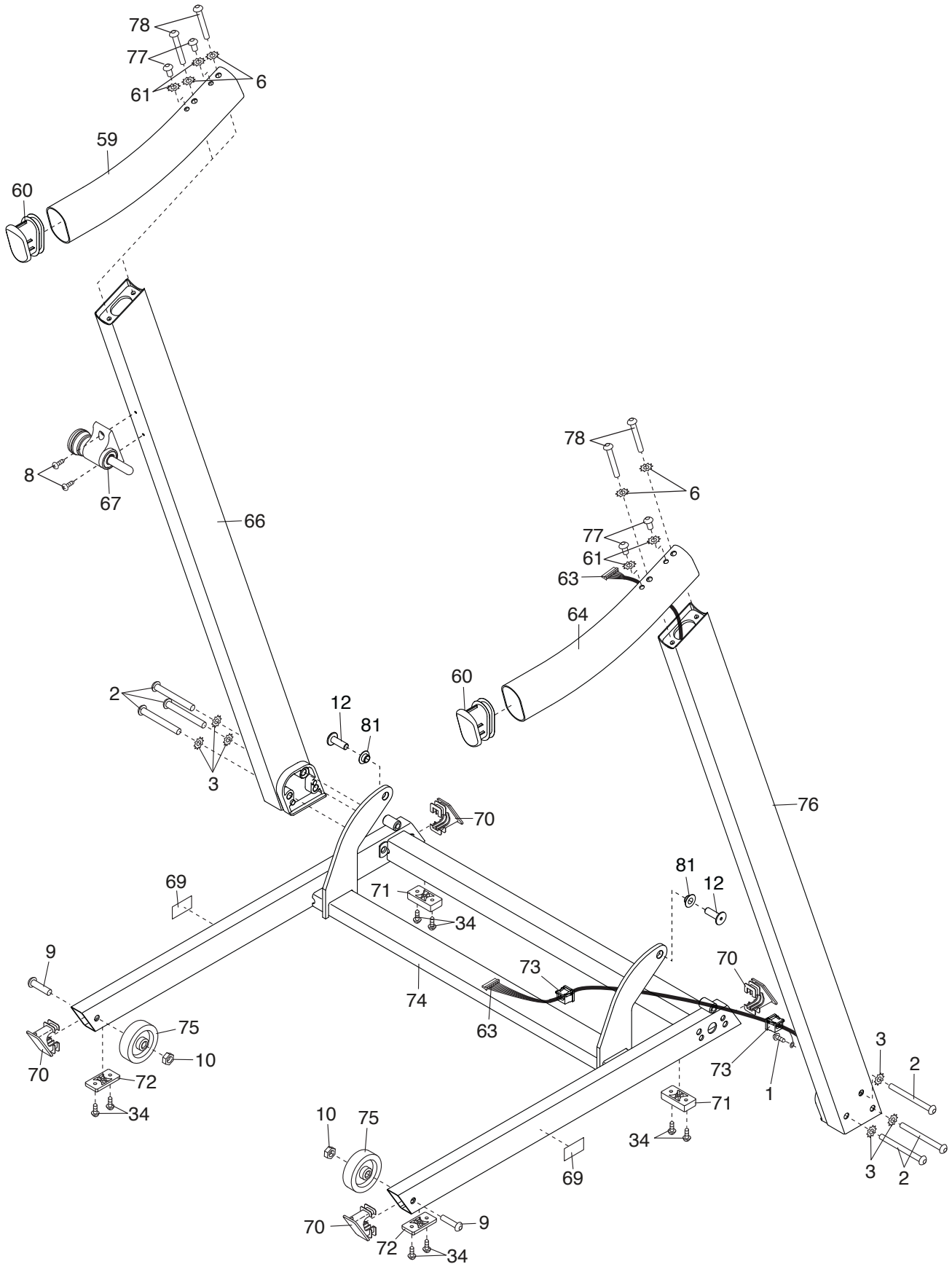

EXPLODED DRAWING D

Model No. PFTL40916.1 R0517A

